

FM 3-04.303

(FM 1-303)

**AIR TRAFFIC
SERVICES FACILITY
OPERATIONS,
TRAINING,
MAINTENANCE, AND
STANDARDIZATION**

DECEMBER 2003

DISTRIBUTION RESTRICTION:

Approved for public release; distribution is unlimited.

**HEADQUARTERS
DEPARTMENT OF THE ARMY**

**This publication is available at Army
Knowledge Online (www.us.army.mil)
and the General Dennis J. Reimer
Training and Doctrine Digital Library at
(www.adtdl.army.mil)**

Air Traffic Services Facility Operations, Training, Maintenance, and Standardization

Table of Contents

		Page
	Preface	VI
Chapter 1	Introduction	1-1
	Waivers.....	1-1
	Planning.....	1-2
	Air Traffic Control Certification and Rating.....	1-2
	Federal Aviation Administration Academy Training.....	1-2
	ATC Facility Classification.....	1-3
	Understanding this Publication.....	1-3
Chapter 2	FACILITY ADMINISTRATION	2-1
	Section I – Responsibilities and Procedures	2-1
	Duty Positions and Responsibilities.....	2-1
	Other Positions for Operating and Controlling the ATC Facility.....	2-6
	Communications Procedures.....	2-7
	Operating Initials.....	2-8
	Facility Currency/Proficiency.....	2-8
	Coordinated Universal/Local Time.....	2-10
	Procedures/Notification for Opening and Closing Facilities.....	2-10
	Standard Facility Shifts and Workweeks.....	2-10
	Emergency Manning Levels Policy (Installation Facilities Only).....	2-13
	Control and Coordination of Airfield/Heliport Areas.....	2-14
	Section II – Aircraft Accidents and Incidents	2-15
	Involvement of Aircraft.....	2-15
	Responsibilities of Shift Leader.....	2-16
	Responsibilities of ATS Leaders.....	2-16
	Accidents or Incidents Involving Radar Facilities.....	2-17
	Information Release.....	2-17
	Section III – Weather	2-18
	Cooperative Weather Watch (Installation Facilities Only).....	2-18

Distribution Restriction: Approved for public release; distribution is unlimited.

*This publication supersedes FM 1-303, dated 5 April 1993.

Chapter 3	RADAR AND FLIGHT FOLLOWING SERVICES.....	3-1
	Section I – Radar.....	3-1
	Radar Service	3-1
	Automation Program Changes (Installation Facilities Only)	3-3
	Automatic Acquisition and Termination Areas (Installation Facilities Only).....	3-3
	TPX-42/44 System	3-4
	Radar Mapping.....	3-4
	Flight Inspection Approaches.....	3-9
	Minimum Vectoring Altitude Charts.....	3-11
	Minimum Safe Altitude Warning and Conflict Alert	3-13
	Magnetic Variations of Video, Geographical, and MSAW Digital Terrain Maps	3-14
	Digital Map Verification	3-14
	Radar Beacons	3-14
	Section II – Flight Following	3-15
	Purpose	3-15
	Responsibilities	3-15
	Procedures.....	3-17
Chapter 4	FACILITY EQUIPMENT	4-1
	Equipment Layouts	4-1
	Facility Ground Inspection, Certification, and Recertification Procedures	4-3
	Radar/NAVAID Emergency Warning and Evacuation System (Installation Facilities Only).....	4-5
	Navigational Aids	4-11
Chapter 5	REFERENCE MATERIAL	5-1
	Section I – Reference Files, Charts, Diagrams, and Maps.....	5-1
	Facility Reference File.....	5-2
	Controller Reference File	5-2
	Recent Information File	5-2
	Operating Position Files	5-2
	Charts, Diagrams, and Maps	5-3
	Section II – Administrative Correspondence	5-4
	Letters of Agreement.....	5-4
	Letters of Procedure.....	5-7
	Operations Letters.....	5-10
	Facility Memorandums	5-11
	Section III – Operating Records and Forms	5-12
	Operational Hazard Report.....	5-12
	Training and Proficiency Record—Air Traffic Controller and Trainee/Controller Evaluation	5-13
	ATC Facility Personnel Status Report	5-13
	Tactical Approach Publications System.....	5-18
	ATC Maintenance Personnel Certification and Related Training Record.....	5-20
	Records Review and Retention	5-22
	Contests and Appeals.....	5-23
	GCA Operations Log.....	5-23
	Daily Report of Air Traffic Control Facility	5-25
	Air Traffic Control Position Log	5-27
	Flight Progress Strips.....	5-28

Chapter 6	INSTALLATION FACILITY TRAINING PROGRAM.....	6-1
	Program of Instruction	6-1
	Facility Training Manual.....	6-4
	Training and Proficiency Record—Air Traffic Controller	6-5
	Trainee/Controller Evaluation	6-9
Chapter 7	TACTICAL FACILITY TRAINING PROGRAM	7-1
	Program of Instruction	7-1
	Facility Training Manual.....	7-4
	Training and Proficiency Record—Air Traffic Controller	7-5
	Trainee/Controller Evaluation	7-8
Chapter 8	MAINTENANCE	8-1
	Section I – Ground Inspection	8-1
	Certification Responsibility	8-1
	Certification Procedures	8-2
	Section II – ATC Maintenance Certification Program	8-7
	Program Objectives	8-7
	Certification Responsibility and Authority	8-7
	Maintenance Technician Certification	8-8
	Theory of Operation and Performance Examinations	8-10
	Theory (Concepts) Written Examinations.....	8-11
	Section III – Records File, Forms, and Maintenance Certification	
	Requirements.....	8-14
	Records File	8-14
	Forms.....	8-15
	Section IV – Air Traffic Control and NAVAID Facility Standards.....	8-16
	General	8-17
	Environmental Control Standards for ATC and NAVAID Facilities	8-38
Appendix A	Training and Proficiency Records	A-1
Appendix B	Publication Reference Files.....	B-1
Appendix C	Facility Training Manuals.....	C-1
Appendix D	Theodolite Operations	D-1
Appendix E	Air Traffic Control Tape Transcriptions	E-1
Appendix F	Risk Management	F-1
Appendix G	Tactical Operations	G-1
Appendix H	Determining Currency Requirements (Installation Facilities Only)	H-1
	GLOSSARY	Glossary-1
	BIBLIOGRAPHY	Bibliography-1
	INDEX.....	Index-1

Figures

	Page
Figure 2-1. Message Format for an EML Report	2-14
Figure 3-1. Radar Safety Limits (PAR without a “B” Cursor)	3-6
Figure 3-2. Radar Safety Limits (PAR with “B” Cursor)	3-7
Figure 3-3. Radar Safety Limits (ASR with Digital Video).....	3-8
Figure 3-4. Radar Safety Limits (ASR with Analog Video)	3-9
Figure 3-5. PAR “A” Cursor (on Glide Path)	3-9
Figure 3-6. “B” Cursor Lower Safe Limits (on Path)	3-10
Figure 3-7. “A” Cursor Lower Safe Limits (on Path)	3-11
Figure 3-8. Sample MVA Chart.....	3-12
Figure 4-1. Certificate for Initial Facility Certification	4-4
Figure 4-2. Certification of Tapes Containing Accident Data.....	4-10
Figure 4-3. Certification of Transcription.....	4-11
Figure 4-4. Certification of Copies of Written Records	4-11
Figure 5-1. Sample Format for an FAA or a U.S. Army LOA.....	5-6
Figure 5-2. Example Format for a LOP.....	5-9
Figure 5-3. Sample Format for a Control Tower or an Airfield Operations Letter..	5-11
Figure 5-4. GCA Operations Log.....	5-25
Figure 5-5. Sample Correction Format for DA Form 3503-R.....	5-28
Figure 5-6. Sample Completed Progress Strip	5-29
Figure 8-1. ATC Maintenance Technician Certification Process	8-10
Figure A-1. Standardized ATC Record Dummy Folder	A-1
Figure A-2. Standardized ATC Record Folder	A-2
Figure A-3. DA Form 3479-R Example	A-4
Figure A-4. DA Form 3479-9-R Example.....	A-49
Figure A-5. DA Form 3479-10-R Example.....	A-51
Figure D-1. Theodolite Components.....	D-1
Figure D-2. Cutaway View of the Theodolite Optical System.....	D-5
Figure D-3. Vertical Axis Adjustment	D-7
Figure D-4. Theodolite Positioned	D-10
Figure D-5. Desired Angle Set and Theodolite Repositioned	D-11
Figure D-6. Theodolite Barrel Elevated	D-12
Figure D-7. Adjustment for Height Differences	D-13
Figure D-8. Theodolite Positioned for Zero Elevation Difference	D-14
Figure D-9. Theodolite Positioned for Known Elevation Difference.....	D-14
Figure D-10. Zero Elevation Difference Calculated	D-16
Figure E-1. Memorandum Format for Official Tape Transcriptions	E-2
Figure F-1. Sample Risk Matrix	F-5
Figure G-1. Sample Obstruction Documentation.....	G-3
Figure G-2. Radar Reflector Diagram (Left of Runway)	G-4
Figure G-3. Navigational Aid (NAVAID) Deployment Matrix.....	G-7
Figure G-4. Precision Approach Radar (GCA) Data.....	G-9

Tables

	Page
Table 2-1. Data Relative to Density Altitude Advisory Broadcast	2-19
Table 6-1. Explanation of DA Form 3479-R	6-6
Table 7-1. Explanation of DA Form 3479-R	7-5
Table 8-1. Equipment Certification Listing.....	8-16
Table 8-2. Major Equipment (ARAC).....	8-20
Table 8-3. Major Equipment (Type A and Type B Towers).....	8-22
Table 8-4. Design Drawings	8-23
Table 8-5. Power Standards.....	8-24
Table 8-6. Standard Equipment	8-24
Table 8-7. Major Equipment – ILS.....	8-25
Table 8-8. Major Equipment – GCA	8-26
Table 8-9. Electrical Power Standards	8-27
Table 8-10. Power Conditioning Requirements	8-27
Table 8-11. Major Equipment – TVOR	8-28
Table 8-12. Electrical Power Standards	8-28
Table 8-13. Major Equipment – NDB	8-29
Table 8-14. Electrical Power Standards	8-29
Table 8-15. Major Equipment	8-30
Table 8-16. Electrical Power Standards	8-30
Table 8-17. Major Equipment	8-31
Table 8-18. Electrical Power Standards	8-31
Table 8-19. Major Equipment – Installation AIC.....	8-32
Table 8-20. Space and Amenity Requirements	8-32
Table 8-21. Electrical Power Standards	8-33
Table 8-22. Pilot Controlled Airport Lighting.....	8-34
Table 8-23. Major Equipment	8-35
Table 8-24. Carpet Specifications	8-36
Table 8-25. Furniture Specifications.....	8-36
Table 8-26. Progress Strips/Strip Holders.....	8-37
Table 8-27. Critical/Noncritical Environmental Control Standards	8-39
Table B-1. Required ATC Reference Files.....	B-1
Table B-2. Required ATC Maintenance Reference Files	B-3
Table F-1. Sample Installation Risk Assessment.....	F-2
Table F-2. Sample Tactical Risk Assessment.....	F-3

Preface

This publication provides instructions, standards, and guidance to operate and manage United States (U.S.) Army air traffic control (ATC) facilities and units. It is intended for use by all Active Army, Army National Guard, U.S. Army Reserve, Department of the Army (DA) civilians, and contract personnel who perform ATC duties for the U.S. Army. All standards, policies, and procedures in this manual are mandatory, according to AR 95-2.

This field manual supplements applicable DA, Federal Aviation Administration (FAA), and International Civil Aviation Organization (ICAO) publications to be used in providing air traffic services. When the U.S. Army provides ATC services in overseas areas, deviations from these standards may be necessary to conform to foreign government regulations. Deviations shall be outlined in an agreement between one of the following—

- Theater commander and the host government.
- Host government military commanders and U.S. Army commanders.
- Host government ATC authorities and the U.S. Army commanders.
- Host government ATC authorities and U.S. Army ATC authorities.

Combat support ATC services performed to support aviation mission requirements may also dictate deviations from established standards. Such deviations shall be approved in writing by an O-6 or higher.

For more information concerning on-going ATC issues and contact numbers, refer to—

- Air Traffic Services Command (ATSCOM) Internet home page (<http://155.147.98.10/atca/home/ATCHOME.htm>).
- The U.S. Army Aeronautical Services Agency Internet home page (<http://www.usaasa.belvoir.army.mil/default.htm>).

The proponent of this publication is U.S. Army Training and Doctrine Command (TRADOC). Send comments and recommendations on DA Form 2028 (*Recommended Changes to Publications and Blank Forms*) directly to Commander, U.S. Army Aviation Center, ATTN: ATZQ-TDS-D, Fort Rucker, Alabama 36362-5000.

This publication has been reviewed for operations security considerations.

Unless this publication states otherwise, masculine nouns and pronouns do not refer exclusively to men.

Chapter 1

Introduction

The policies and procedures in this manual standardize U.S. Army ATC training, facilities, operations, management, and maintenance. The procedures in this manual dealing with operational requirements, position responsibilities, and duties are the minimum standard, unless stated otherwise. The ATC chief/senior air traffic control sergeant (ATC SR SGT)/platoon sergeant (PSG)/ATC facility chief is responsible for facility operations, quality assurance, training, and rating standards. At his discretion, he may increase any or all of the minimum requirements established by this manual. This chapter explains how to use this manual and how to request waivers to the guidance in this manual. It also defines the specific terms as they are used in this manual.

WAIVERS

1-1. All deviations from the policies outlined in this manual require the submission of a waiver. Requests for waivers shall be sent through channels to Commander, USAAVNC, ATTN: ATZQ-ATC, Fort Rucker, Alabama 36362-5265. When a waiver must be expedited, an organization may get interim approval by phone, through channels, from the Director, Air Traffic Services Command (ATSCOM) (defense switching network [DSN] 558-3007/Commercial [334] 255-3007 or Chief, Fixed Branch Support Division, DSN 558-1635).

CONTENTS	
Waivers	1-1
Planning	1-2
Air Traffic Control Certification and Rating	1-2
Federal Aviation Administration Academy Training	1-2
ATC Facility Classification	1-3
Understanding this Publication	1-3

1-2. Waivers will be submitted in memorandum format and outline the specific need, time period, and reason for exception. A risk assessment and an hourly traffic count from the previous 15-day period will be attached as supporting documentation for justification when the waiver content addresses either of the following:

- Manning.
- Position consolidation.
- Standard shifts.
- Standard workweeks.

1-3. The organization initiating the requests shall be responsible for the requests for renewal or extension of waivers. Subordinate and intermediate

commands will ensure that all requests are endorsed, or commented on appropriately, then sent to ATSCOM. All approved waivers will contain a cancellation date or condition in the final paragraph.

PLANNING

1-4. Airspace planning is required when airspace is required for training or contingency operations. The air traffic and airspace officer (AT&AO), Department of the Army regional representative (DARR), United States Army Aeronautical Service Detachment—Europe (USAASD-E) Commander, or Eighth Army (EUSA) ATC Office must be involved early to coordinate airspace requirements with the appropriate (Federal Aviation Administration [FAA]/host nation [HN]) airspace planners. Air traffic services (ATS) personnel will assist in developing an effective Army airspace command and control (A²C²) plan that will provide safe and effective use of airspace across the operational continuum. The ATS unit must coordinate with the aviation unit responsible for aircraft participating in the operation. During the initial planning stage, these ATS units must—

- Coordinate airspace use.
- Determine what letter of agreement (LOA)/letter of procedure (LOP) must be established.
- Select the equipment site.
- Perform initial terminal instrument procedures (TERPS) of the airspace.
- Determine what additional services are available/required, for example crash rescue and petroleum, oil, and lubricants (POL).

AIR TRAFFIC CONTROL CERTIFICATION AND RATING

1-5. Military personnel, DA civilians, foreign nationals, and contract personnel performing ATC duties in ATC facilities shall become qualified and facility-rated according to AR 95-2. All controllers and supervisors, both military and civilian, must meet and maintain the physical standards of AR 40-501, the Office of Personnel Management (OPM) Handbook X-118, or their official job descriptions. Foreign nationals performing ATC duties in U.S. Army facilities shall comply with the ATC physical requirements of the host nation.

FEDERAL AVIATION ADMINISTRATION ACADEMY TRAINING

1-6. During March of each year, the ATSCOM will conduct annual solicitation of Army requirements for technical training conducted by the FAA Academy. These requirements shall be identified by units and provided through command channels to the Commander, U.S. Army Aviation Center, ATTN: ATZQ-ATC, Fort Rucker, Alabama 36362-5265, not later than 1 April. The ATSCOM will present the consolidated Army requirements to the FAA Academy during the annual call to training conference.

1-7. The ATSCMO will disseminate quotas to the requesting units during September, or upon receipt from the FAA Academy. Units shall complete a DD Form 1556 (*Request, Authorization, Agreement, Certification of Training and Reimbursement*) for course attendance for each quota received or return the quota to the Commander, U.S. Army Aviation Center, ATTN:

ATZQ-ATC, Fort Rucker, Alabama 36362-5265, not later than 30 days before the class start date.

ATC FACILITY CLASSIFICATION

- 1-8. ATC facilities are grouped into five major classifications:
- Airfield/Heliport/Airport traffic control tower (ATCT).
 - Ground-controlled approach (GCA).
 - Army airspace information center (AIC).
 - Army approach control (nonradar) (AAC).
 - Army radar approach control (ARAC).

UNDERSTANDING THIS PUBLICATION

TERMS

1-9. To understand this publication, the reader must be familiar with the terms used. The Glossary explains the terms, acronyms, and abbreviations, used in this field manual.

SYMBOLS

1-10. The diagonal (/) indicates “or” or “and.” For example, orders/handbooks may mean orders or handbooks or may mean orders and handbooks.

WORD MEANINGS

1-11. The meanings for some of the words used in this manual are given below.

- Shall or an action verb in the imperative mood means a procedure is mandatory.
- Should means a procedure is recommended.
- May or need not means a procedure is optional.
- Aircraft means the airframe or crewmembers or both.
- ATC-certified means the person graduated from a formal ATC school and possesses an air traffic control specialist (ATCS) certificate.
- Position-qualified (PQ) means a *controller* passed all phases of training for a particular operating position (such as local control [LC], ground control [GC], and precision approach radar [PAR]) and received a satisfactory evaluation on DA Form 3479-1-R (*Trainee/Controller Evaluation*).
- Facility-rated means a controller completed all phases of training and possesses the appropriate certification for a particular facility.
- Installation facility is defined by the major Army command (MACOM), regardless of the equipment used (see glossary).
- A tactical facility is considered tactical until a facilities request is approved by the MACOM and validated by ATSCOM. (See AR 95-2, chapter 14.)

APPENDIXES

1-12. The following appendixes are in this manual:

- Appendix A – Training and Proficiency Records

- Appendix B – Publication Reference Files
- Appendix C – Facility Training Manuals
- Appendix D – Theodolite Operations
- Appendix E – Air Traffic Control Tape Transcriptions
- Appendix F – Risk Management
- Appendix G – Tactical Operations
- Appendix H – Determining Currency Requirements (Installation Facilities Only)

Chapter 2 Facility Administration

This chapter outlines the processes and procedures used for ATC facility administration. Section I addresses mandatory supervisory and control positions and the associated responsibilities as outlined in AR 95-2. These operating positions shall be manned, and the functions performed, only by ATC personnel qualified to perform those duties. The requirements and procedures for day-to-day facility operations are also explained in this section. ATC facilities shall use local standing operating procedures (SOPs) to supplement these requirements when necessary. Section II discusses processes, procedures, and responsibilities pertaining to aviation accidents and incidents. Section III addresses weather-related processes and procedures.

SECTION I – RESPONSIBILITIES AND PROCEDURES

DUTY POSITIONS AND RESPONSIBILITIES

QUALITY ASSURANCE NCO

2-1. Quality assurance (QA) personnel are the battalion and higher, commanders' subject matter experts in all matters pertaining to air traffic control. The QA noncommissioned officer (NCO)—

- Serves as ATCS/control tower operator (CTO) examiner in accordance with AR 95-2 and this manual.
- Ensures training and facility operations are in accordance with published directives and SOPs.

CONTENTS

Section I – Responsibilities and Procedures.....	2-1
Duty Positions and Responsibilities.....	2-1
Other Positions for Operating and Controlling the ATC Facility.....	2-6
Communications Procedures	2-7
Operating Initials.....	2-8
Facility Currency/Proficiency	2-8
Coordinated Universal/Local Time	2-10
Procedures/Notification for Opening and Closing Facilities	2-10
Standard Facility Shifts and Workweeks	2-10
Emergency Manning Levels Policy (Installation Facilities Only)	2-13
Control and Coordination of Airfield/Heliport Areas.....	2-14
Section II – Aircraft Accidents and Incidents.....	2-15
Involvement of Aircraft.....	2-15
Responsibilities of Shift Leader	2-16
Responsibilities of ATS Leaders.....	2-16
Accidents or Incidents Involving Radar Facilities.....	2-17
Information Release	2-17
Section III – Weather	2-18
Cooperative Weather Watch (Installation facilities Only).....	2-18

- Conducts evaluations as required.
- Ensures terminal instrument procedures (TERPS) are complete and accurate in accordance with TM 95–226 (tactical only).

ATC CHIEF/ATC SENIOR SERGEANT/PLATOON SERGEANT

2-2. The ATC chief/ATC SR SGT/PSG supervises and manages all ATC facilities under his control at an airfield, heliport, or field site. He also—

- Provides liaison on matters of ATC and airspace with the AT&A; DARR; FAA; MACOMs; local post, camp, or station commander; and representatives of other units, agencies, or commands.
- Ensures that ATC systems are operationally acceptable.
- Ensures that facilities collect and safeguard data on aircraft mishaps, emergencies, or violations.
- Ensures that assigned ATC personnel maintain currency.
- Ensures that facilities set up and conduct training and rating programs according to prescribed regulations.
- Ensures TERPS are complete and accurate in accordance with TM 95-226 (tactical only).
- May serve as ATCS/CTO examiner in accordance with AR 95-2 and this manual.

ATS A²C² LIAISON

2-3. Liaison personnel are responsible for assisting the airspace control authority (ACA) to establish and maintain the Army A²C². This A²C² system is linked with the ACA by communications, standardized procedures, acquisition systems, and liaison. The A²C² element in the area of operations—

- Coordinates and integrates airspace use.
- Coordinates airspace with other users.
- Maintains ATS overlays within the command post.
- Assists in developing and maintaining the airspace utilization map.
- Staffs' requests for special-use airspace.
- Identifies and resolves conflicts between airspace users.
- Develops plans, procedures, and SOPs and disseminates them to appropriate agencies.
- Advises higher headquarters and subordinate units of significant airspace activities and the impact that airspace command and control (C²) will have on operations.
- Disseminates information concerning enemy air defense.
- Coordinates selected identification (ID) requirements and identification friend or foe (IFF) procedures for Army aircraft.
- Coordinates and disseminates information and changes in coordinating altitude.
- Coordinates requirements for flight plans, air defense, and airspace control measures.
- Maintains and disseminates the location and status of airfields, navigational aids (NAVAID), landing zones (LZ), and pickup zones (PZ) in the area of operations.

- Coordinates requirements for airfield terminal control zones and other A²C² elements.
- Coordinates and disseminates ATS and air defense (AD) procedures to be used by aviation units.
- Maintains and disseminates airspace control measure (ACM) information.

ATC FACILITY CHIEF

2-4. The ATC facility chief is a facility-rated ATCS who manages the applicable ATC facility and personnel. The ATC facility chief also—

- Ensures that the facility operates according to military and FAA rules and regulations.
- Develops and maintains a facility training program (FTP) and facility training manual (FTM).
- Develops TERPS (tactical only).
- May serve as ATCS/CTO examiner in accordance with AR 95-2 and this manual.
- Ensures that all controllers meet the physical standards of AR 40-501, AR 95-2, DA Pamphlet (Pam) 611-21, the OPM Handbook X-118, their official job descriptions, and/or local/host nation requirements.
- Ensures the operational readiness of facility equipment and associated NAVAIDs.
- Maintains a current file of pertinent regulations, manuals, charts, maps, and training material in accordance with appendix B and AR 95-2.
- Ensures that assigned personnel maintain currency.
- Maintains custodial control of all facility forms, records, and publications and ensures their accuracy, completeness, and distribution.
- Initiates and maintains a facility duty schedule.
- Recommends trainees for PQ/facility rating.
- PQs trainees.

ATC TRAINING SUPERVISOR

2-5. The ATC training supervisor is a facility-rated ATC specialist designated by the facility chief. The training supervisor—

- Plans, schedules, directs, and supervises the facility training of assigned ATC personnel.
- Supervises and conducts classroom and self-study training.
- Develops local course material, training aids, and control scenarios to supplement DA, USAAVNC, and FAA training programs.
- Evaluates and analyzes the capabilities and progress of the ATC personnel assigned to that facility.
- Maintains training records.
- Ensures the position qualification of trainees.
- Recommends trainees for PQ/facility rating.
- PQs trainees.

- Recommends to the ATC facility chief those controllers who require proficiency or remedial training. The training supervisor bases his recommendations on both personal observations and shift leader (SL) comments.
- May serve as ATCS/CTO examiner in accordance with AR 95-2 and this manual.

DATA SYSTEMS OFFICER (INSTALLATION ONLY)

2-6. The data systems officer (DSO) is responsible to the facility chief for integrating, operating, and modifying ATC automation systems. A DSO should be appointed when the complexity of the automation system requires three or more full-time data system specialists. The DSO also—

- Maintains familiarity with all control scenarios.
- Develops computer programs for the facility.
- Represents the ATC chief/ATC facility chief during meetings or negotiations concerning automation.
- Prepares the automation status reports, notices, and correspondence necessary for managing and operating the automation system.
- Prepares recommendations, justifications, and estimates for automation system upgrades.
- Analyzes procedures; traffic flow; and data processing, transfer, and display information.
- Supervises the data system specialists.

DATA SYSTEMS SPECIALIST (INSTALLATION ONLY)

2-7. The data systems specialist (DSS) ensures that the facility computer and related equipment function properly. He also—

- Performs systems analyses.
- Develops and modifies the program.
- Ensures program accuracy.
- Coordinates with adjacent automated facilities.
- Identifies the operational or procedural impact of program patches and changes.

SHIFT LEADER

2-8. During the SL's tour of duty, he is responsible to the facility chief for the efficiency of facility operations. He also performs his normal ATC duties in addition to those of the SL. The SL—

- Assigns and directs all phases of the subordinates' work.
- Makes sure personnel receive on-the-job training.
- Assists and advises controllers during emergency situations.
- Maintains facility records.
- Makes sure personnel are current and proficient.
- Notifies search and rescue facilities of aircraft in distress and provides assistance and advice.
- Delegates responsibility to subordinates and assists the training supervisor.

- Evaluates the operational effectiveness of facility systems, subsystems, and equipment.
- Records and reports outages and takes action to correct discrepancies.
- Recommends trainees for PQ.
- May serve as ATCS/CTO examiner in accordance with AR 95-2 and this manual.

CONTROLLER-IN-CHARGE

2-9. The ATC facility chief or SL should rotate the controller-in-charge (CIC) assignment among the facility potential supervisors. This procedure exposes the controller to supervisory duties and responsibilities of the SL and is not an attempt to preempt the military rank structure. A CIC will be designated to assume duties of the SL as outlined below.

- When supervisory personnel leave the facility or are off duty, the ATC facility chief or SL shall designate a CIC for the period the supervisor is absent. Assigning a CIC assures that coordination and cooperation will continue when the SL is not available.
- The CIC shall assume all duties and responsibilities of the SL except recommending trainees for position qualification. He also performs his normal ATC duties in addition to those of the SL.
- The CIC shall sign as the SL on the bottom of DA Form 3502-R (*Daily Report of Air Traffic Control Facility*). (See chapter 5.)

CONTROL TOWER OPERATOR AND ATCS EXAMINERS

2-10. CTO and ATCS examiners shall be designated and assume duties as outlined below.

- Military or civilian CTO and ATCS examiners shall be designated according to AR 95-2, FAAO 7220.1, and this manual. AR 95-2 explains how to request examiner designations. The facility-rated controllers meeting the requirements of AR 95-2 may be recommended for designation as examiners.
- Primary and alternate ATCS examiners may be appointed per facility or tactical system as long as not more than two examiners are appointed per facility/tactical system.
- During the planning stages, leaders must consider the possibility that issuance of temporary FAA CTO certificates will be required for temporary locations.
- Examiners shall administer CTO and ATCS facility rating tests according to Federal aviation regulations (FAR), Part 65; FAA Orders 7220.1 and 8080.1; and this manual. They conduct the tests properly and complete, maintain, and submit the related forms and records according to procedures in FAAO 7220.1 and FAAO 8080.1. CTO and ATCS examiners—
 - Maintain test security.
 - Develop and maintain the facility rating tests.
 - Make sure applicants meet eligibility requirements.
 - Issue temporary CTO certificates and sign ATCS certificates.
 - Administer all prescribed written and practical tests for the facility-rating exam.

- Maintain a record of ratings issued (by name, date, and type) and retain the record in facility files.
- Complete and submit the necessary certification of forms according to FAAO 7220.1, FAAO 8080.1 and AR 95-2 (installation only).
- Report testing or certification irregularities or problems, as appropriate, to the PSG/ATC facility chief, DARR office, or QA.

ATC MAINTENANCE CHIEF

2-11. The ATC maintenance chief is responsible for all ATC equipment maintenance. Duties include, but are not limited to, the following:

- Coordinate maintenance-related issues, such as LOA, on-call rosters, and NAVAID scheduled maintenance with the ATC chief/ATC SR SGT/ PSG or ATC facility chief.
- Ensure maintenance facilities are maintained according to applicable military and FAA publications and standards.
- Ensure the qualifications of maintenance personnel.
- Coordinate ATC equipment maintenance with support and supported units.
- Establish a maintenance training and certification program for the local facility.
- Coordinate facility configuration changes with the ATC chief or PSG and higher headquarters.
- Maintain, “as built” diagrams and drawings for ATC facilities and equipment in accordance with AR 95-2.
- Maintain a current file of pertinent regulations, manuals, and training material in accordance with appendix B.

OTHER POSITIONS FOR OPERATING AND CONTROLLING THE ATC FACILITY

2-12. Operating and controlling the ATC facility require these other positions and responsibilities in addition to the supervisory positions in the paragraphs above.

- *Local control (LC)*. The LC issues information and clearance for properly separating and sequencing aircraft under his control.
- *Ground control (GC)*. The GC issues information and instructions for the orderly movement of traffic (aircraft, vehicles, and pedestrians) on the movement area.
- *Flight data (FD)*. The FD receives, posts, and relays flight data clearances and messages and assists in facility operations, as directed.
- *Coordinator (CI) (installation only)*. The CI coordinates the flow of air traffic between other positions or facilities, as required.
- *Clearance delivery (CD) (installation only)*. The CD delivers clearances to departing aircraft. The function of the CD is separate from that of the GC or FD.
- *Flight following (FF)*. The FF issues information and advisories to arriving, departing, and en route aircraft and monitors the flight progress of aircraft. The FF also receives, posts, and relays progress

reports and posts information to flight data strips, boards, charts, and tactical situation maps.

- *Departure control (DC)*. Applying radar or nonradar standards, the DC expedites the movement of departing aircraft. The DC provides separation between successive departures and between departing and arriving aircraft.
- *Arrival control (AC)*. Applying radar or nonradar standards, the AC expedites the movement of arriving aircraft. The AC provides separation between successive arrivals and between arriving and departing aircraft.
- *Approach control (AP)*. Applying radar or nonradar standards, the AP provides for the separation and sequencing of instrument flight rules (IFR) aircraft operating within a designated area of jurisdiction.
- *Airport surveillance radar (ASR)*. The ASR provides for the radar sequencing and separation of aircraft vectored to intercept the final approach courses for handoff to precision approach radar or for the conduct of a surveillance approach.
- *Precision approach radar (PAR)*. The PAR issues instructions to the pilot based on the position of the aircraft relative to the final approach course, glide path, and distance from touchdown. The PAR also monitors certain nonradar instrument approaches.

COMMUNICATIONS PROCEDURES

2-13. The SL on duty is responsible for all communications emanating from the facility. The ATC chief/ATC SR SGT/PSG/ATC facility chief shall ensure that periodic checks are made to detect and prevent superfluous or unauthorized transmissions, as discussed in the following paragraphs:

- The SL takes action to detect and prevent radio or telephone transmission of false or deceptive communications and obscene, indecent, or profane language. The SL is also responsible for detecting unauthorized or unassigned IDs and preventing willful or malicious interference with other communications.
- Besides normal ATC transmissions, the facility may need to transmit third-party messages about the safety of aircraft operations or the preservation of life or property. Such transmissions are authorized on ATC radio communications channels. Controller personnel or persons concerned with the emergency may handle these transmissions. Noncontroller personnel may be given access to ATC facilities, if control instructions are not issued and their transmissions can be interrupted to continue ATC services.
- ATC facilities may relay non-ATC instructions only when no other source of communication is available and the transmissions will not interfere with ATC instructions. When it appears that such broadcasts may affect the control of air traffic, ATC personnel shall immediately notify the ATC chief/ATC SR SGT/PSG/ATC facility chief.

OPERATING INITIALS

2-14. The ATC chief/ATC SR SGT/PSG/ATC facility chief shall assign controllers and maintenance personnel individual, two-letter operating initials. The facility chief and maintenance chief shall maintain a list of operating initials for all assigned personnel on a facility memorandum. Except where signatures are required, controllers shall use the assigned operating initials on all interphone systems and facility forms and records.

FACILITY CURRENCY/PROFICIENCY

2-15. An installation controller is current and may exercise the privileges of his rating when he meets the requirements in appendix H.

2-16. Tactical controllers shall meet the following requirements for proficiency.

- Each time the controller is deployed, on a real world mission or FTX, to provide air traffic services after the initial rating, he shall be given a written or oral proficiency check for the deployment-specific portions of the facility training manual (FTM). This training may be given prior to the deployment.
- If the controller has not set up or deployed and worked traffic with his/her assigned facility within the last 30 days, they shall also be given an evaluation using DA Form 3479-1-R (*Trainee/Controller Evaluation*), to evaluate proficiency. The evaluation shall be administered on all control positions. The evaluation will last long enough to provide a reliable performance sample. It must be satisfactorily completed before a controller assumes position responsibility without direct supervision.
- Proficiency evaluations are initially administered by the ATCS examiner to the controllers with the most experience for that type of facility. After at least two of the most experienced rated controllers are found to be proficient by the ATCS examiner, the remaining controllers may be evaluated for proficiency by those controllers. These evaluations shall be recorded on DA Form 3479-1-R and the results entered in section V of DA Form 3479-R. The proficiency evaluation shall be maintained for one year on the right side of the controllers record.
- Controllers that are assigned to installation facilities and are concurrently assigned to a like tactical facility (7A, TTCS, etc.) are not required to receive a proficiency evaluation if they meet the currency requirements outlined in appendix H. This does not preclude the requirements to set up the tactical equipment for proficiency training at least once every 30 days. Setting up the equipment shall be recorded in section III of DA Form 3479-R as proficiency training.

Notes: If there is not a “rated controller” who is current/proficient in a facility, the examiner(s) responsible for that facility assumes all responsibility and signs on behind the controller(s) on the DA Form 3503-R (*Air Traffic Control Position Log*). The examiner(s) will perform direct one-on-one supervision to the non-current/proficient controller(s) until they can be given a satisfactory evaluation (DA Form 3479-1-R); the form will be maintained for one year.

(Tactical only). The proficiency evaluations do not have to be administered on the deployment or FTX site. They may be administered anywhere and anytime prior to the controller assuming ATC responsibilities without direct one on one supervision and is within 30 days of the deployment/FTX

2-17. Remedial training shall be noted on DA Form 3479-R (*Training and Proficiency Record—Air Traffic Controller*), if additional training is needed to regain proficiency because of an unsatisfactory evaluation. The amount of training devoted to regaining proficiency should depend on the number and type of previous ratings the controller holds. Individuals unable to regain proficiency shall be processed in accordance with AR 95-2.

RESTRICTING THE USE OF MILITARY PERSONNEL OUTSIDE THEIR MOS

2-18. When planning normal work periods and shift schedules, supervisors must consider the time air traffic controllers and maintenance personnel devote to other military duties. Temporarily assigning controllers and maintenance personnel to duties outside their MOS can adversely affect both flight safety and professional development. Supervisors must retain the expertise necessary for safe control of air traffic. Therefore, supervisors should restrict the use of ATC personnel outside their MOS to essential military duties.

RECORDING THE TIME PERSONNEL WORK OUTSIDE THEIR MOS

2-19. For personnel working outside their MOS (not available for duty; for example special duty [SD] or medical disqualification), supervisors shall make an entry in the Remarks section of DA Form 3479-6-R (*Air Facility and Personnel Status Report*). (See chapter 5.)

NONCONTROLLER PERSONNEL IN ATC FACILITIES

2-20. The ATC chief/ATC SR SGT/PSG/ATC facility chief shall keep to a minimum the number of non-ATC personnel in an ATC facility. The chief shall be the final authority on the admittance of non-ATC personnel to the facility and the number permitted at any one time. (In the chief’s absence, the SL or CIC will assume this responsibility.)

MEDICAL RESTRICTIONS TO ATC DUTIES

2-21. If a supervisor determines that a controller’s physical or mental health is questionable, he shall relieve the controller of ATC duties. The supervisor shall refer the controller to a flight surgeon/medical examiner for an evaluation and a ruling. If a controller is receiving a substance or medical procedure that is likely to provoke an adverse systemic reaction, he shall be restricted from ATC duties. The controller will not perform ATC duties until

declared fit in accordance with AR 40-501. AR 40-8 addresses the factors to consider and the appropriate medical restrictions to ATC duty.

COORDINATED UNIVERSAL/LOCAL TIME

2-22. All ATC facilities shall use Coordinated Universal Time (UTC) and date in all operational activities. Local time shall be used for facility duty schedules, daily traffic counts, and other administrative forms and correspondence.

PROCEDURES/NOTIFICATION FOR OPENING AND CLOSING FACILITIES

2-23. The installation commander establishes the ATC facility's hours of operation (installation only). The ATC unit commander establishes a tactical ATC facility hours of operation per mission requirement. Facilities that operate less than 24 hours per day, 7 days per week shall establish procedures for opening and closing. They shall coordinate these procedures with airfield operations and/or the ATC facility having instrument flight rules (IFR) jurisdiction. These procedures shall also be included in a LOA or operations letter. When part-time facilities open or close, they shall broadcast the service they are resuming or terminating.

2-24. If airfield operations continue to function when the ATC facility is closed, The ATC facility and base/flight operations shall exchange pertinent flight data before the facility opens or closes. The facility shall publish its hours of operation in the appropriate flight information publications (FLIP)/notices to airmen (NOTAM)/aviation procedures guide (APG).

STANDARD FACILITY SHIFTS AND WORKWEEKS

2-25. Facility shifts and workweeks must be designed in accordance with policy guidance in AR 95-2. Scheduled shifts are a facility "planning" tool to meet operational requirements and may or may not reflect the individual controllers "actual" hours of duty. Requirements may necessitate a regularly "scheduled" shift (for example day, swing, mid, A, B, C exceeding 8 hours).

2-26. The battalion/group commander, and airfield commander in the absence of an ATS unit structure, may authorize, in writing, a facility to schedule an up-to-10-hour shift for a period not to exceed 60 days. All waivers approved by the commander shall be kept on file within the facility and a copy shall be forwarded to the Commander, U.S. Army Aviation Center, ATTN: ATZQ-ATC, Fort Rucker, Alabama 36362-5265

2-27. If a facility must operate with extended shifts beyond 60 days, a written request for waiver shall be prepared and sent through the installation commander to ATSCOM for approval. The request will indicate the purpose, justification, projected time period of extended hours, and the recommended solution(s) for the waiver.

2-28. Battalion/group commanders responsible for ATS/ATC operations may direct up to 12-hour tactical shifts to support contingencies, field training, deployment for field training, and exercises when operating from a temporary location that does not involve the control of civil aircraft. The application of 12-hour shifts may include 12 hours of controlling duties; the window for performing controlling duties shall not exceed 16 hours.

Note: An 8-hour uninterrupted rest period shall occur prior to shift in both installation and tactical operations. Controllers shall not be scheduled for any duties during periods of uninterrupted rest.

2-29. FAR, Part 65.47 applies to all persons performing installation air traffic control duties for the U.S. Army. For Maximum hours of duty refer to AR 95-2. Requirements may necessitate a regularly “scheduled” workweek in excess of 40 hours.

2-30. The battalion/group commander, and airfield commander in the absence of an ATS unit structure, may authorize, in writing, a facility to schedule an up-to-a-50-hour workweek for a period not to exceed 60 days. All waivers approved by the commander shall be kept on file within the facility; a copy shall be forwarded to the Commander, USAAVNC, ATTN: ATZQ-ATC, Fort Rucker, Alabama 36362-5265.

2-31. Facility shifts and workweeks must be designed in accordance with policy guidance in AR 95-2. If a facility must operate with extended workweeks beyond 60 days, a written request for waiver shall be prepared and sent through the installation commander to ATSCOM for approval. The request will indicate the purpose, justification, projected time period of extended workweeks, and the recommended solution(s) for the waiver.

HOURLY TRAFFIC COUNT (INSTALLATION ONLY)

2-32. Facility managers should compile hourly traffic counts to assist in the effective management of manpower and staffing requirements. The facility hourly traffic count data shall be according to the categories set forth in chapter 5. ATC facility and personnel status report shall accompany all requests for waivers to standard shifts, standard workweeks, or minimum staffing. The data shall be from the previous 15-day period.

SHIFT REQUIREMENTS

Qualified Controller for Each Operating Position

2-33. Shift duty and actual shift manning shall provide a qualified controller for each operating position in the facility. This does not preclude reducing the actual shift manning to the minimum stated in the following paragraphs when flying activities are less than normal, such as on holidays and weekends.

Consolidation of Operating Positions

2-34. The ATC chief/ATC SR SGT/PSG/ATC facility chief may permit consolidation of operating positions; either one may approve the performance of more than one function by a rated or PQ controller. No less than two controllers shall be present for duty in the control tower, approach control tower (nonradar), GCA, AIC, and ARAC. One of them shall be facility-rated and the other PQ in at least one position. A facility memorandum shall identify those positions that cannot be combined with another.

Jointly Operated Facilities (Installation Only)

2-35. Jointly operated facilities, such as an AIC and ARAC, need not meet the shift requirements of both facilities. However, the controllers must be

cross-trained and, as a minimum, PQ in an operational position of the other facility; for example, when the AIC is located within the ARAC. At least two controllers must be on duty; this is a total requirement for both facilities, not two controllers for each of the jointly operated facilities. The AIC facility-rated controller must be PQ at an ARAC position, and the ARAC facility-rated controller must be PQ at an AIC position.

POSITION ASSIGNMENTS

2-36. Only ATC personnel who are qualified to perform the duties as outlined in AR 95-2 and this manual shall man the operating positions. Controllers shall be assigned to positions as required by traffic, equipment, and individual qualifications.

2-37. Non-PQ trainees shall not be assigned to positions on which they are not qualified unless they are under direct supervision of facility rated controllers. In addition, PQ controllers shall not be assigned to more than one position at a time, unless they are qualified on both positions.

2-38. Facility-rated controllers providing direct one-on-one supervision are directly responsible for operating the position. Non-PQ trainees shall not be assigned to more than one operating position at a time. During the facility-rating evaluations, the examiner signs on the DA Form 3503-R behind the controller evaluated. Noncurrent or nonproficient, facility-rated controllers shall not be assigned to a position unless given direct one-on-one supervision by current facility-rated controllers.

2-39. At the discretion of the SL, non-PQ trainees may conduct precision or surveillance approaches during IFR conditions under certain circumstances. They may conduct these approaches if—

- Direct one-on-one supervision is maintained.
- Direct communications override is available at the position of operation.
- Weather conditions are acceptable (not less than a 500-foot ceiling or one-mile visibility).

TRANSFER OF POSITION RESPONSIBILITY

2-40. Position responsibility shall be transferred according to FAAO 7110.65 and appropriate facility directives. All controllers, including supervisors, shall know how to perform the duties of any position to which they may be assigned before they assume the responsibility. Each controller shall also—

- Read the recent information file, DA Form 3502-R, and any other operational data that the ATC chief/ATC SR SGT/PSG/ATC facility chief, SL, or CIC may specify.
- Obtain a briefing on communications, traffic and airfield conditions, equipment outages, and current and forecast weather.
- Accept responsibility for the position only after ensuring that the briefing is complete and all questions about the operation of the position have been resolved.

2-41. The relieving controller and the controller being relieved shall share equal responsibility for the completeness and accuracy of the position-relief briefing. The ATC chief/ATC SR SGT/PSG/ATC facility chief shall provide a

tailored checklist of the equipment and conditions that will likely be a factor at each position during relief periods.

EMERGENCY MANNING LEVELS POLICY (INSTALLATION FACILITIES ONLY)

2-42. Emergency manning level (EMLs) shall reflect the minimum number of facility-rated and PQ personnel required to provide services for the hours of operation necessary to support the primary mission. It is based on—

- 48-hour workweek per controller.
- Exclusion of nonqualified controllers.
- Combined positions of operation wherever practicable.
- Risk assessment.

2-43. The following formula is used to determine EMLs: Daily hours operational X number of operational positions X number of days operational each week divided by maximum hours a controller can work in one week (48 hours) = EML.

Example. 16 hours of operation daily X 2 operational positions X 5 days operation per week = 160 divided by 48 = 3.3. (For EML purposes, the value is rounded up to the next whole number.) In this case, the EML is 4.

2-44. Current EMLs shall be validated by the respective MACOMs, and reviewed and updated annually.

2-45. After the EMLs of the ATC facility has been validated, the post, camp, or station commander will be advised, in writing, of the EMLs of his facilities. Every effort will be made to anticipate EMLs. The USAAVNC commander (address below) and the post, camp, or station commander will be advised through channels as far in advance as possible that a facility is anticipated to be at or below the EML.

2-46. ATC facilities may be operated at EMLs for a period not to exceed 60-days. If assigned and attached rated and PQ controller strength does not increase during this period, services or hours of operation must be reduced. When the rated and PQ controller strength falls below the EML, services or hours of operation shall be curtailed immediately. The reduction in services or hours of operation shall remain in effect until the EML is attained.

2-47. Notification that services or hours of operation have been curtailed is sent through command channels to Commander, U.S. Army Aviation Center, ATTN: ATZQ-ATC, Fort Rucker, Alabama 36362-5265. Figure 2-1 shows the format for an EML report, page 2-14.

Title: EML Report
Facility and location:
Services and hours of operation to be curtailed if the EML extends beyond the 60-day period:
Expected implementation date of the curtailment:
Specific reasons for the proposed curtailment:
Services remaining and the proposed hours of operation:
Estimated date that normal services and hours of operation should resume:
Action implemented or planned:

Figure 2-1. Message Format for an EML Report

2-48. If corrective action cannot be taken in time to avoid the curtailment, the post, camp, or station commander shall be notified of the anticipated reduction in ATC hours of operation or services. On the date the curtailment is effective and again on the date normal operations resume, a supplemental report shall be submitted through channels to Commander, U.S. Army Aviation Center, ATTN: ATZQ-ATC, Fort Rucker, Alabama 36362-5265.

CONTROL AND COORDINATION OF AIRFIELD/HELIPORT AREAS

2-49. The ATC chief/ATC SR SGT/PSG/ATC facility chief shall coordinate closely with airfield management to establish written procedures for ensuring the most efficient use of runways. They also ensure positive control and coordination of personnel, ground vehicles, and aircraft on or near taxiways, runways, and landing areas. Personnel in or near these areas shall maintain two-way radio communications with the control tower to the maximum extent possible and shall be familiar with tower light gun signals. These procedures shall be developed in an operations letter.

AIRPORT ADVISORY SERVICE

2-50. An airport advisory service may be provided at locations without an operational control tower. This service does not require air traffic controllers. Flight operations personnel providing airport advisory services shall not use air traffic control instructions. Airport advisory services are provided to arriving and departing aircraft and are limited to—

- Wind direction and speed.
- Favored runway (not runway in use).
- Altimeter setting.
- Pertinent known traffic.
- Pertinent known field conditions.
- Airport taxi routes and traffic patterns.
- Authorized instrument approach procedures.

2-51. The above information is advisory in nature and does not constitute an ATC clearance. Such phrases as “cleared for takeoff” and “cleared to land” shall not be used. Any phraseology that can be construed, as directive in

nature shall not be used, for example “Enter right traffic for runway three six, number two follow the UH-60 on right base”. FAAO 7110.10 contains additional information about airport advisory services.

MAINTENANCE PERSONNEL POLICY

Scheduling Personnel for Duty

2-52. Certified ATC maintenance personnel shall be scheduled for duty during normal duty hours, Monday through Friday. However, such factors as equipment outages, mission requirements, maintenance schedules, and the number of assigned personnel may require the scheduling of maintenance personnel at times other than during normal duty hours.

Procedures for Recalling ATC Maintenance Personnel

2-53. The ATC chief/ATC SR SGT/PSG/ATC facility chief shall coordinate with the maintenance chief to develop written procedures for recalling ATC maintenance personnel if ATC or NAVAID equipment fails. These procedures shall outline who (by name) must respond, what types of failures require a recall, and who (for example, facility chief or SL) is responsible for initiating the recall.

Note: ATC equipment with backup systems or NAVAIDs that do not provide the only means of an IFR approach to the active runway normally would not require a recall of maintenance personnel. However, factors to consider are the amount of time before maintenance personnel arrive for scheduled duty, current and forecast weather conditions, and aircraft traffic.

Rosters

2-54. Rosters of on-call personnel shall be readily available to controllers and maintenance personnel.

SECTION II – AIRCRAFT ACCIDENTS AND INCIDENTS

INVOLVEMENT OF AIRCRAFT

2-55. Components of the Army ATC system become involved in an aircraft accident or incident in various ways. The involvement may result from—

- Irregularities or deviations from established procedures by pilots. These situations require special handling by controllers and result in the delay or re-sequencing of other aircraft.
- Operational errors involving equipment failure, personnel procedures, or system components. These errors, either individually or in combination, result in deviations from established ATC standards.
- Near collisions reported by the pilot of an aircraft involved in the incident. When a facility, service, or NAVAID is suspected to have been involved in an aircraft accident or incident, ATC must act immediately. ATC shall provide continuing safe, orderly, and expeditious movement of all air traffic operating under the jurisdiction of the ATC facility. In addition, ATC shall obtain

accurate and complete information on which to base a detailed investigation. The responsibilities following an aircraft accident or incident are outlined below.

RESPONSIBILITIES OF SHIFT LEADER

2-56. The SL shall—

- Notify the ATC chief/ATC SR SGT/PSG/ATC facility chief and other designated personnel of the accident or incident.
- Request a local weather observation, unless there has been an intervening meteorological aviation report (METAR) or special observation (SPECI).
- Record all appropriate details, including the local weather observation, on DA Form 3502-R (see chapter 5).
- Mark and safeguard the recording tapes that are (or may be) pertinent to the accident and handle them according to chapter 4 of this publication. In case of an incident, such as an emergency or a complaint about ATC services that does not result in an accident, removal of recorder tapes before the normal rotation time is unnecessary.

Note: It is extremely important that ATC personnel immediately inform the local weather personnel of each emergency or aircraft mishap. When notified of an emergency, the weather station must intensify the weather watch to ensure the aircraft in distress receives the maximum weather support. ATC personnel must notify the weather station of an aircraft mishap immediately. Thus, they can take the official weather observation and annotate the recording instruments as closely as possible to the actual time of the accident.

RESPONSIBILITIES OF ATS LEADERS

2-57. As soon as possible after notification of an accident or incident, the ATC chief/SR SGT/PSG/ATC facility chief, training supervisor, SL, or CIC shall—

- Relieve the controller for physical and psychological evaluation by the local medical officer or flight surgeon if there is any indication that the controller contributed to the accident or incident. The controller shall obtain a clearance from the local medical officer or flight surgeon before returning to duty. The controller shall be transported to the local medical facility according to AR 385-95.
- Obtain a written statement about the incident or accident from all controllers and supervisory personnel involved. Written or taped records pertaining to an aircraft accident shall be retained for a minimum of 6 months. Written or taped records pertaining to an aircraft incident shall be retained for a minimum of 30 days.
- Examine the condition of the equipment, along with technically certified maintenance personnel, to determine whether it could have contributed to the accident or incident.
- Notify the chain of command. When an aircraft accident/incident occurs and any part of a unit or ATC facility is known or suspected to have had involvement, the Director, ATSCOM and the Director,

USAASA, will be notified within 24 hours of accident/incident. Within three working days, a follow-up notification will be provided by facsimile to ATSCOM and USAASA (see website for phone numbers). The notification will include the following information:

- Date/time of accident/incident.
- Number/type aircraft involved.
- Number of injuries/fatalities.
- Brief synopsis of events to include ATC involvement.
- Actions taken.
- A point of contact by name, position, and telephone number to obtain additional information.

Note: Additional instruction pertaining to facility actions shall be contained in the ATC facility position binder.

ACCIDENTS OR INCIDENTS INVOLVING RADAR FACILITIES

2-58. When an accident or incident involves, or is suspected to have involved, radar equipment, the facility shall discontinue radar service until a flight check is performed. An exception to this policy would be during IFR conditions when aircraft can neither land using other NAVAIDs nor proceed to an alternate landing area. In this situation, the facility shall not terminate radar service if the pilot has been informed about the radar equipment and concurs in its use.

INFORMATION RELEASE

2-59. No controller shall give interviews, make statements, or release any written or recorded information to news agencies or unauthorized personnel or organizations without consulting the ATC chief/ATC SR SGT/PSG/ATC facility chief. Information on an aircraft accident, incident, or alleged violation of any kind shall not be released outside official Army channels without approval of the Commander, USAASA. The airfield commander and ATC/maintenance chief/ATC SR SGT/PSG/ATC facility chief are responsible for compiling this information. The names and Social Security numbers of personnel involved will be treated as restricted information. The unit commander may approve release of information outside of the organization to other Army elements, after consultation with the Staff Judge Advocate (SJA). Also, the unit commander, after consultation with the SJA and Public Affairs Office (PAO), may approve Army press releases. Request for information outside of Army channels will be referred to Commander, U.S. Army Aeronautical Agency, ATTN: Airspace Division, Bldg 1466, Suite N319, Fort Belvoir, VA 22060-5582.

Note: Headquarters, Department of the Army Deputy Chief of Staff, G3 is the release or denial authority for Freedom of Information Act (FOIA) requests. Commander, USAASA serves as the DCS, G3 Executive Agent for the U.S. Army regarding airspace, aeronautical information, air traffic control, and flight procedures policy.

SECTION III – WEATHER

2-60. Despite the value of the latest official weather observation, controllers must advise aircraft of current weather information and visual observations. They also must inform local weather personnel of each in-flight emergency or aircraft mishap. This section explains the requirements and procedures for providing these services.

COOPERATIVE WEATHER WATCH (INSTALLATION FACILITIES ONLY)

2-61. The cooperative weather watch is an observation program in which air traffic controllers and other nonweather personnel assist in monitoring weather conditions. The LOA between ATC agencies and the appropriate air weather service (AWS) must include local watch requirements and procedures. Air traffic controllers shall maintain a cooperative weather watch at all times according to AR 115-10, AR 115-11, and this manual.

TOWER VISIBILITY OBSERVATIONS

2-62. Although tower visibility observations (TVO) are *limited*, they are no less important than the METAR, SPECI, and local observations that weather personnel take. The accuracy and timeliness of TVOs are critical to the safety and efficiency of aircraft operations and to the protection of military resources.

- As advisories. TVOs are advisories unless weather station personnel verify them or unless the individuals taking the observations have been certified to make official weather reports. This information may include thunderstorm location and movement and rapidly deteriorating visibility. Tower controllers must also advise terminal radar facilities of any observed phenomena not in the current weather report.
- As support to the cooperative weather watch program. Tower controllers must relay TVOs to weather station personnel to support the cooperative weather watch program. This requirement is particularly important during severe weather and when conditions observed by nonweather personnel and those reported in the current weather observation are different. The local situation and weather observation site location influence how the weather station reports or relays information. The station will issue a new observation or include reports of differing conditions, such as runway visual range (RVR) and prevailing visibility, in an official weather observation (METAR, SPECI, or local). The local weather unit and the organizations to which certified non-weather personnel are assigned will establish the criteria and procedures for weather reporting. ATC facility chiefs shall contact the nearest weather station to visit and

review regulations concerning weather observation, reporting, and personnel training.

2-63. Tower facilities shall perform TVOs at the request of the local weather station or airfield commander. Facilities that perform TVOs shall develop a LOA between the ATC facility and the weather station. The LOA shall state the weather elements to be reported, responsibilities, and coordination procedures. Air Force weather stations, for example, normally publish these requirements in regulations or supplements.

2-64. All controllers shall complete initial qualification (Q) weather certification at each facility before starting PQ training. They shall renew their weather certification no later than the anniversary month of their previous certification. As part of these certifications, the ATC chief/ATC SR SGT/PSG/ATC facility chief shall ensure that comprehensive training is given to tower controllers by weather personnel on tower (prevailing) visibility. Tower visibility training shall include definitions, visibility and sector determination criteria and procedures, and reporting procedures. The results of initial (Q) and annual certification (P) shall be entered on DA Form 3479-R in section III. Required entries in section III include the date training was completed and the total training time given. The name of the organization conducting the weather training will be entered under the remarks section. If a test is given, the results shall be entered on DA Form 3479-R in section IV. If remedial training is required it will be completed as previously outlined, except an “R” will indicate the type of training given.

2-65. In accordance with AR 115-10 (AFJI 15-157), local weather service authorities will provide a practical training program to certify air traffic controllers as limited weather observers. If no servicing weather station exists, the requesting agency shall make sure limited weather observation (LWO) training is provided. Controllers shall perform weather observations as a secondary function; their primary function is ATC.

BROADCAST OF DENSITY ALTITUDE ADVISORY

2-66. When the temperature reaches a certain level, ATC facilities at Army airfields (AAF) and heliports with field elevations of 2,000 feet mean sea level (MSL), or above, shall broadcast a density altitude advisory to departing and arriving aircraft. Table 2-1 shows the temperatures and elevations at which the advisory will be broadcast.

Table 2-1. Data Relative to Density Altitude Advisory Broadcast		
<i>Field Elevation (ft MSL)</i>	<i>Temperature (°F)</i>	<i>Temperature (°C)</i>
2,000 to 2,999	85 and higher	29 and higher
3,000 to 3,999	80 and higher	27 and higher
4,000 to 4,999	75 and higher	24 and higher
5,000 to 5,999	70 and higher	21 and higher
6,000 to 6,999	65 and higher	18 and higher
7,000 to 7,999	60 and higher	16 and higher

RELAY OF WEATHER OBSERVATIONS TO THE TOWER

2-67. The local weather service shall relay weather observations to the tower. Controllers shall post observations received by telephone on notepads or on the reverse side of flight strips. Observers and controllers will use the standard weather symbols and abbreviations.

Weather Data

2-68. The airfield weather status (IFR or visual flight rules [VFR]) shall be posted to DA Form 3502-R when daily operations begin. As it changes during the day, the status is again posted to the form.

2-69. Controllers do not need to retain weather data received over recorded voice lines or automated systems. However, they shall retain, with the DA Form 3502-R, weather data received over unrecorded voice lines and data copied on notepaper. Both the observer and the controller initials shall be posted on each observation received.

Visibility Checkpoint Charts

2-70. All control tower facility chiefs shall prepare visibility checkpoint charts as outlined in chapter 5. They will use these charts to report tower visibility and to observe changes in the reported visibility. When the official report and the tower observation differ, the tower shall report the tower visibility to the weather station and the terminal radar facility. The lesser of the surface (official) and tower visibility shall be used for aircraft operations. Tower visibility may include the entire surface area or any portion of the area. For example, "Tower visibility is two and one-half miles" or "Tower visibility to the south is one-half mile." When tower visibility is less than four miles and differs from the reported values, it should be included in the Remarks section of an official weather observation. Tower visibility is also transmitted to all arriving and departing aircraft. This is not necessary if it is included in a current ATIS broadcast (installation facilities only).

Chapter 3 Radar and Flight Following Services

This chapter provides guidance for conducting radar and flight following services and is not an attempt to preclude the responsibilities of either a radar or airspace information center from adhering to the guidance in other chapters of this field manual (FM) or other regulations.

SECTION I – RADAR

RADAR SERVICE

3-1. Radar service shall be provided only when the controller has a suitable target and is satisfied that the presentation and the equipment performance are adequate for the service provided. A target normally should be received on every scan from the final approach fix to the missed approach point.

DAILY PERFORMANCE CHECKS

3-2. On a day-to-day basis, each radar controller determines if the quality of his radar display is satisfactory for ATC purposes. Radar performance quality is determined by comparing identified targets against data obtained during the commissioning flight check. The controller and maintenance personnel also may determine the quality of the radar display jointly through minimum performance criteria. Radar controllers shall be familiar with the commissioning flight check and minimum performance data. The ATC chief/ATC SR SGT/PSG/ATC facility chief shall make this information available to the controllers.

CONTENTS

Section I – Radar	3-1
Radar Service	3-1
Automation Program Changes (Installation facilities Only).....	3-3
Automatic Acquisition and Termination Areas (Installation facilities Only)	3-3
TPX-42/44 System.....	3-4
Radar Mapping	3-4
Flight Inspection Approaches	3-9
Minimum Vectoring Altitude Charts	3-11
Minimum Safe Altitude Warning and Conflict Alert	3-13
Magnetic Variations of Video, Geographical, and MSAW Digital Terrain Maps	3-14
Digital Map Verification	3-14
Radar Beacons	3-14
Section II – Flight Following	3-15
Purpose	3-15
Responsibilities.....	3-15
Procedures	3-17

3-3. At the beginning of each facility workday, or as soon as practicable thereafter, the SL shall ensure that each radar controller completes the necessary radar alignments and adjustments according to the appropriate manuals. The daily radar performance check shall be part of routine equipment checks. Controllers shall accomplish this check once each shift, unless lack of traffic makes it impossible. For radar performance checks, airport surveillance radar systems shall conform to the following tolerances.

Coverage

3-4. A usable target return will be maintained along the entire airway/route or arrival or departure control route for which radar service is provided. A usable target return is defined as one that is not missed on more than two consecutive scans or three seconds (azimuth or elevation). Tracking accuracy along these routes will be within the fix/map accuracy (as described in the following paragraphs). Radar services for arrival or departure routes exist between the normal handoff point and a point one-half mile from the end of the runway.

Fix/Map Accuracy

3-5. Radar accuracy must be such that reporting aircraft are within a circular area about the fix. The radius of this area is three percent of the fix-to-station distance or 500 feet (1,000 feet for the air traffic control radar beacon system [ATCRBS]) whichever is greater. Tolerances are not assigned for a fixed target ID or a moving target indicator.

Secondary Airports

3-6. For secondary airports, radar services exist at the point where the aircraft leaves or enters the bottom fringe of the radar coverage pattern. The vertical coverage pattern will meet the operational requirements of the facility in both the horizontal (the distance from antenna to the outer fringe) and the vertical planes. No tolerance is assigned horizontally; however, a complete radar commissioning is required for a vertical acceptance check.

Surveillance Approaches

3-7. The radar used for surveillance approaches shall present a usable target return through the final course. Surveillance approaches must meet the following tolerances, or they will be canceled.

- *Straight in approach to runway.* The surveillance approach course line will coincide with the runway centerline extended. Maximum error left or right of the runway edges shall not exceed 500 feet at the missed approach point.
- *Circling approach to an airport.* If it is more advantageous to do so, the approach course may be aligned to the center of the airport or to any portion of the usable landing area. For helicopters, the final approach may be established to a missed-approach point not farther than 2,600 feet from the center of the landing area. For a point-in-space approach, the final approach may be established to a point from which flight to the landing area must be accomplished by visual reference to a prescribed route along the surface. In each instance, approach guidelines will be provided to the prescribed missed-approach point. Guidance accuracy must be within three percent of the distance between the selected delivery point and the radar antenna.

DISPLAY INDICATORS (INSTALLATION FACILITIES ONLY)

3-8. Radar approach, departure control, and VFR radar advisory functions normally will be conducted from a radar approach control. A direct-view or digital bright radar indicator tower equipment (DBRITE) display may be used. Radar approach and departure control functions may be performed from the tower cab if—

- Not more than two radar-operating positions are required and DBRITE display indicators are used on a permanent basis.
- More than two operating positions are required and DBRITE display indicators are installed on an interim basis pending the establishment of a radar approach control.
- Temporarily, radar display indicators other than DBRITE display indicators are installed.

3-9. If a scan conversion DBRITE is used, the standard installation will consist of one operational and one standby scan conversation unit. The range and center selected for the master DBRITE display will be the same on all slaved display indicators.

3-10. If the radar operating positions concerned require individual beacon decoding, each DBRITE display position will need a separate scan conversion unit. A DBRITE display installed in the tower cab for local control shall be positioned where it can be viewed easily from the local controller's normal sitting or standing position. At least one direct-view indicator must be retained if the surveillance-approach capability would be lost when only the scan conversion DBRITE display is used.

AUTOMATION PROGRAM CHANGES (INSTALLATION FACILITIES ONLY)

3-11. Facility chiefs of automated facilities shall review each site program bulletin (terminal) issued by FAA air traffic services or the U.S. Air Force and local program patches to determine their impact on operations and procedures. When necessary, a facility directive will be issued to describe functional changes and resulting procedural changes. When a facility has a DBRITE hosted by an FAA or Air Force radar automation system, the facility chief shall coordinate with the host facility chief to determine the impact of a site program bulletin.

AUTOMATIC ACQUISITION AND TERMINATION AREAS (INSTALLATION FACILITIES ONLY)

3-12. The ATC chief/ATC SR SGT/PSG/ATC facility chief shall—

- Establish automatic acquisition areas for arrivals and overflights at ranges that permit automatic acquisition of targets before the air route traffic control center (ARTCC)/automated radar terminal system (ARTS)-to-ARTS automatic handoff area when the center is in the radar data processing (RDP) mode.
- Coordinate with adjacent automated facilities to ensure that computer handoffs will be initiated only after the aircraft are within their facility automatic acquisition area.

Note: Coordination may not be feasible because of airspace assignment. Therefore, a facility directive shall prescribe the use of an appropriate procedure according to FAAO 7110.65 to confirm the identity of all aircraft handed off before ARTS acquisition.

- Establish automatic acquisition areas for departing aircraft that are one mile or less from the end of the runway.
- Establish automatic termination areas
 - For arriving aircraft that are one mile or less from the runway threshold.
 - At satellite airfields, for arriving aircraft that are at the minimum radar coverage range or altitude, whichever is greater.
- Prescribe, in a facility directive, the operating position responsibility for determining if an automatic acquisition of a departure track has occurred.

3-13. Distances greater than those specified above may be authorized when operational conditions dictate. FAA concurrence may be obtained through the DARR.

TPX-42/44 SYSTEM

3-14. The FTM shall specify the discrete codes assigned to each operating position from the code subsets allocated to the facility. The ATC chief/ATC SR SGT/PSG/ATC facility chief shall develop local procedures, operating instructions, and training materials to standardize intra-facility operations of the TPX-42/44 system. Before the TPX-42/44 is used, its operational status shall be verified. When the system is released to maintenance technicians, TPX-42/44 data shall not be used and the affected facilities shall be informed of scheduled and unscheduled shutdowns.

RADAR MAPPING

3-15. The minimum radar-mapping capability for ATC services, if required, is a five-channel mapper. Except as noted in the paragraph 3-18 (*Airport Surveillance Radar*), radar facilities shall not use grease pencil markings, plastic tape, compass rose grid lines, range marks, or other innovations to replace a video map or map overlay.

3-16. As necessary, facility chiefs shall coordinate with adjacent radar facilities and the responsible authority for flight checks to ensure the accuracy and adequacy of common reference points on radar maps when they are used to provide ATC services. To reduce scope clutter and increase operational efficiency, data on video maps should be limited to—

- Handoff points.
- Reporting points.
- Major obstructions.
- Range accuracy marks.
- Airfields and heliports.
- Airway/route centerlines.
- Map alignment indicators.

- Hospital emergency landing areas.
- Radio navigational and approach aids.
- Special-use tracks such as scramble, recovery, and standard instrument departure (SID).
- Runway centerline extensions to a minimum of six miles.
- Prominent geographic features such as islands and mountains.
- Minimum vectoring altitude (MVA) in hundreds of feet, for example, 25 equals 2,500 feet.
- Boundaries such as controlled special-use areas, terminal buffer areas, or outer fix holding-pattern areas.
- Airports immediately outside the area of jurisdiction but within the airspace used to receive radar handoffs and depicted by the facility having jurisdiction over the airspace.

3-17. The guidance in the previous paragraph will assist controllers in making emergency airport recommendations when in-flight emergencies occur near facility boundaries. There is no intent to establish criteria for airfield depiction. Because facilities having jurisdiction depict airfields on their video maps, those same airfields shall be depicted on the adjacent facility video map. FAAO 7110.65 provides additional information on airfield depiction.

AIRPORT SURVEILLANCE RADAR

3-18. To provide surveillance approaches, ASR indicators shall be equipped with a video mapper or electronic cursor as a reference to the runway centerline extended. On radar systems not equipped to provide this service, a map overlay may be used. This centerline reference shall be extended to a minimum of six miles or the final approach fix whichever is greater. The use of grid indicator lines on the face of the surveillance scope to form the ASR final approach course is not authorized. The facility chief shall prepare a chart with recommended altitudes for surveillance approaches. This chart shall be maintained in the facility and made readily available to controllers.

RADAR (ASR/PAR) SAFETY LIMITS

3-19. These safety limits serve as a minimum standard for controllers to determine if an aircraft can execute a safe approach using the smallest aircraft target. They are established in relation to the azimuth and elevation cursors. The limits begin at the point the aircraft reaches the final approach fix or intercepts the glide path and end at the missed approach point/decision height (DH). (See figures 3-1 through 3-4.) To supplement FAAO 7110.65, the following standards shall be utilized as a basis for instituting a program within facilities conducting ASR/PAR approaches.

3-20. The following standards shall be used with radar systems that do not have a “B” cursor on the PAR display. (See figure 3-1.) Once the aircraft begins descent and progresses along the final approach, ensure that—

- Elevation:
 - From five to three miles, the target does not exceed more than one-half target length above or below the elevation cursor.

- From three miles to one mile, the target does not exceed more than one-quarter target length above or below the elevation cursor.
 - From one mile to DH, the target must be touching the elevation cursor.
 - From DH to touchdown (TD), as advisories only, the target should be touching the elevation cursor.
- Azimuth:
 - From five to three miles, the target does not exceed more than two target lengths left or right of azimuth cursor.
 - From three miles to one mile, the target does not exceed one target length left or right of azimuth cursor.
 - From one mile to DH, the target must be touching the azimuth cursor.
 - From DH to TD, as advisories only, the target should be touching the azimuth cursor.

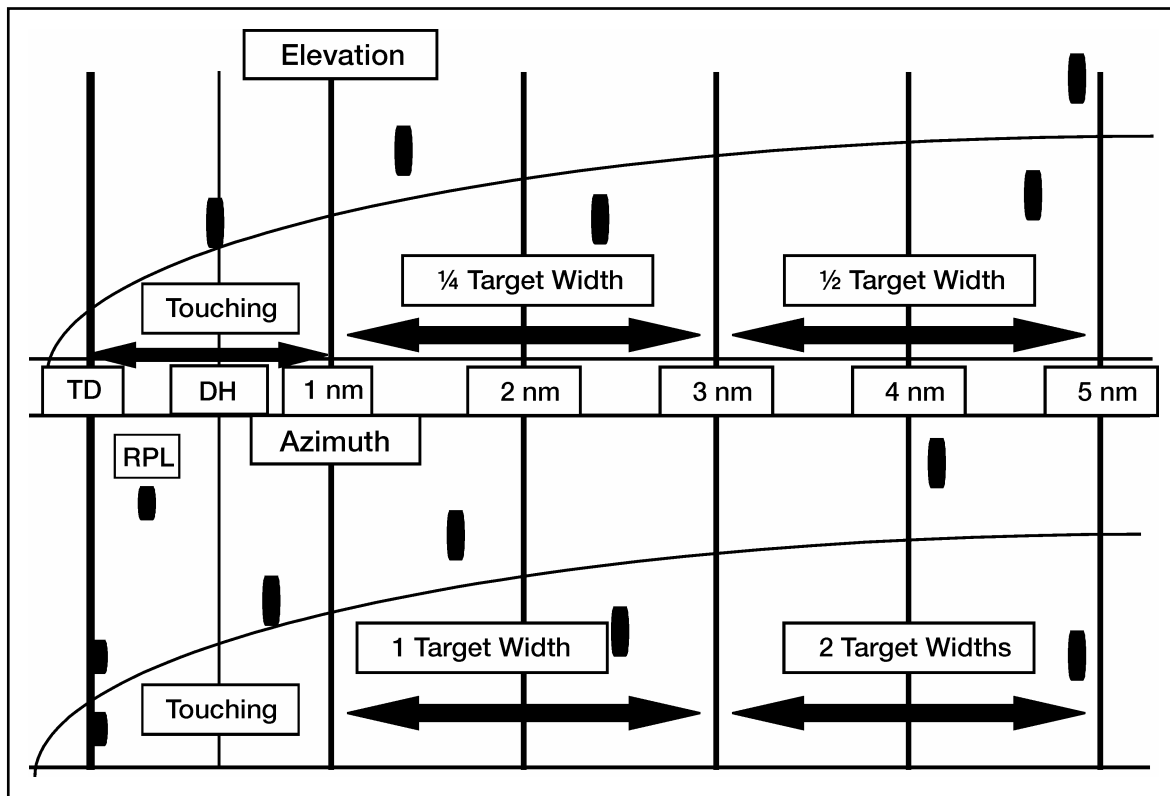

Figure 3-1. Radar Safety Limits (PAR without a “B” Cursor)

3-21. The following standards shall be used with radar systems that have a “B” cursor on the PAR display. (See figure 3-2.) Once the aircraft begins descent and progresses along the final approach, ensure that—

- Elevation:
 - From five to three miles, the target does not exceed the “B” cursor (below) or more than one-half inch above the elevation “A” cursor.
 - From three miles to one mile, the target does not exceed the “B” cursor (below) or more than one-quarter inch above the elevation “A” cursor.
 - From one mile to DH, the target must be touching the elevation “A” cursor.
 - From DH to TD, as advisories only, the target should be touching the elevation “A” cursor.
- Azimuth:
 - From five to three miles, the target does not exceed more than one inch left or right of azimuth cursor.
 - From three miles to one mile, the target does not exceed one-half inch left or right of the azimuth cursor.
 - From one mile to DH, the target must be touching the azimuth cursor.
 - From DH to TD, as advisories only, the target should be touching the azimuth cursor.

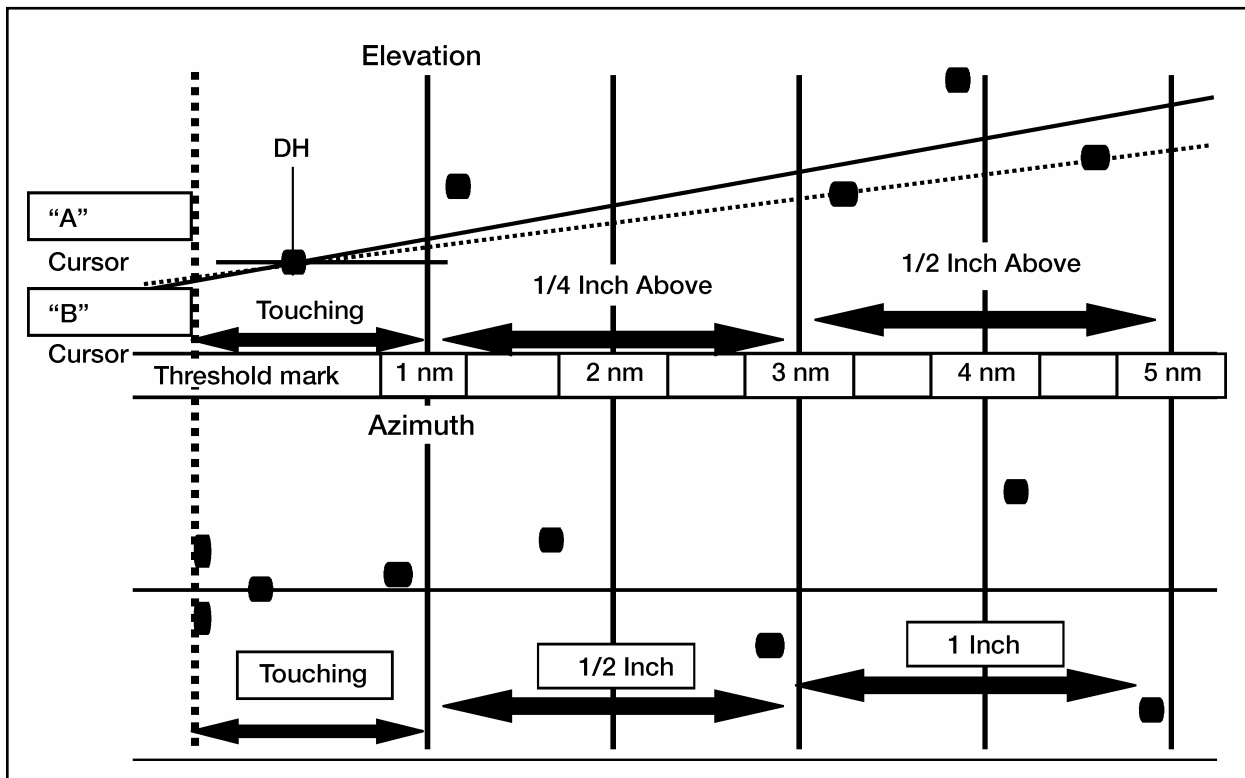

Figure 3-2. Radar Safety Limits (PAR with “B” Cursor)

3-22. The following standards shall be used when applying the elevation failure procedures of FAAO 7110.65, if authorized, on the digital radars currently being fielded such as the air traffic navigation, integration, and

coordination system (ATNAVICS) and installation PAR (fixed base precision approach radar [FBPAR]). (See figure 3-3.) Once the aircraft begins descent and progresses along the final approach ensure that—

- ASR:
 - From five to three miles, the target does not exceed one inch left or right of azimuth cursor.
 - From three miles to one mile, the target does not exceed one-half inch left or right of azimuth cursor.
 - From one mile to missed approach point (MAP), the target must be touching the azimuth cursor.

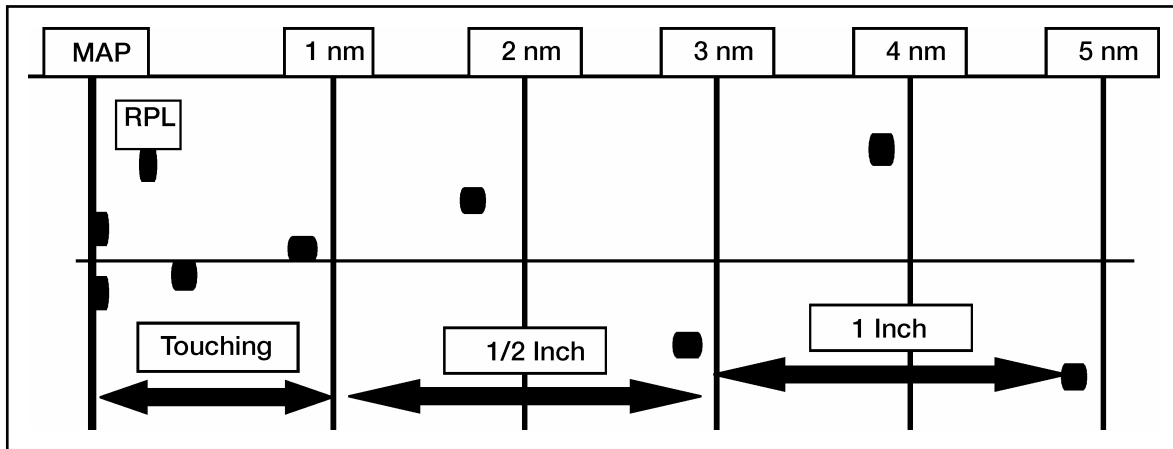

Figure 3-3. Radar Safety Limits (ASR with Digital Video)

3-23. The following standards shall be used during ASR approaches on the older analog radar systems currently in use worldwide such as the TPN-18/18A, and FPN-40 (authorized when using PAR azimuth to apply the elevation failure procedures of FAAO 7110.65) (see figure 3-4). Once the aircraft begins descent and progresses along the final approach ensure that—

- ASR:
 - From five to three miles, the target does not exceed more than two target widths left or right of azimuth cursor.
 - From three miles to one mile, the target does not exceed one target width left or right of azimuth cursor.
 - From one mile to MAP, the target must be touching the azimuth cursor.

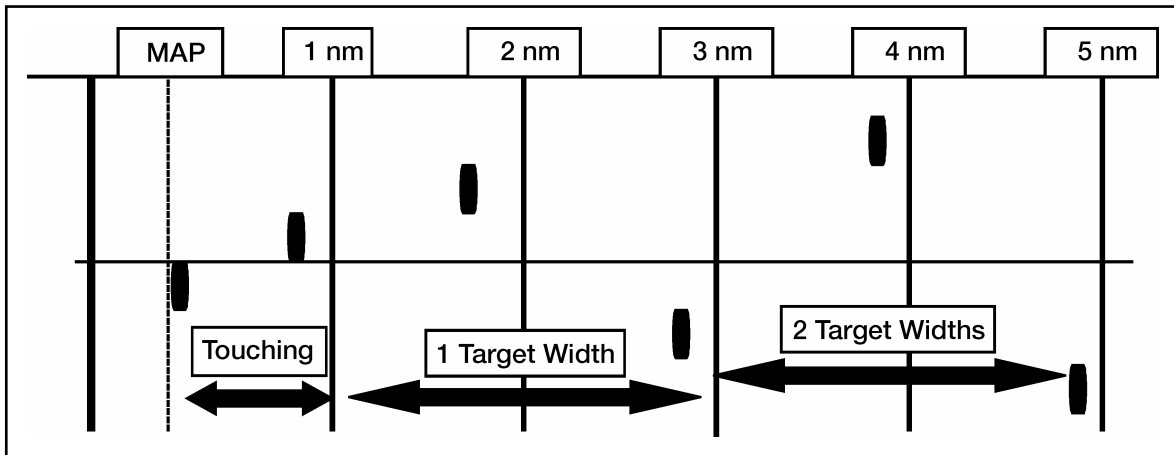

Figure 3-4. Radar Safety Limits (ASR with Analog Video)

3-24. If the pilot deviates from the final approach course beyond the limits in the previous paragraph, or the pilot does not respond to trend information, apply the procedures outlined in FAAO 7110.65.

FLIGHT INSPECTION APPROACHES

3-25. When conducting radar approaches for flight inspection (FI), the pilot will perform a minimum of two approaches to check facility alignment.

3-26. One approach will be conducted under normal conditions requiring numerous glide-path information calls. This approach establishes the facility angle and course alignment. The FI pilot commonly refers to the elevation cursor as the “A” cursor (see figure 3-5).

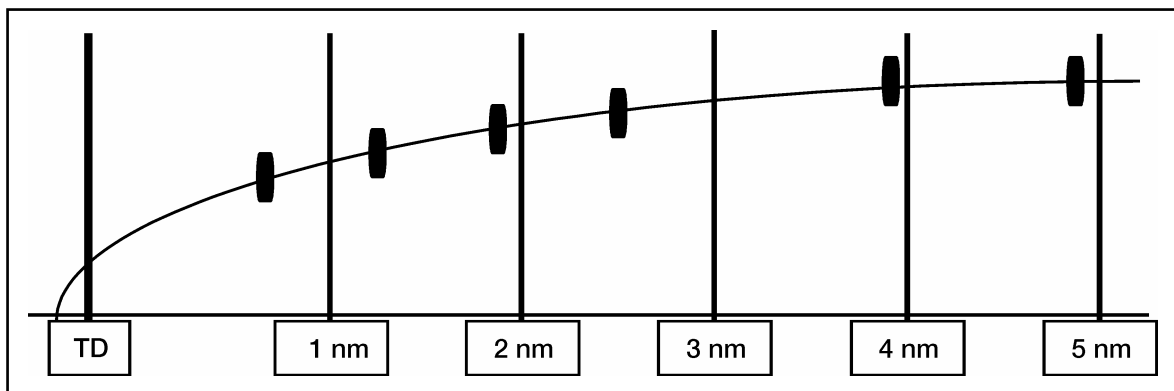

Figure 3-5. PAR “A” Cursor (on Glide Path)

3-27. The second approach will be to check the glide-path angle lower safe limits (see figures 3-6 and 3-7). The FI pilot will request that the controller use the “B” cursor for the approach (see figure 3-6). Older analog radar systems such as the FPN 40/62, TPN-18/18A do not display a “B” cursor. To execute the lower safe limit approach, use the “A” cursor to apply the following procedures using standard phraseology (see figure 3-7).

- Issue descent notification 10 to 30 seconds prior to the top of the aircraft target touching or an eighth of the target width intercepting the elevation cursor. The aircraft’s final approach fix or descent point will have to be adjusted to compensate for this type of approach.
- When the top of the aircraft target touches the elevation cursor, the aircraft will be considered on-path for the lower safe limits approach using the “A” cursor (see figure 3-7). Approaches using the “B” cursor are identical to normal PAR glidepath except for the use of the “B” cursor and the phraseology “on-path” (see figure 3-6).
- Issue standard course and trend information to maintain the aircraft on glide path throughout the approach, as described previously.

3-28. FI approaches are normally conducted by the most experienced controller in a facility. This does not preclude familiarizing all controllers with FI procedures, terminology, and maneuvers. These procedures are further outlined in FAAO 8200.1A and shall be incorporated in the facility training program.

Note: In accordance with FAAO 8200.1, surveillance approaches shall be evaluated using surveillance type radarscopes. Conducting an ASR approach on a PAR display is not acceptable for flight inspection purposes. This does not preclude controllers from exercising the elevation failure procedures of FAAO 7110.65.

3-29. All radar facility controllers shall receive this training and it will be annotated in the individual training records as “Radar Safety Limits.”

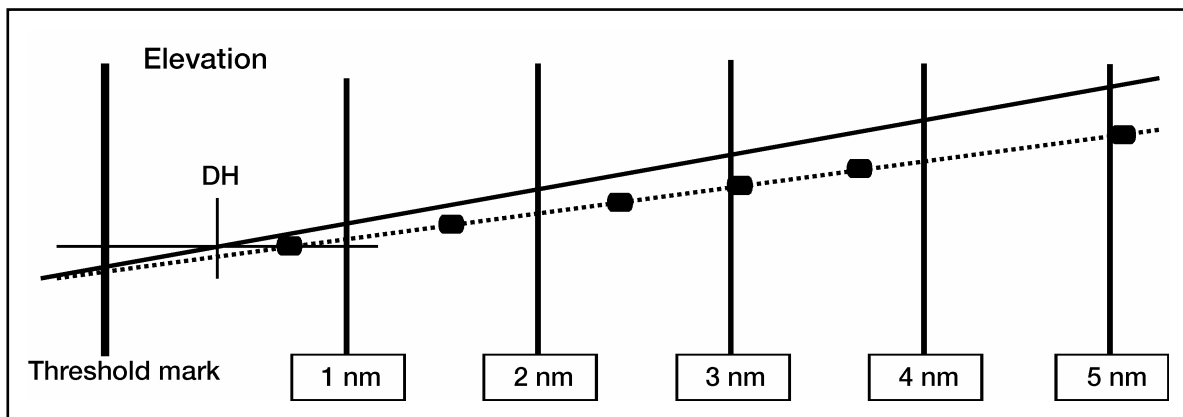

Figure 3-6. “B” Cursor Lower Safe Limits (on Path)

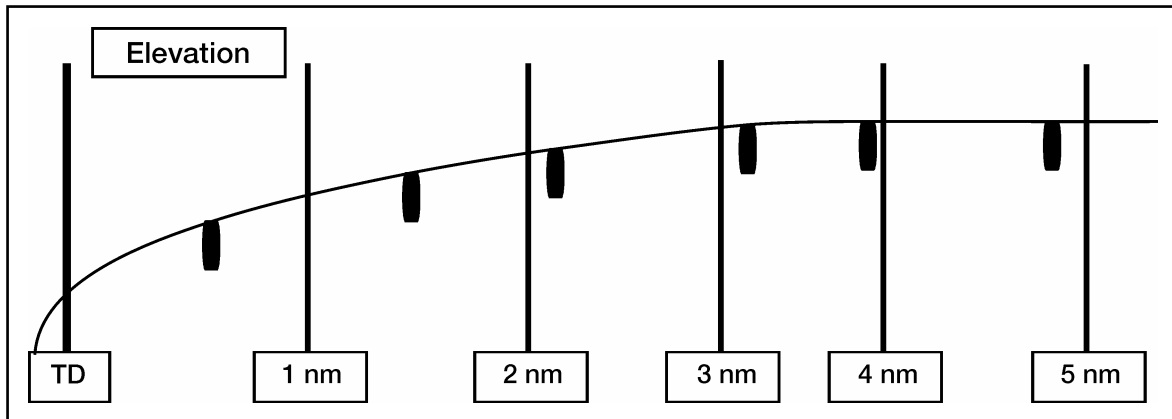

Figure 3-7. “A” Cursor Lower Safe Limits (on Path)

3-30. Flight inspection of deployed radar facilities is determined by the mission requirements. See appendix G for installation and NAVAID certification requirements/guidance.

MINIMUM VECTORING ALTITUDE CHARTS

3-31. To provide controllers with minimum IFR altitudes for radar vectoring, facilities shall prepare MVA charts for all ASR systems. The area covered by the MVA chart shall be to the maximum primary radar range (installation) and a minimum of 25 nautical miles (NM) (tactical). (Appendix G has more information for tactical operations.) MVA values from adjacent IFR facilities may be utilized outside a facility delegated airspace/operations area. Facility chiefs shall determine where the MVA charts are to be displayed, and the appropriate DARR should be contacted, if assistance is required. Figure 3-8 is a sample of an MVA chart, page 3-12.

3-32. The MVA chart will be drawn on two current sectional aeronautical charts. The most current obstruction data for updating an aeronautical chart prior to use is available at the National Imagery and Mapping Agency (NIMA) Electronic Chart Updating Manual (ECHUM) site (<http://164.214.2.62/products/webchum/index.cfm>). Carbon or other suitable duplication methods may be used if the information can be reproduced clearly. The chart will be centered on the location of the radar antenna site and segmented into areas, as required by the different MVAs. Configuration of the areas and features shown on the chart will vary with local terrain and operational considerations. If the following methods apply, whoever prepares the chart shall—

- Depict areas in relationship to magnetic bearings from the antenna site and radials from very high frequency omnidirectional ranges (VOR), very high frequency omnidirectional ranges and tactical air navigation (VORTAC), tactical air navigation (TACAN), nondirectional radio beacons (NDB), or radar display range marks.
- Make area boundaries compatible with map overlay or video map data to facilitate correlation between vectoring charts and radar displays.

- Make each area large enough to accommodate aircraft vectoring. In some cases, it may be desirable to combine adjoining smaller areas having different altitudes into a single large area with one altitude.
- Establish area boundaries at least 3 miles from the obstruction that determines the MVA. If the distance from the antenna is 40 miles or more, the area boundaries will be at least 5 miles from the obstruction.
- Enclose an isolated prominent obstruction with a buffer of at least 3 miles to avoid a large area with an excessively high MVA. If the distance from the antenna is 40 miles or more, the obstruction will be enclosed with a buffer of at least 5 miles. This facilitates vectoring around the obstruction.

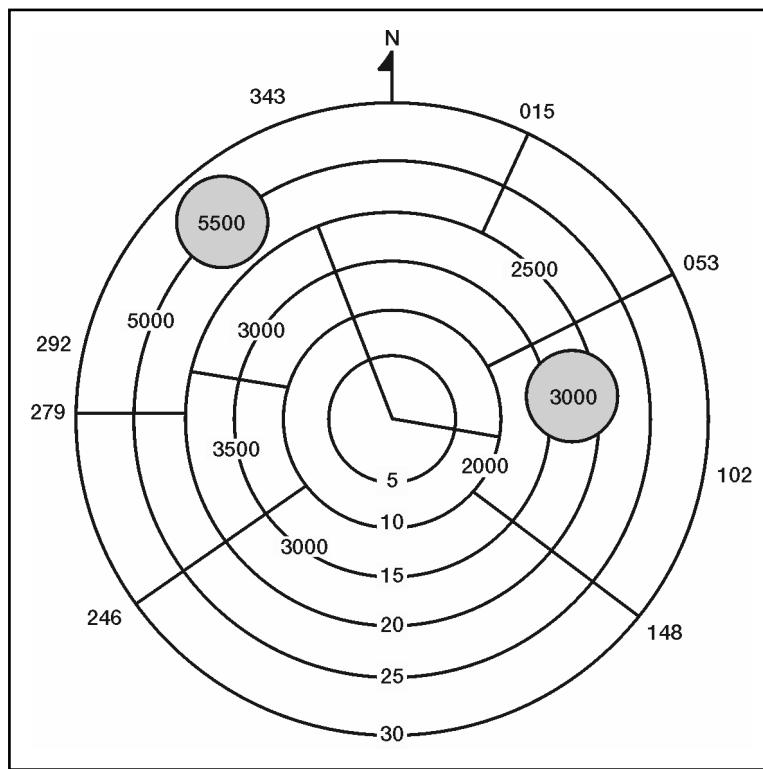

Figure 3-8. Sample MVA Chart

3-33. The minimum IFR vectoring altitude in each area also shall be determined. Minimum vectoring altitudes are established despite the flight-checked radar coverage in the sector concerned. Altitudes are based on obstruction (manmade or terrain) clearance criteria only, and the controller must determine if a target return is adequate for control purposes.

3-34. An MVA may be established outside of controlled airspace. If an MVA is established, this information will be noted on the chart. The minimum-vectoring altitude on MVA charts must be compatible with vectoring altitudes established for associated radar instrument approach procedures. The minimum vectoring altitude in each area will be shown, and the controlling obstructions will be documented.

3-35. The name of the facility will be affixed to both sectional charts, and the edition and date will be printed on the obstruction documentation of each MVA chart. MVA charts will be submitted to the appropriate DARR for review, prior to submission for FAA approval. The DARR will then return one set of charts to the originating facility. MVA documentation will be submitted to the DARR using FAA Form 7210-9 (*En Route Minimum IFR/Minimum Vectoring Altitude*):

- Have the FAA Form 7210-9 signed by the ATC chief/ATC SR SGT/PSG.
- Provide two copies of the new current FAA Form 7210-9 and maps.
- Do not use large pens to mark on the charts or labels taped/glued; this can cover-up obstacles.
- Use the FAA 7210.3, chapter 3, other displays and FAA Order 8260.19, chapter 3, section 7, to prepare the form and document information on charts. Also, see the back of FAA Form 7210-9 for additional instructions.

3-36. The ATC chief/ATC SR SGT/PSG/ATC facility chief shall ensure that MVA charts are reviewed and the necessary changes made at least once annually to maintain currency and simplicity. They shall obtain FAA approval through the appropriate DARR for all reviews and revisions.

MINIMUM SAFE ALTITUDE WARNING AND CONFLICT ALERT

3-37. Minimum safe altitude warning (MSAW) is a software function of the ARTS designed to generate an alert when an associated aircraft with Mode-C is at, or predicted to be at, an unsafe altitude. MSAW monitors aircraft for terrain and obstacle separation and will generate an alert, both aural and visual, on the display of the air traffic controller. MSAW consists of two detection components, the general terrain map (GTM) and the approach path monitor (APM). The ATC chief/ATC SR SGT/PSG/ATC facility chief may temporarily inhibit the MSAW, the approach path monitor portion of the MSAW, and conflict alert (CA) functions if their continual use would impact adversely on operational priorities. He is authorized to inhibit CA at specific operating positions, if advantageous to operations.

3-38. MSAW digital terrain maps shall be kept current. The DARR shall ensure that FAA regional airspace branches furnish all automated radar facilities copies of newly received FAA Forms 7460-2 (*Notice of Actual Construction or Alteration*). The DARR also shall ensure that all automated radar facilities receive emergency notices of the erection of structures that are 200 feet or more above ground level and lie within 60 nautical miles of the radar site. To keep digital terrain maps (DTM) current, automated radar facilities also require copies of the National Flight Data Digest (NFDD) that contain information pertinent to that facility.

3-39. The ATC chief/ATC SR SGT/PSG/ATC facility chief shall ensure that FAA Forms 7460-2 are reviewed and the appropriate corrections made to the DTMs. He also shall ensure that the magnetic variation of the facility DTMs coincides with the magnetic variation of the facility radar video and geographical maps.

3-40. A DTM is constructed to align with the radar antenna, which has been offset for magnetic north. Therefore, any change in antenna offset will result

in a corresponding change in the relative positions of the terrain points and obstacles used to determine DTM bin-altitude assignments. This will require, not only generating and verifying a new DTM, but also readapting the MSAW and CA databases to coincide with the changed declination. These databases would be, for example, airport areas, inhibit volume areas, and capture boxes.

MAGNETIC VARIATIONS OF VIDEO, GEOGRAPHICAL, AND MSAW DIGITAL TERRAIN MAPS

3-41. Permanent echoes are the primary references for verifying radar antenna alignment. The ATC chief/ATC SR SGT/PSG/ATC facility chief shall ensure that the magnetic variations of radar video, geographical, and DTMs coincide.

DIGITAL MAP VERIFICATION

3-42. The accuracy of new or modified digital maps shall be verified by using targets of opportunity that fly over displayed fixes, navigational aids, and so forth. Discrepancies shall be documented showing the observed direction and displacement. If any discrepancy cannot be corrected or, if the results obtained from targets of opportunity are not satisfactory, the facility may request a flight check through the DARR.

RADAR BEACONS

3-43. Radar beacon (IFF or selective identification feature [SIF]) decoders permit controllers to display responses from selected transponder reply codes in modes 1, 2, and 3. SIF mode 1 and 2 replies are defined by appropriate command instructions. Controllers shall not instruct an aviator to change to, or turn off, these modes without specific approval from a responsible authority.

3-44. When existing beacon equipment does not display emergency returns without specific actions by the controller, he shall not be required to monitor radar indicators for emergency display possibilities except—

- When advised by an aircraft that an emergency condition exists and that the airborne equipment is set to provide emergency returns.
- To support emergency situations at the request of an ATC facility or appropriate agency.

3-45. To obtain the desired display with currently installed equipment, controllers should—

- Select only the radar beacon codes necessary to display radar beacon replies associated with the controller area of jurisdiction.
- Select the raw/test position to display aircraft equipped with an IFF radar beacon decoder only.

Note: Replies from beacon-equipped aircraft will appear as undecoded pulse trains when the equipment is operated in this configuration.

3-46. The double-code train displayed by the ID feature is designed to appear on the indicator for 30 seconds after the pilot releases the switch on the airborne equipment. A controller shall not instruct a pilot to turn off this component of the airborne equipment.

3-47. When primary radar is not usable and beacon alignment has been verified, beacon returns may be used to vector the aircraft to a point with PAR coverage. This is where the final approach begins. Only primary radar will be used to conduct PAR approaches. Beacon returns shall not be used to conduct ASR final approaches unless an emergency exists and the pilot concurs with their use.

3-48. When it is desirable to do so, beacon targets may be displaced at a slightly greater range than their respective primary returns. A facility will issue a directive specifying the standard relationship between primary returns and the beacon control slash of secondary returns. This directive is issued whether or not a beacon adjustment is done. The maximum allowable displacement is one-half mile applied in one-quarter-mile increments.

SECTION II – FLIGHT FOLLOWING

3-49. The procedures in this chapter for flight following and airspace management are for use in and around cantonment areas, training areas, and ranges. However, this does not preclude their use in a tactical environment.

PURPOSE

3-50. Flight following is the observation of the progress of aircraft identified by radar or by reports at predetermined times or geographic points. The aviator provides the primary navigation information and the controller receives and correlates the aircraft identity with the appropriate geographic position. Flight following also is a service that may be used to provide pilot briefings and en route communications and to assist aircraft in emergency situations. In addition, it may be used to issue and relay ATC clearances and aviation weather information, monitor NAVAIDs, and provide a point-of-flight watch.

RESPONSIBILITIES

3-51. Installation commanders should review their local airspace management measures and determine if an Army airspace information center facility is required for flight safety in their cantonment areas, training areas, and ranges. When possible, the airspace management concept (A²C²) described in FM 3-52 should be incorporated at each installation system for airspace management. To preclude conflict, commanders may need to establish an A²C² cell to be responsible for developing procedures for planning and scheduling airspace use. Installations should take the following actions to evaluate existing methods of airspace management or to develop and implement additional airspace/aircraft procedures:

- Determine overall requirements for airspace management training based on the number of aircraft.

- Establish and coordinate an air route system with the installation plans and training office, Assistant Chief of Staff, G3 (Operations and Plans), (G3) air, AT&A officer, and other key players in the airspace management arena.
- Establish routes to move aircraft to/from/through cantonment areas, training areas, or ranges.
- Ensure that routes of flight do not cross/join or have two-way traffic at the same altitude, or establish procedures to preclude conflict.
- Ensure the use of a common frequency for aircraft using the same routes of flight or training areas.
- Establish adequate reporting points that are easily identifiable and not located in or near brightly lighted or populated areas.
- Establish training areas, and subdivide free-play areas for mission training based on the overall training/airspace requirements, number of aircraft, and type of training.
- Number, letter, or name subdivided areas, and depict them on the installation maps.
- Schedule free-play training areas in advance for specific unit training.
- Establish control procedures that preclude conflict on ingress/egress routes where chokepoints may exist.
- Establish separate routes of flight for night vision device (NVD)/nap-of-the-earth (NOE) training and operations.
- Ensure that NVD/NOE routes have easily identifiable start and release points.
- Establish procedures to preclude the mixing of lighted and unlighted aircraft.
- Establish the maximum allowable density for aircraft in each free-play training area, and specify the data in the installation SOP.

3-52. Airspace information centers, with a staff of qualified ATC personnel, shall provide communication and control of corridor feeder-route systems, chokepoints, crossing corridors, and transition areas in cantonment areas, training areas, and ranges. When required, these facilities provide altitude or other means of separation. In addition, they shall—

- Provide a common frequency.
- Issue advisories that allow pilots to separate their aircraft from other aircraft and activities or adverse weather that may endanger the aircraft.
- Monitor the flight progress of all participating aircraft within the facility area of responsibility.
- Advise other area users of aircraft activity that may impact on, or conflict with, the mission or activity.
- Provide assistance during emergencies.
- Assist with search and rescue efforts, as needed.

PROCEDURES

3-53. The procedures developed for conducting day-to-day operation of an airspace information center depend on a number of circumstances. Local

requirements govern exact operational procedures. However, the number and types of operating agencies and the activities in the facility area influence these procedures. Installations needing assistance in determining requirements for facility personnel and equipment shall submit a facility request through their MACOM to ATSCOM. (See AR 95-2 for blank form and procedures.) The procedures and requirements outlined below establish a minimum standard and shall apply to all Army airspace information centers.

3-54. Each facility shall have an up-to-date map of its area of responsibility. Each map shall depict the following areas and routes:

- Explosive ordinance disposal (EOD)/hazardous cargo route.
- Impact areas.
- Firing points.
- Navigational aids.
- Air defense identification zones (ADIZ) and no-fly areas.
- Prominent obstructions.
- NOE, NVD, and remotely piloted vehicle (RPV) routes.
- Mandatory reporting points.
- Radio and radar blind spots.
- IFR recovery airfields and landing areas.
- Restricted/prohibited areas.
- Aircraft entry and exit points.
- Changeover points.
- Corridors, transition areas, training areas, and ranges.
- The same grid system as other area ATC and search and rescue facilities.

3-55. The flight progress of participating aircraft shall be monitored, and the maximum time between position reports shall be 30 minutes. Less time may be required depending on the type, length, and area of routes such as an NOE route.

3-56. The facility's area of responsibility shall be divided into as many subareas as necessary to simplify recognition and reporting. Each area shall be lettered, numbered, or named. The boundaries of these subareas, such as rivers, roads, and power lines, should be easily recognized from the air.

3-57. Procedures shall be developed to ensure the timely receipt and dissemination of area weather information. Each facility should be electronically connected to the same weather dissemination equipment as that in other area ATC facilities.

3-58. Procedures shall be developed between the flight following facility and other area ATC facilities to ensure that timely control information is passed. Letters of agreement and operations letters shall establish procedures concerning hand-offs, control transfers, flight plans, and arrival and departure times.

3-59. The facility should have the capability of communicating with other ATC facilities and agencies that use or operate within the facility area of responsibility. Standard ATC radio and interphone phraseology shall be used in all facility communications.

3-60. The facility area and airspace is determined by local, host-nation, post, camp, or station requirements. The area and airspace may or may not contain a restricted or prohibited area, overlap, underlay or join another ATC facility area or airspace. Whether a facility joins another ATC facility area or airspace is determined by local requirements, equipment, and agreements. FAAO 7400.2 and FAAO 7610.4 contain additional information on the procedures for handling airspace matters and special military operations.

Chapter 4 Facility Equipment

This chapter discusses the ATC facility equipment, equipment checks and facility maintenance. It includes information on facility ground inspection, certification, and recertification procedures and the radar/NAVAID emergency warning and evacuation system. (The equipment requirements for an Army ATC facility and information on the basic operating equipment and suggested equipment layouts for fixed facilities are found in chapter 8, section IV.)

CONTENTS

Equipment Layouts	4-1
Facility Ground Inspection, Certification, and Recertification Procedures	4-3
Radar/NAVAID Emergency Warning and Evacuation System (Installation Facilities Only)	4-5
Navigational Aids	4-11

EQUIPMENT LAYOUTS

4-1. The ATC chief/ATC SR SGT/PSG/ATC facility chief may recommend changes to the equipment layout of his facility. However, installation facilities must submit the request for approval of a change, modification, or alteration to ATC equipment, through command channels, to the Commander, USAAVNC, ATTN: ATZQ-ATC, Fort Rucker, Alabama 36362-5265. Tactical units must submit the request for approval of a change, modification, or alteration to ATC equipment, through command channels, to the Commander, Communications-Electronics Command (CECOM), AMSEL-LC-CCS-A-AT, Fort Monmouth, New Jersey 07703-5000.

EQUIPMENT CHECKS/CHECKLIST

4-2. The ATC chief/ATC SR SGT/PSG/ATC facility chief shall establish a list of equipment checks to be completed at the beginning of each shift; for example, FSC-92, radio, light gun, DBRITE, and automatic terminal information service (ATIS) checks. DA Form 3502-R shall be used to record the results of equipment checks. Tape recorders may be included in the equipment checklist. However, they also require additional checks, as shown in paragraph 4-41 (*Recorder Checks and Tape Changes*).

4-3. The equipment checklist shall be a locally produced form; the checklist may be a separate form, or it may be placed on the back of DA Form 3502-R. This form is not intended to circumvent the Army maintenance system, but only to serve as a list of equipment that must be checked. Completion of equipment preventive maintenance checks and services (PMCS) shall be documented on the appropriate maintenance form according to DA Pam 738-750 and applicable operator/maintenance manual. The equipment

checklist shall be completed at the beginning of each shift. Completed checklists shall be filed with and retained the same as DA Form 3502-R.

4-4. If all equipment is operational, the entry on the form may be limited to “checklist complete.” If outages occur, the entry must identify those outages, the name of the agency notified and their operating initials; for example, “checklist complete; DBRITE and 126.2R OTS MAINT/CB NTFYD.” Equipment outages shall be documented on the appropriate maintenance form according to DA Pam 738-750 and the applicable operator/maintenance manual.

4-5. If an operational check of the primary crash alarm system or emergency frequencies cannot be conducted when a facility begins operation, these systems shall not be included as items on the equipment checklist. These systems shall be checked at least once a day and the results entered on DA Form 3502-R. (Chapter 8 describes the additional equipment checks and requirements.)

4-6. On DA Form 3502-R, a capital “E” (equipment) shall be placed in the time (UTC) column to the left of entries showing equipment out-of-service time and return-to-service time. The “E” for a specific equipment outage need not be repeated each day thereafter unless the equipment returns to service. Examples of these entries are “E 0800, checklist complete, 126.2T OTS MAINT/CB NTFYD-JO” and “E 0810, 126.2T RTS, radio and recorder checks complete-JO.”

NOTICES TO AIRMEN

4-7. ATC facilities are responsible for notifying the designated facility or office of any equipment outage, service curtailment, or airfield activity that may require a NOTAM. These procedures shall be contained in a LOA/operations letter.

FACILITY MAINTENANCE

Scheduling

4-8. The maintenance supervisor at each facility or unit shall ensure that personnel schedule services, inspections, and repairs of ATC equipment according to AR 750-1, DA Pam 738-750 and the applicable operator/maintenance manual. Personnel shall coordinate scheduling with the ATC CHIEF/ATC SR SGT/PSG/ATC facility chief.

Coordination

4-9. The maintenance chief and ATC chief/ATC SR SGT/PSG/ATC facility chief shall ensure that certified maintenance personnel are available to perform any phase of the cursor alignment or adjustment requiring the use of test, measurement, and diagnostic equipment (TMDE). Maintenance of a NAVAID that services two or more airfields or is a part of the National Airspace System (NAS) must be coordinated with the ARTCC and other facilities affected.

Training/Use of Manuals

4-10. The ATC chief/ATC SR SGT/PSG/ATC facility chief shall ensure every controller is trained to perform operator-level and crew-level unit maintenance on each equipment system or subsystem. Controllers shall use

the appropriate technical or commercial manuals to perform this maintenance.

Certification of Technicians

4-11. Maintenance supervisors at each facility or unit shall ensure that newly assigned maintenance personnel are certified as ATC maintenance technicians. The technicians must be certified according to the maintenance certification program, which is explained in chapter 8.

Note: Until the AN/FSC-92(V) console is replaced, facilities using this console shall develop/ implement a program to train ATC operators to reboot the system. This procedure shall be incorporated into the facility training program and annotated on the controllers' DA Form 3479-R.

Spare and Repair Parts

4-12. Maintenance personnel shall obtain spare and repair parts to support the following installation systems from Commander, U.S. Army Aviation Center, ATTN: ATZQ-ATC, Fort Rucker, Alabama 36362-5265, as outlined in the current external standing operating procedures:

- AN/FPN-40 radar.
- AN/FRN-41 VOR.
- AN/GRC-171/211 transceivers.
- GRR/GRT receivers/transmitters.
- GRM TTC-8/800.
- AN/FRN-47 distance measuring equipment (DME).

FACILITY GROUND INSPECTION, CERTIFICATION, AND RECERTIFICATION PROCEDURES

GROUND INSPECTION

4-13. A facility ground inspection shall be conducted to determine if the facility is operating within, and can be expected to continue operating within, performance tolerances. The inspection shall consist of collecting and recording performance data, inspecting the physical condition of the facility, and reviewing the quality of maintenance procedures. (See chapter 8.)

CERTIFICATION

4-14. When a facility is initially commissioned for use in the National Airspace System, the maintenance chief shall complete a formal certificate for facility certification. The chief will forward the certificate (figure 4-1) to the appropriate FAA office.

RECERTIFICATION

4-15. Facility recertification is conducted the same as initial certification except that the maintenance chief does not need to send a formal certificate to the FAA. Recertification shall be accomplished at the intervals specified in TM 95-225.

ATC FACILITY CERTIFICATION

The undersigned hereby attests that (name of ATC facility) meets the applicable performance standards and tolerances in the pertinent technical manuals. Should this facility subsequently fail to meet applicable ground or flight inspection criteria, the maintenance chief agrees to issue a NOTAM through (name of FAA facility). In the latter event and if conflict with other IFR traffic could result, it is understood that continued use of the facility for military IFR operations will be disapproved by the FAA.

Signature _____

Name _____

Title _____

Date _____

Figure 4-1. Certificate for Initial Facility Certification

AUTOMATIC TERMINAL INFORMATION SERVICE (INSTALLATION FACILITIES ONLY)

4-16. ATIS provides advance operational and meteorological information for terminal areas and noncontrol airports using a controller-prepared tape recording. This information is repetitively broadcast on a voice outlet for aircraft arriving or departing an airport or operating within the terminal area. FAAOs 7110.65 and 7210.3 contain further guidance on ATIS.

CLOCKS

4-17. A reliable clock shall be visible from each operating position in all ATC facilities. Clocks shall be checked at the beginning of each shift. The results of time checks shall be logged on DA Form 3502-R. Time checks will be performed according to FAAO 7210.3. In a tactical environment, ATC facilities shall obtain a time check from the next higher control facility or from global positioning system (GPS).

LIGHT GUNS

4-18. ATC light gun color codes and meanings shall be attached to the back or side of the light guns. Except when they are in actual use, ATC light guns shall be adjusted to provide a red light when the switch is activated.

CRASH ALARM SYSTEM

4-19. Crash telephone and radio receiver/transmitter keys should be centrally located so they are readily available to all control positions. AR 385-95 and AR 420-90 prescribes the policies, procedures, and guidelines on the primary crash alarm system, secondary crash alarm circuit, and local crash grid maps.

4-20. The ATC chief/ATC SR SGT/PSG/ATC facility chief shall develop procedures for each position in the event of an aircraft accident/incident. These procedures shall be published in the facility FTM and separate position binders.

RADAR/NAVAID EMERGENCY WARNING AND EVACUATION SYSTEM (INSTALLATION FACILITIES ONLY)

4-21. Radar/NAVAID facilities close to runways shall be equipped with an emergency warning and evacuation system to alert personnel working around or in these facilities to emergency situations. This system should consist of an aural or a visual alarm or a combination of the two. One or more of the ATC facilities shall be able to activate the alarm at all times. The ATC chief/ATC SR SGT and maintenance chief shall develop and publish evacuation procedures.

DIGITAL BRIGHT RADAR INDICATOR TOWER EQUIPMENT (INSTALLATION FACILITIES ONLY)

4-22. Some towers are combined with full radar approach control facilities, and the controllers rotate between the tower and approach control. Under these conditions, local controllers may use certified DBRITE displays for the terminal radar function if they can satisfy the FAA air traffic requirements regarding aircraft operating on runways or in the surface area. The conditions and limitations for DBRITE usage shall be specified in an LOA.

4-23. Other towers are combined with full radar approach control facilities; however, the controllers do not rotate between the approach control and the tower. Under these conditions, local controllers may use certified DBRITE displays to—

- Identify aircraft and their exact location or spatial relationship to other aircraft. (This authority does not alter the visual separation procedures outlined in FAAO 7110.65.)
- Provide radar traffic advisories to aircraft.
- Provide directions or suggested headings to VFR aircraft as a radar identification method or as an advisory navigational aid.
- Provide information and instructions to aircraft operating in the surface area.

4-24. When the conditions in the previous paragraph and the following conditions are present, local controllers may also use certified DBRITE displays to ensure separation between successive departures, arrivals, and overflights within the surface area. The additional conditions are if—

- Tower has no delegated airspace.
- Radar separation procedures do not require the tower to provide radar vectors.
- Local controllers have radar training and certification or qualification commensurate with their radar duties.
- A signed copy of the LOA was submitted to the DARR.

Note: The LOA must authorize the specific function and prescribe the procedures to be used. It must also prescribe the process for a transition to nonradar procedures or the suspension of separation authority in case of a radar outage.

4-25. The procedures for giving and receiving radar handoffs or pointouts do not impair the local controller's ability to satisfy FAA and Army ATC requirements for aircraft operation on runways or within the surface area.

4-26. The tower facility may be delegated the responsibility for providing the services outlined in the previous paragraphs. In flight-following facilities, DBRITE will provide traffic advisories and VFR radar services.

4-27. The DBRITE is IFR-certifiable; at select GCA locations, it will serve as the surveillance radar.

TELEPHONE LINES

4-28. When possible, all noncommercial telephone lines to installation ATC facilities shall terminate in the communications console key system installed in the facility. Commercial telephones should be provided on separate instruments. When this is not possible and commercial telephones are recorded, a beeper tone is required.

4-29. Direct telephone lines are required between ATC facilities. Their use shall be restricted to the relay of essential command and control instructions and advisories. Calls on direct telephone lines are handled secondarily to the primary function of ATC services. The lines should not be used to relay information such as departure or arrival times and load messages that can be handled by other means. If either a command post or an ATC facility requires immediate priority over the other, it shall on initial contact state, "Stand by for emergency instructions." These occurrences shall be entered on DA Form 3502-R.

4-30. Direct telephone lines are required between adjacent ATC facilities and area ATC centers. Such elements as the fire station, crash and rescue team, flight operations, weather station, military police, and hospital are also authorized direct telephone lines.

RADIO EQUIPMENT

4-31. ATC facilities are required radio transmitters and receivers according to chapter 8. ATC facilities are also authorized to join radio nets with the crash and rescue team, airfield services, weather station, fire station, ambulance service, and security agency. To the extent possible, these radios will terminate within the communications console.

4-32. During the hours of operation, ATC facilities shall continuously monitor all assigned radio frequencies. Facilities that share radios shall establish procedures to ensure that one of the facilities continuously monitors these frequencies.

4-33. All ATC facilities should have a transmit-receive capability on emergency frequencies 121.5 megahertz (MHz) and 243.0 MHz. When ATC facilities are close, they shall share transmitters and receivers if services will not be degraded. If transmitters and receivers are shared, geographical area coverage shall not be reduced. In addition, transmitters will be equipped with lockout devices to avoid inadvertent interference between facilities.

4-34. The two emergency frequencies shall not be terminated on the same transmit-receive key selector of any other frequency. When a remote communications console is provided to a non-ATC facility at an airfield that

has an ATC facility, only the emergency receiver shall be provided. ATC facilities without an emergency frequency capability shall have appropriate telephone lines for relaying emergency information.

4-35. As a minimum, two-way transmitter and receiver checks shall be conducted daily on all radio frequencies. These checks shall also be conducted following tape recorder and other equipment repairs and normal preventive maintenance.

SEARCH AND RESCUE SATELLITE-AIDED TRACKING (SARSAT)

4-36. The search and rescue satellite is a system of international satellites used for monitoring emergency frequencies 121.5 MHz, 243.0 MHz and 406 MHz. Any transmission over 30 seconds long on these frequencies (instantaneously on 406 MHz) causes an international search and rescue satellite to activate the SARSAT ground-processing center. This puts rescue operations into action. Unintentional keying of these frequencies has caused a number of false alarms. Maintenance checks of these frequencies shall be keyed into dummy loads. The operational checks shall not exceed 15 seconds.

RECORDERS

4-37. Installation ATC facilities shall have recorders and shall record all ATC communications by position. All tactical facilities and/or systems equipped with recorders shall adhere to these procedures. In addition, the facilities may share recorders, when feasible (tower/GCA, ARAC/flight following).

Note: The digital voice recorder system (DVRS) has an internal global positioning system time source. It is not necessary to reserve a separate recording channel for "time."

Position-Recording Channels

4-38. Except as shown in the following paragraph 4-39 (*Radio transmit-receive frequencies*), the facility shall record relative to position rather than frequency. Recording channels shall be assigned to positions in the following order:

- Precision approach radar.
- Arrival control.
- Approach control.
- Departure control.
- Local control.
- Flight data (tower).
- Flight-following control.
- Clearance delivery.
- Ground control.
- Flight data (radar).
- Flight-following data.
- Coordinator.
- Supervisor.
- Automatic terminal information service.

Note: When a channel is not available to record on the ATIS, the message will be recorded once at an operating position.

Radio Transmit-Receive Frequencies

4-39. After requirements in the previous paragraph are met, the remaining spare channels may be used for channel clearing and for recording the primary radio transmit-receive frequencies. The frequencies are recorded in the following order:

- Very high frequency (VHF) and ultra high frequency (UHF) emergency.
- Primary crash net.
- Approach control (radar or nonradar).
- Departure control.
- Local control.
- Ground control.
- Pilot to metro service.

Newly Established Positions

4-40. A facility may implement additional operating positions. If additional operating positions are implemented, recorder channels assigned to functions in the previous paragraph shall be released in reverse priority to record these new positions. The desirability of recording individual frequencies shall not justify acquiring additional recorders to record by frequency. Instead, unused recorder channels should be assigned to the applicable functions. When a facility is equipped with more than one recorder, the ATC chief/ATC SR SGT/PSG/ATC facility chief shall determine which one to use in recording the previously (*Radio transmit-receive frequencies*) listed frequencies, positions, and services. The ATC chief/ATC SR SGT/PSG/ATC facility chief also determines the priority in which they are recorded or released.

Recorder Checks and Tape Changes

4-41. The ATC chief/ATC SR SGT/PSG/ATC facility chief shall determine if their local situation would be better suited for a daily, twice weekly, or weekly changing of the *recorded media*. At a minimum, the *recorded media* will be changed weekly.

4-42. A facility memorandum, operations letter, or letter of agreement shall be developed outlining the procedures for changing, marking, loading, and securing recorded media, and for controller/maintenance responsibilities. If the DVRS is not convenient to operating areas, the ATC chief/ATC SR SGT/PSG/ATC facility chief and the responsible maintenance chief shall develop a written agreement assigning this responsibility. It is imperative that all controllers and maintenance personnel are properly trained to check the recorders, change the recorded media, and perform PMCS. This training will be noted in the training records.

- The controllers monitor the quality of recordings. At the beginning of each shift, the SL or CIC shall ensure that all recording channels are operating properly.

- The ATC chief/ATC SR SGT/PSG/ATC facility chief and the maintenance chief shall establish written procedures to ensure that the recording quality is checked after all radio, recorder, or telephone equipment maintenance. These checks shall be noted on DA Form 3502-R. At dual facilities, the ATC chief/PSG may appoint one facility to make all tape changes and recorder checks. However, the results of tape changes and recorder checks shall be noted on DA Form 3502-R for each facility.

Tape Recorder Labels

4-43. An ID number shall be assigned/attached to each recorded media. At the beginning of each day, the number of the recorded media will be entered on DA Form 3502-R. If it is necessary to change the recorded media during the shift, the reason for the change, the number of the recorded media removed, and the number of the recorded media started shall be entered on DA Form 3502-R. The individual changing the *recorded media* shall annotate the date/time/initials on the recorded media log before storing the cartridge.

Tape Recording Accountability

4-44. The ATC chief/ATC SR SGT/PSG/ATC facility chief has custodial responsibility for tape recordings made on equipment furnished or maintained by the Army. When another service or agency has custodial responsibility for the recorder tapes, an LOA shall be initiated to specify access and retention policies and procedures.

Tape Recording Maintenance

4-45. The *recorded media* containing normal day-to-day operations shall be retained for a minimum of 15 days from day of last recorded material. The recorded media can then be erased, but only by using the procedures outlined in the DVRS operator's manual.

4-46. Recorded media containing information on emergencies, or alleged violations, shall be retained for 30 days. If the facility has a DVRS reproducer, or if an alternate means is available, the recorded media can be transferred to a regular cassette and will be retained for 30 days. Tapes shall be identified and certified as outlined in figure 4-2. At the end of 30 days, if no verbal or written request for these recordings has been received, they can be erased and reused as necessary. However, if a request is received within 30 days, the recordings shall be handled the same as a recording concerning an accident.

4-47. Recordings containing accident information shall be retained for a minimum of six months. They shall be extracted from the DVRS as soon as possible and identified and certified as outlined in figure 4-2. If recordings are not requested within six months, the tapes can be erased and reused as necessary. An exception to this policy is that all recordings pertaining to a hijacking will be retained for three years.

4-48. Recorded tapes are sometimes made part of an accident or incident investigation file. The only parts of recordings that must be retained are those that contain conversation during the time of the accident or incident and the initial and terminal overrun of five minutes of the running time of the accident/incident. Procedures for retaining this time period are outlined

in the DVRS operator's manual. It will provide for a direct electronic connection between the recording medium (the DVRS hard disk) and the target recorded media.

<p>I certify that this is the original recording made in _____ (facility) _____ containing all conversation on _____ (position) _____ at _____ (channel) _____ pertaining to _____ (accident or emergency) _____ (aircraft ID) on _____ (date) _____.</p> <p>Signature _____</p> <p>Name _____</p> <p>Grade _____</p> <p>Title _____</p> <p>Date _____</p>
--

Figure 4-2. Certification of Tapes Containing Accident Data

4-49. When re-recorded tapes/transcripts are certified, they become official records and shall be retained according to AR 25-400-2 and this manual. The re-recordings are treated the same as original tapes or records. If written authorization is received from the airfield commander or investigating team, re-recorded or transcribed tapes may be returned to service immediately. If written authorization is not received, the tape will be retained for six months.

Transcript Preparation

4-50. Each transcript will be prepared according to appendix E; each transcript will include the following information:

- Subject.
- Identity of the recording facility.
- List of facilities making transmissions and, as used in the body of the transcript, abbreviations for each.
- Frequency, landline, or position recorded.
- Date and time covered by the transcript.
- Certification.

Marking Completed Transcripts

4-51. The completed transcript will be marked "FOR OFFICIAL USE ONLY (SPECIAL HANDLING REQUIRED)." AR 25-55 contains more information on releasing records from Army files.

Abbreviations for ATC Facilities

4-52. ATC facilities included in the transcription shall be abbreviated by using the appropriate location designator followed by ARTCC, tower (TWR), ARAC, GCA, corps airspace information center (C-AIC), division airspace information center (D-AIC), or AIC. Aircraft may be identified by an abbreviated call sign when confusion will not result.

Format for Typed Transcription

4-53. A typed transcription will have the following format:

- Precede each transcription with the identity of the transmitting station. When the station is unknown, use UNK.
- Single-space the body of the transcription.
- Double-space between contacts to separate them.
- Show breaks in continuity of contact, such as garble, by using a series of asterisks; otherwise, the transcription shall be verbatim.
- Make time entries to the nearest second preceding each transmission when time-code generator systems are installed. These entries will be at approximately one-minute intervals in the body of the transcript.
- Certify the transcription as shown in figure 4-3.

As custodian of the original recording, I hereby certify this to be a true and exact (copy/transcript) thereof.

Signature _____

Name _____

Grade _____

Title _____

Date _____

Figure 4-3. Certification of Transcription

4-54. When copies of written records are required, certify each copy as shown in figure 4-4.

I hereby certify this to be a true and exact copy of the original record on file at this office.

Signature _____

Name _____

Grade _____

Title _____

Date _____

Figure 4-4. Certification of Copies of Written Records

NAVIGATIONAL AIDS

4-55. All NAVAIDs must pass an FAA flight check inspection before IFR operations are conducted. The procedures contained in TM 95-226 shall be used to construct a precision or non-precision approach that will service the

terminal area. The en route criteria shall be established by the ACA. Critical information about tactical approach procedures at instrumented heliports and airfields must be developed by the sector responsible for the approach. This information must then be disseminated to the aviation units, C-AIC/D-AIC, and the appropriate A²C² elements for inclusion in the airspace control order (ACO). The Tactical Approach Publications System (TAPS) form is the primary method of accomplishing this. The following actions shall be accomplished to prepare for a flight check:

- Ensure that all personnel are familiar with TM 95-225.
- Provide accurate facility data for new or relocated facilities.
- (Tactical only) Ensure a TERPS/TAPS package is complete and provide the approved packet to flight-check personnel.
- Develop an LOA concerning the airspace used for the approach procedure.
- Assign the best-qualified controller available.
- Establish communications on a single dedicated frequency.
- Ensure that all facility equipment is calibrated in accordance with applicable manuals.
- Ensure personnel will be available to make corrections and adjustments.
- Provide transportation to move flight inspection equipment and personnel.

4-56. The approach control facility normally is designated the primary NAVAID monitoring facility. At locations without an approach control, the tower is designated the primary NAVAID monitoring facility.

- Monitors.
 - Some ATC facilities do not operate continuously. If the NAVAID is to remain on the air continuously, another facility or agency shall be assigned monitoring responsibility. This facility or agency shall also provide continuous manning and respond quickly to the call for maintenance personnel. In addition, it shall establish procedures in a LOA or operations letter concerning equipment outages and submission of notices to airmen.
 - Monitors that do not provide an automatic visual or aural alarm shall be checked at least once an hour. When an ATC facility is responsible for monitoring NAVAIDs, the facility chief shall include monitoring instructions in the FTM. If a NAVAID monitor alarm is received, the ID feature shall be checked aurally and the responsible maintenance authority notified immediately. If the alarm cannot be silenced and the ID feature cannot be heard, the NAVAID is considered inoperative.
 - If personnel suspect that a control line or monitor failure rather than a malfunction of the NAVAID causes an alarm, they must take the appropriate action per FAO 7110.65. If a malfunction is confirmed, use of the NAVAID shall be discontinued. A NOTAM shall be published showing NAVAIDs with inoperative monitors as unmonitored. A Department of Defense (DOD) FLIP, en route supplement, and IFR supplement will also show those NAVAIDs without installed monitors as unmonitored.

- Interruptions and malfunctions.
 - The ATC chief/ATC SR SGT/PSG/ATC facility chief establishes procedures for reporting interruptions to NAVAIDs and malfunctions in communications and radar equipment. He ensures the timely response of maintenance personnel to a report of an interruption or a malfunction.
 - The on-duty SL or CIC shall report any known or reported malfunction in equipment or interruption to a NAVAID to the appropriate office; for example, maintenance personnel, ARTCC, approach control facility, and any other facility that may be affected. He then reports the malfunction or interruption to the airfield commander.

WIND INDICATOR EQUIPMENT

4-57. Normally, each AAF or Army heliport (AHP) has only one wind-sensing unit and all ATC facilities use the same unit. These wind indicators should be located at the landing and takeoff area. Because of terrain, distance, local operational requirements, equipment and facility upgrades, and mobile facilities, wind equipment may be located at various sites on the airfield. Readout values derived from transmitters not located at the landing and takeoff area shall be used as an aid to determine estimated wind conditions. Controllers can determine estimated wind after comparing readout values from transmitters and windsocks and from visual observations of the landing and takeoff area. Estimated wind values transmitted to other facilities and to pilots shall be reported as wind estimated (for example, “WIND ESTIMATED TWO ONE ZERO AT FIVE”).

ALTIMETERS

Setting Comparisons

4-58. At the beginning of each shift, an ATC facility providing air traffic service shall compare the official altimeter setting with its instrument setting. Any difference shall be posted next to the face of the instrument and recorded on DA Form 3502-R. The correction factor shall be applied to the reading obtained from the facility instrument before the altimeter setting is transmitted to a pilot or another facility. Use of the facility instrument shall be discontinued at—

- Non-precision approach locations when the correction factor exceeds ± 0.05 -inch of mercury.
- Precision approach locations when the correction factor exceeds ± 0.02 -inch of mercury.

Obtaining Official Altimeter Settings

4-59. Altimeter-setting indicators inspected and calibrated according to AWS guidance may be used to obtain the official altimeter setting at locations that have no local weather service support. At facilities with no weather reporting station and only one altimeter device, the altimeter setting may be compared with values obtained from adjacent weather stations if at locations where—

- Precision ILS or PAR approaches are conducted, the distance to the weather station is not more than 10 nautical miles and the wind speed is 25 knots or less.

- Non-precision approaches are conducted, the distance to the weather station is not more than 25 nautical miles and the wind speed is 30 knots or less.

Altimeter Settings Not Compared

4-60. When weather conditions indicate the probability of a steep pressure gradient between the two locations or the elevation difference exceeds 1,000 feet, altimeter settings are not compared. At locations that do not meet the 10- and 25-nautical mile limitations, a mercurial barometer or altimeter-setting indicator is required to make comparisons.

Tactical Altimeter-Setting Indicators

4-61. Tactical ATC facilities not equipped with calibrated altimeter-setting indicators shall obtain settings from supporting Air Force weather teams.

Estimated Settings

4-62. Air traffic controllers shall issue an altimeter setting as estimated according to FAAO 7110.65. They shall issue the setting as missing if it is not available.

EGRESS SYSTEMS (INSTALLATION FACILITIES ONLY)

4-63. All control towers shall comply with the egress requirements of the Life Safety Code in National Fire Safety Code 101. Local or host-nation safety and fire professionals shall evaluate compliance with the code. Documentation of evaluations shall be maintained as a permanent facility record. If host-nation requirements apply, they must be met even if they are more stringent.

4-64. Some towers must have an egress system besides the normal means of entering and exiting. These towers shall obtain and install a system that safety and fire professionals determine is satisfactory. The preferred alternate egress system is an exterior ladder that complies with the safety requirements for fixed ladders published in the American National Standards Institute Regulation A14.3.

NIGHT VISION DEVICES

NVD Training

4-65. At locations where NVDs are required, controllers shall be trained in the operational use of NVDs. Until NVDs are available to table(s) of distribution and allowances (TDA)/table of organization and equipment (TOE) ATC personnel, they should be obtained through coordination with the aviation unit requiring the training. All NVD training shall be entered on DA Form 3479-R, section III. The NVDs shall not be worn by controllers but used as binoculars during night vision operations. ATC facilities or units using NVDs shall establish a training program that includes, as a minimum, the instruction given below.

NVD Operation and Care

4-66. Orientation and briefing on NVD operation and care consists of a class on the characteristics, function, and maintenance of NVDs in accordance with the applicable technical manuals (TMs), to include the—

- Removal of NVDs from the receptacle, ensuring pressure is released.
- Removal of the front lens covers.

- Insertion of the battery.
- Adjustments of short gauge for flight data and adjustments of infinite for local and ground control.

Preparation of the Control Tower

4-67. This instruction includes—

- Use of minimum lighting.
- Covering the console to prevent reflection.
- Enforcing the no-smoking policy.
- Use of NVDs for no more than two hours without a break.
- Limit on the number of personnel in the tower.

Hands-On Training

4-68. This consists of an orientation after dark, to include—

- Instruction on distinguishing prominent terrain and other objects in the area.
- Unimpaired vision of traffic areas.
- Adjustment of devices, as required.
- Distinguishing an aircraft with minimum lighting.
- Difference between participating and nonparticipating aircraft.
- Strict observation of aircraft at all times.
- Control of airfield and landing area lighting.

Visual Contact Loss

4-69. To reestablish contact, the controller must—

- Know the altitude of the aircraft.
- Request aircraft position reports.
- Use known landmarks.
- Have the observation confirmed by another controller.

NVD Procedures

4-70. To establish local NVD procedures, the ATC chief/ATC SR SGT/PSG/ATC facility chief shall coordinate with the airfield commander or the senior field aviation commander supported. These procedures should include—

- NVD routes.
- Traffic density.
- Airfield lighting.
- Hours of operation.
- Traffic restrictions.
- Emergency procedures.
- Weather requirements.
- Nonparticipating traffic.
- Aircraft lighting (lights out or dim mode).

- Publication of a NOTAM, if required. Air traffic controllers shall be familiar with any exemptions or waivers, which may grant relief to the requirement of CFR 14, Part 91.209 concerning aircraft lighting requirements.

Traffic Patterns, Runways, or Landing Areas

4-71. Besides the above procedures, the ATC chief/ATC SR SGT/PSG/ATC facility chief shall ensure that both lighted and unlighted aircraft do not use the same traffic pattern, runway, or landing area. The chief shall also ensure that a NOTAM is published if the rotating beacon is to be turned off. If the glare from facility windows or other lights makes it difficult for the controllers to see and separate NVD traffic, the airfield commander or aviation commander shall be advised that positive control cannot be provided. Provisions for advising the commander shall be included in an LOA with the user.

Note: During aircraft NVD training when aircraft and airfield lighting systems are turned off, controllers are required to use NVDs.

Chapter 5 Reference Material

This chapter discusses the procedures used to maintain reference materials at each facility. It includes information on types of files, charts, diagrams, maps, administrative correspondence, and operating records and forms.

SECTION I – REFERENCE FILES, CHARTS, DIAGRAMS, AND MAPS

5-1. The ATC chief/ATC SR SGT/PSG/ATC facility chief shall maintain a current set of facility directives, letters of agreement (LOAs), FAA handbooks and orders, Army regulations, field manuals, technical manuals, AIG messages, and facility training manuals. All references shall be immediately available to facility personnel for operations, reference, training, and study. Appendix B lists the publications that are basic to ATC facility operations and training. The ATC chief/ATC SR SGT/PSG/ATC facility chief shall determine if additional publications are required to support operational or training needs. Reference material shall be arranged in loose-leaf binders, labeled in accordance with AR 25-400-2, and kept in a bookcase, rack, or other suitable container. Required reference materials may be maintained on computer recorded media (such as, hard drive, CD, zip drive, floppy disk) provided that controllers and maintainers have immediate access to the current material. However, the recent information and operating position files, charts, diagrams, and maps will not be maintained on recorded media. Media will be listed, labeled, and stored in accordance with AR 25-400-2. The

CONTENTS

Section I – Reference Files, Charts,

Diagrams, and Maps 5-1

Facility Reference File 5-2

Controller Reference File..... 5-2

Recent Information File 5-2

Operating Position Files 5-2

Charts, Diagrams, and Maps..... 5-3

Section II – Administrative

Correspondence 5-4

Letters of Agreement 5-4

Letters of Procedure 5-7

Operations Letters 5-10

Facility Memorandums 5-11

Section III – Operating Records and

Forms..... 5-12

Operational Hazard Report..... 5-12

Training and Proficiency Record–Air

Traffic Controller and

Trainee/Controller Evaluation..... 5-13

ATC Facility Personnel Status Report.. 5-13

Tactical Approach Publications System5-18

ATC Maintenance Personnel Certification

and Related Training Record. 5-19

Records Review and Retention 5-22

Contests and Appeals 5-22

GCA Operations Log 5-22

Daily Report of Air Traffic Control Facility 5-26

Air Traffic Control Position Log..... 5-27

Flight Progress Strips 5-28

ATC chief/ATC SR SGT/PSG/ATC facility chief will ensure that the publication quantity requirements of this FM and AR 95-2, table 12-1, and figures 12-1 through 12-3 are met in a paper, recorded media, or combined format. Internet/intranet links to required reference materials are not authorized.

FACILITY REFERENCE FILE

5-2. The ATC chief/ATC SR SGT/PSG/ATC facility chief shall establish and maintain a complete reference file of the written material required for facility operations. This file shall be maintained in the ATC chief/ATC SR SGT/PSG/ATC facility chief's office.

5-3. As a minimum, the facility reference file shall include the publications listed in appendix B. This file should also contain copies of FTMs, SOPs, operating manuals, and other materials of value to controllers and facility operations. At dual ATC facilities (TWR and GCA), one facility reference file may be used by both facilities. However, separate files may be justified because of the geographic separation of the facilities or the large number of controllers.

CONTROLLER REFERENCE FILE

5-4. The publications listed in appendix B are required to support daily operations; they shall be readily available to controllers in facility operating positions. Dual ATC facilities shall maintain separate controller reference files. The facility reference file may also serve as the controller reference file (installation facilities only) when the ATC chief/ATC SR SGT/PSG/ATC facility chief's office and facility operations are located in the same room.

RECENT INFORMATION FILE

5-5. The ATC chief/ATC SR SGT/PSG/ATC facility chief shall maintain an information file in a folder, binder, or clipboard. The file shall be used to post shift schedules and new information about facility operations. This file is temporary. Items are removed and filed in accordance with AR 25-400-2 after all personnel have initialed the document. It shall be readily available to controllers in facility operating positions. Each controller shall read and initial new directives, changes, or other materials before assuming a control position. Items may be removed from the file when all controllers have initialed them.

OPERATING POSITION FILES

5-6. Each facility will maintain operating position files in a loose-leaf binder or some other suitable display file. These files shall be available for each operating position so all controllers have an immediate source for confirming data or obtaining information. To determine what to include in the files, the ATC chief/ATC SR SGT/PSG/ATC facility chief must decide what material applies to each position.

5-7. All local procedures and instruction handbook materials pertaining to a certain operating position will be identified, defined, and maintained. For example, an arrival control position file should include LOAs, operations

letters, memorandums, and other documents pertaining to arrival control procedures.

5-8. Mandatory items for operating position files include—

- Instructions dealing with airfield emergencies (such as in-flight/ground emergencies, hijacking, bomb threats, facility evacuation, and position-specific responsibilities).
- A list of suitable airports, as determined by the facility chief, showing runways, type of surface lighting, and distance and bearing from the facility.

5-9. Suggested items for operating position files include—

- Instrument departure procedure diagrams.
- Photographs or exact depictions of a radarscope adjusted to optimum.
- Extracts from LOAs, LOPs, operations letters, and facility memorandums.
- A photograph or exact depiction of a video map superimposed over radar-ground returns to aid in determining the accuracy of the scope alignment.

CHARTS, DIAGRAMS, AND MAPS

5-10. Each ATC facility, control tower, radar facility, and flight-following facility shall maintain certain charts, diagrams, and maps for reference. The requirements for these materials are given below.

- **ATC facility.** Each ATC facility shall maintain current crash grid maps, sunrise and sunset tables, and flight information publications.
- **Control tower.** Each control tower shall develop and maintain the following diagrams and charts:
 - **Airfield diagram.** The airfield diagram shall depict runways, ramps, blind spots, ILS-critical areas, helipads, wind equipment, and RT groups. The ATC facility chief shall review the chart annually and post the date of review to the chart.
 - **Intersection-takeoff diagram.** The intersection-takeoff diagram shall depict distances remaining rounded down to the nearest 50 feet. (for example, 4,075 would be rounded down to 4,050 and 10,045, to 10,000.) The intersection-takeoff diagram maybe incorporated into the airfield diagram provided no information is omitted and the diagram remains legible.
- **Visibility Charts—**
 - **Installation.** The ATC facility chief and weather support personnel shall prepare a chart of day and night visibility markers. They may use panoramic photographs marked with distances and cardinal compass points. Each marker shall be identified and its distance from the tower noted. The height of the marker also shall be noted if used for estimating heights of clouds and obscuring phenomena. The ATC facility chief and weather personnel will review these charts

annually; both personnel conducting the review will annotate their name and the date on the chart.

- **Tactical tower.** Tower facilities shall prepare a generic visibility chart for use on deployments. Once the field site is established, the PSG/ATC facility chief shall coordinate with weather personnel to establish usable visibility markers. Once approved, the date will be posted on the chart.
- **Radar facility.** Each radar facility shall keep a runway diagram of each airfield it services and a map of the facility's jurisdiction area. The map shall depict airfields, NAVAIDs, Class D airspace, area and section boundaries, MOA restricted and prohibited areas, airways, and prominent objects. The facility shall also maintain a video map, if the capability exists, and an MVA chart. Chapter 3 contains details about video maps and MVA charts.
- **Flight-following facility.** Each flight-following facility shall keep an up-to-date map of its area of responsibility. Chapter 3 contains additional information about flight-following procedures.

SECTION II – ADMINISTRATIVE CORRESPONDENCE

5-11. The ATC facility shall maintain a file of administrative correspondence. This correspondence should include LOAs, LOPs, operations letters, and facility memorandums.

LETTERS OF AGREEMENT

5-12. LOAs may apply to a specific facility, a group of facilities, or all facilities within a designated geographical area. LOAs are prepared between the U.S. Army and other services or a host nation. They are also prepared between centers and towers, centers and terminal radar facilities, or ATC facilities located on the same or different airfields. The ATC chief/ATC SR SGT/PSG/ATC facility chief shall prepare LOAs to—

- Delegate areas of control jurisdiction and the conditions of use.
- Define special operating conditions or specific ATC procedures.
- Define interfacility or interagency responsibilities and coordination requirements.
- Describe procedures or minima that deviate from or is not contained in, FAAO 7110.65, this manual, or other pertinent directives.

5-13. The ATC chief/ATC SR SGT/PSG/ATC facility chief responsible for developing an LOA shall—

- Confine the material in each LOA to a single subject or purpose.
- Ensure that the LOA is properly prepared.
- Describe the responsibilities and procedures that apply to each facility and organization involved.
- Attach charts or other visual presentations, as appropriate, to depict the conditions of the agreement.
- Delegate responsibility for air traffic control. He shall describe the area in which the responsibility is delegated and define the conditions

governing the use of that area. He shall also specify and explain the control, communications, and coordination procedures.

- Coordinate the LOAs with the appropriate facilities, agencies, and authorities.
- Coordinate and forward all proposed LOA to the appropriate USAASD-E/EUSA/DARR before a LOA is signed. The DARR shall review and coordinate them, then return them to the originator with comments. LOAs between U.S. Army ATC units located on the same or adjacent airfields do not require the involvement of the DARR.
- Establish the effective date of the LOA at 30 days after its distribution. This will give the participants time to familiarize their personnel with the agreement and revise directives and flight charts.
- Prepare the letter in final form.
- Sign the letter and obtain the other required signatures.
- Distribute copies of the signed LOA, according to the distribution stated in the letter.

5-14. A change in the requirements of any party signing the agreement will create the need to rewrite or amend the letter. Revisions, attachments, or supplements to LOAs shall be processed as page replacements. They shall be coordinated the same as the original letters. Revisions shall be marked as follows:

- Place an asterisk to the left of each new or revised paragraph or section to signify that it is new material.
- Identify page revisions by the revision (REV) number (for example, REV 1). Enter the effective date in the lower right corner of each revised page.

5-15. To ensure timeliness and conformance to current policies and directives, the ATC chief/ATC SR SGT/PSG/ATC facility chief shall review all facility LOAs annually no later than the anniversary month of the original document. He shall also sign and date the annual reviews. Figure 5-1 shows a sample format for an FAA or a U.S. Army LOA.

(Name) Air Route Traffic Control Center and (Name) FAA (Name) Approach Control and (Name)

LETTER OF AGREEMENT

EFFECTIVE: (Date)

SUBJECT: Special VFR Operations Within (Name) Airport Surface Area

1. PURPOSE: (List responsibilities, and describe necessary coordination.)
2. CANCELLATION: (Use as required.)
3. SCOPE: (Specify areas having ATC responsibility and names and types of facilities.)
4. RESPONSIBILITIES: (Specify responsibilities.)
5. PROCEDURES:
 - a. ATC-assigned airspace. (List the procedures for requesting and authorizing airspace, handling aircraft to and from airspace, and notifying ATC when the airspace is no longer required.)
 - b. Transfer of control. (Specify transfer procedures.)
 - c. Departures. (Specify the required advance time for filing flight plans, and outline additional items required in the flight plan. For example, list the type of departure and the control transfer points.)
 - d. En route. (Include in this information that ATC is responsible for effecting separation in assigned airspace when nonparticipating aircraft are cleared to operate within that airspace.)
 - e. Arrivals. (Outline handoff procedures and special instructions.)
 - f. General. (Include, if appropriate, missed-approach procedures, special VFR operations, and provisions for handling movement of national-defense aircraft in emergencies.)
6. ATTACHMENTS: (List, as required, items such as a chart of ATC-assigned airspace areas and common reference or handoff points.)

Airfield Commander, (Name) AAF Chief, (Name) ARTCC

Chief, (Name) ATC Facility Director, (Name) Region

(Name and title of appropriate authority)

Figure 5-1. Sample Format for an FAA or a U.S. Army LOA

LETTERS OF PROCEDURE

5-16. LOPs should be prepared using AR 25-50 and FAAO 7610.4 as administrative guidelines. Ensure LOPs are worded so the Army maintains the greatest degree of mission flexibility within limits prescribed by law or regulation. Care must be taken to choose the appropriate subject matter, terminology, and correct procedures when negotiating the content.

5-17. AT&A officers must ensure LOPs are negotiated when an operational/procedural need requires the cooperation or concurrence of other facilities/organizations. LOPs shall be prepared when it is necessary to—

- Define SUA responsibilities.
- Supplement established operational/procedural instructions.
- Define responsibilities and coordinating requirements.
- Establish or standardize operating methods.
- Describe airspace to segregate special operations.
- Specify special operating conditions.
- Specify special operational conditions or specific air traffic control procedures.

5-18. LOP criteria governing SUA shall include as a minimum—

- Scheduling procedures and updates, to include requirement and time parameters for providing updates to the schedule.
- Activation/deactivation procedures.
- Activation/deactivation times.
- Authorized (signed) by the affected ATC facility manager and the military representative of the originating or scheduling activity.
- Address transfer of airspace during emergency conditions. In the event of a bona fide emergency, the using agency may approve the controlling agency's request for use of SUA. The using agency, when notified by an FAA manager/supervisor of an emergency, will transfer the airspace to the controlling agency as soon as safety permits. The controlling agency will return the airspace to the using agency when the emergency traffic situation is resolved.
- The using agency will approve/disapprove the controlling agency's request to use SUA for situations caused by weather, by assessing the immediate situation and its impact on Army and civil aircraft operations. The decision will be made based on a request from an FAA supervisor and imminent/existing weather conditions (not traffic flow). Weather conditions that require special considerations are tornadoes, hurricanes, blizzards, etcetera. The controlling agency will return the airspace to the Using Agency within 30 minutes after the weather situation is no longer a factor.

Note: The controlling agency will provide using agency, upon request, an after action report (AAR) when SUA is transferred.

5-19. LOPs will be processed in accordance with AR 95-2, the AT&A officer shall coordinate an LOP with the appropriate DARR prior to discussions with the FAA, during development, and when modifications are made. Provide the DARR a detailed explanation of the purpose of the LOP to include a copy of

the concept of operation, if applicable. If an AT&A officer is not available, the unit commander or designed representative may need to coordinate directly with the DARR.

5-20. Forward all LOPs to the DARR for review at least 45 days prior to the desired implementation date. Activities/agencies that do not have a DARR, may forward their documents directly to: USAASD-E (locations in Europe, Africa, and the Middle East), EUSA ATS Office (Korea), and HQ, USAASA for all other areas. Include the following:

- A cover memorandum, must include any changes to existing LOP, along with background information for each change. If the LOP is new, a brief description of the operation should be outlined. The unit commander shall approve/sign memorandum.
- DARR endorsement will recommend approval or disapproval of the LOP, and any recommended changes.
- Leave effective date and signatures blank until all coordination is complete and all comments are considered and incorporated as required. Once this has been accomplished, establish an effective date, acceptable to all parties involved. This permits sufficient time for distribution and for participating facilities and user groups to familiarize personnel, revise directives, flight charts, etcetera, and complete other actions as necessary.

5-21. Review of LOPs will be in accordance with AR 95-2. Review each LOP at least once annually. DARR review is mandatory. Figure 5-2 is an example LOP.

(EXAMPLE)

JOINT USE RESTRICTED AREA LETTER OF PROCEDURE

SUBJECT: Joint use letter of procedure for use of restricted areas R-0000A, R-0000B, R-0000C, R-0000D, R-0000E

EFFECTIVE: 25 December 2002

In accordance with AR 95-2, AR 385-63, FAAO 7610.4, and FAAO 7400.8D, this letter establishes following procedures for the joint use of restricted areas R-0000A, R-0000B, R-0000C, R-0000D, R-0000E between: Jacks Air Route Traffic Control Center (controlling agency), Commander, Fort Every (using agency), Fort Every Range Control (scheduling agency), and Fort Every Army Approach Control (ARAC).

CANCELLATIONS: This letter of procedure cancels the (Title of previous letter) Joint use of letter of procedures, same subject, dated 1 April 2001.

PROCEDURES:

1. ARAC:

- a. Inform controlling agency of activation/deactivation times for R-0000A, R-0000B, R-0000C, R-0000D, R-0000E.
- b. Notify controlling agency 30 minutes prior to activation of special use airspace via landline.
- c. When notified by controlling agency manger/supervisor personnel of an emergency, Army supervisor will assess the immediate situation and its impact on Army and civil aircraft operations and make a decision to return/denial request for use of restricted area (s).
- d. When controlling agency manger/supervisor requests use of restricted airspace for a situation caused by weather, Army supervisor will make a decision to release/deny request based upon imminent/existing weather conditions (not traffic flow). Examples of weather conditions that require special considerations are tornadoes, hurricanes, blizzards, etcetera.

2. Controlling agency:

- a. Will coordinate with the using agency for use of the designated restricted airspace when not in accordance with FAAO 74008.
- b. Shall return designated airspace to the using agency within 30 minutes of request.

3. Scheduling agency:

- c. Shall coordinate schedule changes between ARAC and controlling agency.
- d. Shall forward, as soon as possible, schedule changes to the controlling agency, via dedicated or commercial line.

EXECUTED:

Signed

Title

Date

DARR Review By/Date:

Signed

Title

Date

Figure 5-2. Example Format for a LOP

OPERATIONS LETTERS

5-22. Operations letters apply between ATC facilities and other US Army agencies, or units located on the same airfield or heliport (such as, ATC towers and base operations or fire station/crash rescue). The ATC chief/ATC SR SGT/PSG/ATC facility chief shall prepare operations letters to—

- Supplement established operational or procedural instructions.
- Establish or standardize operating methods.
- Establish responsibilities to—
 - Operate airport equipment.
 - Provide emergency services.
 - Exchange braking action reports with the airport management. (As a minimum, procedures shall cover the prompt exchange of reports indicating runway-braking conditions have deteriorated to "poor" or "nil" or have improved to "good.")
 - Report operating limitations and hazards.
- Define the responsibilities of the tower and the airport management or other authority for movement and nonmovement areas.

Note: Operations letters are not written between ATC facilities these actions require a LOA.

5-23. Appropriate subjects of operations letters between the tower and airport management/aircraft operator include—

- Airport emergency service.
- Airport lighting operation.
- Airport condition reporting.
- Vehicular traffic control on airport movement areas.

5-24. The ATC chief/ATC SR SGT/PSG/ATC facility chief responsible for developing an operations letter shall—

- Confine the material in each letter to a single subject or purpose.
- Ensure that the operations letter is properly prepared.
- Describe the responsibilities and procedures that apply to the facility and organization involved.
- Attach charts or other visual presentations to depict the conditions or circumstances stated in the letter.
- Coordinate the letter with the airfield commander before initiating any other coordination.
- Coordinate the letter with the appropriate facilities, agencies, or authorities.
- Obtain approval of the operations letter.
- Establish an effective date that allows time for participating facilities and agencies to familiarize their personnel with the contents of the letter and to complete other preimplementation actions.
- Prepare the letter in final form.
- Sign the letter and obtain the other required signatures.

- Distribute copies of the signed letter to the appropriate facilities or agencies.

5-25. All parties concerned shall retain a copy of the operations letter and review it annually no later than the anniversary month of the original document. The ATC chief/ATC SR SGT/PSG/ATC facility chief shall date and sign the annual review. Figure 5-3 is a sample format for a control tower or an airfield operations letter.

5-26. A change in the requirements of any party signing the operations letter requires rewrite or revising the letter. However, a change in key personnel does not require a rewrite or revision. Rewrites or revisions shall be processed as page replacements and be coordinated the same as the original letter. Revisions shall be marked as follows:

- Place an asterisk to the left of each new or revised paragraph or section to signify that it is new material.
- Identify page revisions by the REV number (for example, REV 1). Enter the effective date in the lower right corner of each revised page.

Operations Letter Between <u> (Name) </u> Airfield Operations and <u> (Name) </u> Control	
Tower <u> (Name) </u> Airfield Operations Letter No <u> </u>	
<u> (Name) </u> Control Tower Letter No <u> </u>	
SUBJECT: (Write a short statement to describe the contents of the letter.)	
EFFECTIVE: (Enter the effective date of the letter and the number of cancelled letters.)	
(Write a paragraph to outline the text of the letter. Give enough detail to preclude a misunderstanding of the intended procedures and responsibilities and required coordination.)	
<u> (Signature) </u> Airfield Operations Officer	<u> (Signature) </u> ATC Chief/ATC SR SGT/PSG/ATC Facility Chief, Tower Name Airfield Name
DISTRIBUTION: (as appropriate)	

Figure 5-3. Sample Format for a Control Tower or an Airfield Operations Letter

FACILITY MEMORANDUMS

5-27. The ATC chief/ATC SR SGT/PSG/ATC facility chief shall issue facility memorandums when internal facility operations must be regulated and standardized. Memorandums will contain instructions on the administrative or operational practices and procedures within the facility. The ATC chief/ATC SR SGT/PSG may issue a memorandum as a joint document when it applies to two or more ATC facilities under his jurisdiction.

5-28. Facility memorandums will follow the standard Army memorandum format in accordance with AR 25-50 and be numbered in sequence (02-1, 02-2 meaning the first/second memorandum for 2002). They will be limited to one subject, operation, or procedure; enclosures and attachments may be included. Facility memorandums shall be reviewed for currency annually no later than the anniversary month of the original document. The ATC chief/ATC SR SGT/PSG/ATC facility chief shall date and sign the annual review.

SECTION III – OPERATING RECORDS AND FORMS

5-29. Facility records shall be managed according to the procedures in AR 25-400-2 and as directed by the servicing adjutant general. They are a part of the facility's permanent records and subject to review by authorized personnel or agencies. No records, recorded or written, shall be released without permission from the ATC chief/ATC SR SGT/PSG/ ATC facility chief and after coordination with the airfield commander (installation) and ATS unit commander. Entries on all facility operating forms shall be neat and accurate. When practical, entries should be typewritten (computer generated forms may be used); however, entries may be printed in ink. Incorrect entries will not be erased or struck over. When an entry must be corrected, a line will be typed or drawn through the incorrect portion and the correct entry made. The controller correcting the error shall initial the correction. Blank copies of the reproducible forms prescribed in this manual are in the back of this manual. Electronic forms may be downloaded from <http://www.usapa.army.mil/>. These forms may be reproduced locally on 8 1/2- by 11-inch paper. Instructions for completing DA Form 3501-R (*GCA Operations Log*), DA Form 3502-R (*Daily Report of Air Traffic Control Facility*), and DA Form 3503-R (*Air Traffic Control Position Log*) are given in paragraphs 5-44 through 5-55.

OPERATIONAL HAZARD REPORT

5-30. Controllers that witness procedural or material operational hazards or unsafe ATC practices or procedures shall submit DA Form 2696 (*Operational Hazard Report*) to their supervisors. Procedures covering the completion and disposition of DA Form 2696 are covered in AR 385-95. The ATC chief/ATC SR SGT/PSG/ATC facility chief shall ensure that blank copies of this form are available. He shall also ensure that completed forms are correct and submitted through the appropriate commander to the local aviation safety officer or airfield operations officer.

5-31. Information copies of DA Form 2696 pertaining to Army ATC procedures shall be forwarded to Commander, USAAVNC, ATTN: ATZQ-ATC, Fort Rucker, Alabama 36362-5265. Information copies of completed forms shall be retained at the facility until final action has been completed. The FTM shall include instructions for preparing and submitting DA Form 2696.

5-32. Operational hazard reports are not to be used to report alleged flight violations for punitive action. AR 95-1 provides guidance for processing alleged flight violations.

TRAINING AND PROFICIENCY RECORD—AIR TRAFFIC CONTROLLER AND TRAINEE/CONTROLLER EVALUATION

5-33. Chapters 6 and 7, and appendix A of this publication covers the preparation, retention, and distribution of DA Forms 3479-R and 3479-1-R.

ATC FACILITY PERSONNEL STATUS REPORT

5-34. All facilities authorized or assigned U.S. Army, Army National Guard, DAC, contract, air traffic controllers or ATC maintenance personnel shall prepare and submit DA Form 3479-6-R (*ATC Facility and Personnel Status Report*) or an automated version of the form within the first 15 workdays of the succeeding calendar month. All Army Reserve units shall submit DA Form 3479-6-R quarterly based on a calendar year. The units shall forward this completed unclassified form to the MACOM headquarters through the normal chain of command. They also shall send a copy directly to Commander, USAAVNC, ATTN: ATZQ-ATC, Fort Rucker, Alabama 36362-5265. All installation ATC facilities shall provide the local airfield commander with a copy of the monthly traffic record (block 11 of the form). The responsible commander or his designated representative will verify the accuracy of the report. Instructions for completing DA Form 3479-6-R are given below.

Note: If there is an advantage in doing so, this form or data may be transmitted by electronic means.

- **Block 1. Unit.** Enter the agency, battalion, company, platoon, or detachment having command of the ATC facility, branch, division, element, or section identified in the report. Include the mailing address of the city, post, or station.
- **Block 2. Facility/Branch/Division/Element/Section.** Enter the name, title, or number of the section to which ATC personnel being reported are assigned (for example, Forney Army Airfield, Hanchey Army Helipoint, 1st Platoon, or 3d Platoon).
- **Block 3. Date.** Enter the month and year the report covers in the following format: Mmm YY (Dec 02).
- **Block 4. Hours of Operation.** Enter the number of hours per day and days per week that each facility or staff element operates. More than one entry may be required to indicate different hours of operation. (for example, Monday through Friday/16 hours [M-F/16] or Saturday, Sunday, and Holidays/8 hours [S-S-H/8].)
- **Block 5. Manned Positions.** Enter an X under each position normally manned by an individual dedicated to that position during each shift. If an individual is normally responsible for more than one position during a given shift, show position responsibility by entering C1 under each position. (For example, show the normally combined positions of GC and LC by placing C1 under each position for that shift.) If more positions are combined and assigned to a second individual, enter C2 under these positions. Shift A shall be the first shift of the day (for example, 0600-1400 or 0700-1500). Shift B shall be the second shift of the day, and Shift C shall be the third shift of

the day. The facilities that normally do not operate on weekends and holidays shall use shift D for those periods.

Note: The appropriate acronyms shall be used for position titles. If the appropriate acronyms are not listed in the glossary of this publication, local acronyms shall be used in block 5 and defined in block 9, Remarks.

- **Block 6. TDA Authorizations (by MOS).** Enter both controller and maintenance ATC personnel by MOS (or job series for civilians); follow with the authorized total and on-hand total (for example, 93C-5/4, 2152-2/2, 35D-2/1, or 0856-1/2). Do not indicate skill levels. DA Form 3479-6R reporting is for the status of the facility/section on the last day of the month. All personnel on special duty (SD) or temporary duty (TDY) are considered on-hand at the losing facility/section for reporting purposes. Any person that has PCS, transferred, ETS, terminated employment, or is on terminal leave during the course of the month (to include the last day) is no longer on-hand at the end of the month.
- **Block 7. TOE Authorizations (by MOS).** Enter totals the same way as in block 6.
- **Block 8. Aircraft Activity (by Shift).** Enter the total aircraft activity for each shift. Using the installation facility criteria (see instructions in block 11), report the aircraft activity for tactical ATC exercises by shift only. For installation facilities, the totals in block 8 shall be the same as the totals in block 11.
- **Block 9. Remarks.** Use this block to explain any entry in blocks 1 through 8.
- **Block 10. Personnel.** Enter alphabetically, by facility or section, all assigned military and civilian controller, and maintenance personnel. Complete block 10 as shown below.
 - Column (a) Name. Enter the individual's last name, first name, and middle initial.
 - Column (b) Rank. Enter the rank for military and pay grade for civilian employees (for example, SSG, GS 11, or WG 10).
 - Column (c) MOS. Enter the individual's primary MOS. For civilians, enter 2152 or 0856, as appropriate.
 - Column (d) ETS. Enter the individual's current ETS/RCP date (military only).
 - Column (e) ATCS No. Enter the individual's assigned ATCS certificate number.
 - Column (f) Date Assigned. Enter the date the individual was assigned to a tactical section or facility for training. Enter a new assigned date each time an individual is moved geographically or is moved from one facility to another within the same facility complex (for example, Heidelberg to Wiesbaden or tower to GCA). If dual rated, the date assigned will be the facility/section of primary assignment.
 - Column (g) Date Rated. Enter the letter T for trainee. Enter the date the individual was issued a facility rating for that

facility. This date shall correspond to the date entered on the back of the ATCS certificate. If, for example, an individual is rated in tower and working in GCA, make no entry in this column until he becomes rated in GCA. Annotate the tower rating, however, in the Remarks column. The same procedures will be used to denote tactical training and ratings. If dual rated, the date rated will be the facility/section of primary assignment.

- Column (h) Remarks. Enter the following information, as applicable:
 - The gaining unit shall list SD personnel and indicate the primary unit.
 - The primary unit shall list SD personnel and indicate the location of the SD.
 - Indicate when an individual is a 90, 60, and 30-day loss for ETS or PCS loss. The baseline for reporting a projected loss is that any inclusive date of the departure month is considered the first day of the month. Show the PCS moves in this block for the month following the PCS. Enter the date of departure and destination if PCS. For PCS losses, indicate the estimated time of arrival at the new location. Attach the ATCS certificates for ETS personnel to the DA Form 3479-6-R submitted for that month. Units that report their DA Form 3479-6-R electronically shall ensure that surrendered ATCS certificates are mailed IAW the standards associated with the paper-filed format.
 - Enter REQ if making a request for reissuance of an ATCS certificate. State the reason for the request, such as lost, worn, or name change; indicate the date the individual completed ATC School. These entries shall remain in the Remarks column until the individual receives a new ATCS certificate.
 - Enter primary and additional ATC duty assignments (for example, facility chief, training supervisor, or examiner).
 - Enter the training status and cumulative downtime (for example, PQ FD/GC, 10 days CDT).

Note: (Installation Only) Cumulative Downtime (CDT) is any authorized reason to stop ATC training as defined in chapter 4 of AR 95-2 and any time a trainee cannot dedicate at least four hours to ATC training, that day will be considered CDT. Normal days off, holidays, and leave other than emergency leave are not counted for CDT.

- Enter the number of calendar months an individual is extended with a training time extension (TTE) and the expiration date of the extension. An approved TTE starts the day after the initial rating period ends. The TTE expires the same day on a later calendar month. Include

the reason the individual did not become rated, qualified, or certified in the prescribed time. If a training time extension has been granted, start CDT over with zero on the start date of the TTE.

- Enter groundings, and include the estimated date for return to duty. List the reason for grounding using one of the following terms: positive urinalysis, medical, administrative, or disciplinary.
- Enter reclassification actions. An individual being reclassified remains on report with no ATCS number until reclassified.
- State the reason for suspension (or example, apathy, lack of ability, or pending medical evaluation).
- Enter the reason an individual is not working in the facility or unit or the reason training is not being conducted (for example, emergency leave, field exercise, unit training NCO, or ETS).
- Enter the Social Security number of newly assigned individuals.
- Enter the dual rating (for example, TWR/GCA).
- Enter any other data (for example, maintenance certified [AN/TSQ71B, FPN-40], pathfinder, tactical certification, or additional skill identifiers as appropriate).

Notes: The following abbreviations and acronyms shall be used to complete the form: cumulative downtime (CDT), date training starts (DTS), emergency leave (emg lv), estimated date of return (EDR), estimated date of arrival (EDA), field training exercise (FTX), medical grounding (med gd), reclassification (reclas), training time extended (TTE), training time resumed (TTR), positive urinalysis (PUA), and training time stopped (TTS).

All dates shall be entered numerically by day, month and year; for example, 21 August, 2002, will be entered as 21 Aug 02.

- **Block 11. Monthly Traffic Record (installation facilities only).** In addition to the data in block 8, Installation ATC facilities shall maintain a monthly traffic count in the following categories:
- **Block 11a.** Enter the name of the AAF/AHP
 - **Military aircraft, air carriers, and general aviation aircraft.** Maintain a separate count of activity for military aircraft, air carriers, and general aviation aircraft in installation control towers, approach control facilities, and ground-controlled approach facilities.

- **Block 11b and 11c. Tower-IFR and Tower-VFR.** Movement by (1) local and (2) transient aircraft. Use the following criteria to count control tower activity:
 - Count a single aircraft arrival, departure, or overflight as one.
 - Count a single aircraft touch-and-go, stop-and-go, low approach, missed approach, or wave-off/go-around below the traffic pattern altitude as two.
 - Count formation flights according to the number of aircraft in the formation. (For example, count a flight of two aircraft flying a low approach as four and a flight of two aircraft making a full stop as two.)
 - Count helicopters that remain within the airport traffic area while on air taxi to or from working or alert areas the same as departures or arrivals. Enter the count in the tower VFR local column.
 - Count UAV traffic the same as manned aircraft. Tower-VFR movement by (1) local and (2) transient aircraft.
- **Block 11d. ARAC (not to include final) by (1) IFR and (2) VFR.** Use the following criteria to count approach control activity:
 - ARTS/STARS has the capability for automated traffic count and should be used to the fullest extent. Unique traffic that cannot be programmed into the automation system will be counted and added to the automated count manually.
 - Count aircraft operations the same as tower operations. However, count formation flights as only one operation.
 - Count aircraft as instrument operations when they are provided separation regardless of existing weather conditions or type of flight plan.
 - Count VFR operations, and enter them in the same format and category as instrument operations (for example, military, air carrier, and general aviation).
 - Count UAV the same as manned aircraft.
- **Block 11e. GCA radar vector (pattern).** Count each GCA pattern (vector), ASR final, and PAR final as one. When GCA/ASR radar is used for range monitoring/flight-following of UAV aircraft, the provisions established for flight-following facilities will be used. If active separation from other UAVs or manned aircraft is applied, IFR count will apply.
- **Block 11f. GCA/ARAC (1) final ASR and (2) final PAR.** Count each GCA ASR final, and PAR final as one. When GCA/ASR radar is used for range monitoring/flight-following of UAV aircraft, the provisions established for flight following facilities will be used. If active separation from other UAVs or manned aircraft is being applied, IFR count will apply.
- **Block 11g. AIC/tower flight following (total count).** Use the following criteria to count total flight-following activity:
 - Count the initial contact with an aircraft as one.

- Count formation flights as a single operation.
 - Count each position report made while the aircraft is en route as one. (To be counted, the position report must be posted to the flight progress strip.)
 - Count each aircraft entering or departing an unmanned area (restricted area, range and NOE, NVD route) as one. (To be counted, this data must be posted to the flight progress strip.)
 - Count UAV traffic the same as manned aircraft.
- **Block 12. Date.** Enter the date the form was completed.
 - **Block 13. Prepared by.** Enter the name of the individual who completed the form and the telephone numbers (commercial, including the area code, and DSN). A signature is not required.
 - **Block 14. Last AIG received.** Enter the last AIG message received.
 - **Block 15a. Authentication officer.** Enter the name, title, office symbol, and telephone numbers (commercial, including the area code, and DSN) of the commander or civilian equivalent.
 - **Block 15b. Signature of authentication officer.** The commander or civilian equivalent signs this block.
 - **System outage reporting.** System outages involving ATC installation equipment will be reported to ATSCOM on a monthly basis as an attachment to DA Form 3479-6-R. Outages include all out-of-service conditions (for example: one channel of a dual-channel system out-of-service condition). The attachment will contain the following information:
 - Unit/organization.
 - Facility/airfield.
 - System/subsystem.
 - Serial number.
 - Date out of service (dd Mmm yy).
 - Date returned to service (dd Mmm yy).
 - Not-mission-capable maintenance hours.
 - Not-mission-capable supply hours.
 - Reason for outage.
 - Restore method: (action(s) taken to return system to fully mission capable status).

TACTICAL APPROACH PUBLICATIONS SYSTEM

5-35. Critical information about tactical approach procedures at instrumented heliports and airfields must be distributed to aviators. The ATS LNO shall ensure that TERPS and any other critical information are included in the ACO as a complement to the ATO.

5-36. The platoon sergeant or designated ATC facility chief will develop T/SIPs and apply the TERPS in TM 95-226 to obstacle clearance criteria. He is also responsible for preparing TAPS messages and distributing them to the ATS battalion TOC. The messages must be prepared accurately and sent by

the most expeditious means. Some information in the TAPS message may be classified and shall be transmitted and handled as such. A copy of each message shall be forwarded to the ATS LNO of the airspace management element to be further disseminated to participating aviation units.

5-37. DA Form 3479-8-R (*Tactical Approach Publications System*) shall be completed as explained below. A blank copy of this reproducible form is at the back of this manual.

- **Line 1.** Enter the airfield coordinates.
- **Line 2.** Self-explanatory.
- **Line 3.** Enter the SOI version or item number.
- **Line 4.** Self-explanatory.
- **Line 5.** Enter the final approach course to the NDB.
- **Line 6.** Self-explanatory.
- **Line 7.** See TM 95-226.
- **Lines 7A and 7B.** Self-explanatory.
- **Lines 8 and 9.** See TM 95-226.
- **Line 10.** Enter the height or MDA above the landing area (visibility requirement).
- **Line 11.** Enter the geographic location of the landing area (for example, north or southwest).
- **Line 12.** Enter the landing area distance from the NDB in feet. (If the distance is off the airport, use miles and fractions of miles.)
- **Line 13.** Enter the SOI version or item number.
- **Line 14.** Self-explanatory.
- **Line 15.** Enter the final approach no-wind heading.
- **Line 16.** Self-explanatory.
- **Line 17.** Enter the decision height above TDZE (visibility requirement).
- **Line 18.** Enter the type of airport lighting.
- **Line 19.** Enter the missed approach point (as needed). This line may be used—
 - To prescribe factors for standard NDB approaches.
 - To report the status of flight checks.
 - To issue special warnings such as obstructions in the airport area.
- **Line 20.** Self-explanatory.

ATC MAINTENANCE PERSONNEL CERTIFICATION AND RELATED TRAINING RECORD

5-38. DA Form 3479-9-R (*ATC Maintenance Personnel Certification and Related Training Record*) will be used to maintain a record of the status of each individual in the certification program for the associated facility/shop. It specifies the technician's certification authority by the system/subsystem/equipment for which there is an associated examination. The information on the form shall include (but is not limited to)—

- All certification authority issued, including interim.

- All certification-related schooling, correspondence study, OJT, out-of-house training, and certification program examinations. The information shall also include examination results (passed, failed) and completion dates of the training and examinations.
- Signature/initials of responsible officials (maintenance chief/maintenance training personnel).
- The beginning and ending dates of acquired experience.
- The date that certification authority was revoked on specific systems/subsystems/equipment.

5-39. Instructions for preparing DA Form 3479-9-R are given below. All entries will be made in ink unless indicated otherwise.

- **Block 1. Name.** Enter the technician's name.
- **Block 2. SSN.** Enter the technician's SSN.
- **Block 3. Grade/Rank.** Enter (in pencil) the technician's grade/ rank; for example, GS-11 or SSG.
- **Block 4. System/Subsystem/Equipment.** Enter the specific system/subsystem/equipment on which the technician is qualified or will qualify (for example, AN/FRN-41(V), AN/TSQ-71B, FSC-92, or ASR-9).
- **Block 5. Theory.** In column a, enter the method by which system requirements were met (refer to footnote 1 or DA Form 3479-9-R). In column b, enter the date (DDMMYY) the technician successfully completed the theory (concepts) requirements (for example, 101199). In column c, the responsible official writes his initials.
- **Block 6. Performance.** In column a, enter the method by which performance requirements were met (refer to footnote 1 on DA Form 3479-9-R). In column b, enter the date (DDMMYY) that the technician successfully completed performance requirements. In column c, the responsible official writes his initials.
- **Block 7. Certification.** In column a, enter the date (DDMMYY) the certification authority requirements were fully met and the theory (concepts) examination was successfully completed (refer to footnote 2 on DA Form 3479-9-R). In column b, enter the date (DDMMYY) the certification authority was revoked.
- **Block 8. Duty Station.** Enter the technician's duty station (for example, Robert Gray AAF, Fort Hood or Company B, 164th ATS Group).
- **Block 9. Date of Action.** Enter the date (DDMMYY) of that particular action.
- **Block 10.** Enter the type of action or remarks that pertain to the entry in block 9.
- **Block 11. Maintenance Chief's Signature.** Self-explanatory.
- **Block 12. System/Subsystem/Equipment.** Enter the system/subsystem/equipment for which the technician took the training or examination.
- **Block 13. Course Number.** Enter the course number (for example, if applicable, the MOS (35D), FAA, or ASI course number).
- **Block 14. Training or Examination.** In column a, enter C or P (refer to footnote 3 on DA Form 3479-9-R). If the training or examination

does not pertain to either, leave blank. In column b, enter the edition number of the theory (concepts)/performance examination. In column c, record the results of the examination or course by entering either P or F (refer to footnote 4 on DA Form 3479-9-R). In column d, enter the completion date (DDMMYY) of the examination or course.

- **Block 15. Remarks.** Enter remarks pertaining to the technician's training; if desired, continue remarks on an attached sheet.
- **Block 16. Initials.** If the entries in blocks 12 through 15 pertain to examination results, the examiner writes his initials in block 16. If the entries pertain to training, the maintenance chief writes his initials in block 16.

5-40. **Responsibility Assignment.** DA Form 3479-9-R is used to evaluate a technician's progress toward becoming certified or to assess unsatisfactory progress in a training program. The technician will be told what he must do to improve and why. This information may include study assignments or additional OJT.

5-41. DA Form 3479-10-R (*Responsibility Assignment*) is also used to officially assign certification responsibility/authority to the technician. Instructions for completing DA Form 3479-10-R are given below.

- **Block 1. Type.** Enter an X in the appropriate box. Enter the revision number if applicable.
- **Block 2. Date.** Enter the date (DDMMYY).
- **Block 3. Page Number.** Self-explanatory.
- **Block 4. Name.** Enter the technician's name.
- **Block 5. Location.** Enter the technician's duty location (for example Fort Hood or Camp Stanley, Korea).
- **Block 6. Position Title and Rank/Grade.** Enter the position title and rank/grade of the technician.
- **Block 7. Immediate Supervisor.** Enter the immediate supervisor's name.
- **Block 8. Location/Phone Number.** Enter the location and office telephone number of the immediate supervisor.
- **Block 9. System/Facility/Equipment.** In column a, enter the type of equipment for which the technician is assigned responsibility (for example, AN/FRN-41(V)1, MARK 1F or MARK 20A). In column b, enter the identification of the station or location (for example, PTK CNS or Starns Beacon, Cairns Tower).
- **Block 10. Responsibility.** (Refer to maintenance and certification codes on the back of DA Form 3479-10-R.) In column a, enter the appropriate maintenance responsibility code. In column b, enter the appropriate certification responsibility code.
- **Block 11. Effective Dates.** Enter the effective starting and ending dates (DDMMYY) of the responsibility. The ending date is when the responsibility is no longer required or has been revoked.
- **Block 12. Comments.** Enter comments pertaining to certification responsibilities; if there are no comments, so state by entering "None."

- **Block 13. Special Instructions/Restrictions/Limitations/ Remarks.** Enter special instructions for restrictions/ limitations, and enter other remarks. (If certification code LC is entered in block 10, the limitations must be shown in block 13. If code SSC is entered in block 10, the equipment must be listed in block 13.)
- **Block 14. Technician.** Enter the technician's name, title, and grade/rank. The technician will sign in this block.
- **Block 15. Immediate Supervisor.** Enter the immediate supervisor's name. The immediate supervisor will sign in this block.
- **Block 16. Examiner.** Enter the name of the examiner (facility maintenance chief or battalion/company 35D personnel). The examiner will sign in this block.
- **Block 17. Copy to.** Enter an X in the box marked FILE if this is the file copy, and indicate who was given a copy of this DA Form 3479-10-R. If an X is entered in the OTHER box, specify the personnel or element receiving a copy.

Note: The names and titles may be printed rather than typed in blocks 14 through 16.

RECORDS REVIEW AND RETENTION

5-42. The maintenance chief must review the technician's folder contents annually and annotate "Annual Review" in blocks 8 through 11 of the DA Form 3479-9-R. As the technician becomes certified or completes related training, the record will be annotated within 15 days. Once the maintenance chief reviews and signs the records, all performance examination results will be placed in the order that the examinations were taken with the latest on top. These results will be retained in the record as long as equipment certification authority remains valid. These folders are permanent records and will remain active while an individual is an ATC maintenance technician. The records of an reclassified technician shall be returned to the individual upon completion of reclassification actions.

CONTESTS AND APPEALS

5-43. Trainees/technicians may agree or disagree with the review and make the comments that they feel are necessary. They will place their comments on a separate sheet and attach the sheet to the review. The reviewing authority ensures that the forms are filled out properly, makes the appropriate entries/comments, and signs and dates the form. The technicians may contest or appeal the entries on DA Form 3479-9-R. Complaints will be directed through channels to Commander, USAAVNC, ATTN: ATZQ-ATC, Fort Rucker, Alabama 36362-5265.

GCA OPERATIONS LOG

5-44. DA Form 3501-R is used to record air traffic in GCA facilities. It should be initiated at the beginning of each calendar day (0000 local time or whenever the facility begins operations for the day). Time entries shall be in UTC. The ATC chief/ATC SR SGT/PSG/ATC facility chief shall review each

completed DA Form 3501-R and sign the authentication block (block 2). If more than one form is required to log daily activities, the pages shall be numbered consecutively and stapled together. Daily totals shall be entered on the final form.

5-45. DA Form 3501-R shall be completed as follows (see figure 5-4):

- **Item 1.** Enter the name of the GCA facility.
- **Item 2.** The facility chief signature is required.
- **Item 3.** Both the date and time in the period covered shall be in UTC.
- **Item 4a and 4b.** Insert an X for the aircraft of a VFR or IFR flight plan in the applicable column.
- **Item 4c.** Enter aircraft identification or call sign (R12345).
- **Item 4d.** Enter aircraft type (UH60).
- **Item 4e.** Enter the time of radar contact in UTC.
- **Item 4f.** Enter LA [low approach], FS [full stop], TG [touch-and-go], or other type of approach.
- **Item 4g.** Enter the operating initials of the controller conducting the supervised or simulated ASR pattern portion of the approach and the initials of the controller who is signed on behind a trainee or controller on remedial training. An example of an entry for a trainee conducting an approach would be BR/CB.
- **Item 4h.** Enter the operating initials of the controller conducting the live unsupervised and non-simulated ASR pattern portion of the approach.
- **Item 4i.** Enter the operating initials of the controller conducting the supervised or simulated ASR final portion of the approach and the initials of the controller who is signed on behind a trainee or controller on remedial training. An example of an entry for a trainee conducting an approach would be BR/CB.
- **Item 4j.** Enter the operating initials of the controller conducting the live unsupervised and non-simulated ASR final portion of the approach.
- **Item 4k.** Enter the operating initials of the controller conducting the supervised or simulated final portion of the precision approach and the initials of the controller who is signed on behind a trainee or controller on remedial training. An example of an entry for a trainee conducting an approach would be BR/CB.
- **Item 4l.** Enter the operating initials of the controller conducting the live unsupervised and non-simulated final portion of the precision approach.
- **Item 4m.** Enter an X if the approach is an emergency or No Gyro simulated or live.
- **Item 4n.** Enter the time the aircraft was released to another agency, tower, or ARAC.
- **Item 4o.** Enter remarks such as MA [missed approach], the controller's initials followed by ILS MON if the controller monitored a NAVAID approach or departure (CB ILS MON) or any other control instructions.

- Add up all approaches for VFR and IFR aircraft in columns 4g through 4l at the bottom of DA Form 3501-R and write the cumulative total is written in the bottom left corner of DA Form 3501-R.

Note: For item 4g, 4i, and 4k, the rated controller will enter their initials after the controllers needing direct supervision initials, using the same format as used in DA Form 3503-R. (See paragraph 5-53)

5-46. DA Form 3501-R shall be filed daily with DA Form 3502-R and retained for a minimum of one calendar month. For example all the logs in June 2003 may not be destroyed until 1 August 2003. ARAC facilities shall use flight progress strips to record traffic movements instead of DA Form 3501-R.

GCA OPERATIONS LOG																			
For use of this form, see FM 3-04.303; the proponent agency is TRADOC																			
1. FACILITY Lost in space GCA Ft Livingroom, NA										2. FACILITY CHIEF'S SIGNATURE IMA Goon									
3. PERIOD COVERED (UTC)																			
FROM						DATE						TO							
HOUR		DATE		HOUR		DATE		HOUR		DATE		HOUR		DATE		HOUR		DATE	
0830		08 Aug 03		1630		08 Aug 03		0830		08 Aug 03		1630		08 Aug 03		0830		08 Aug 03	
4. OPERATIONS - S/S = Supervised or simulated LV = Live Unsupervised/Non-simulated																			
FLIGHT PLAN	AIRCRAFT		RADAR ID TIME (UTC) (e)	TYPE APRCH (f)	PATTERN			ASR			PAR		EMER NO GYRO (m)	RELEASE TIME (UTC) (n)	REMARKS (o)				
	IDENT (c)	TYPE (d)			S/S (g)	LV (h)	S/S (i)	LV (j)	S/S (k)	FINAL	LV (l)								
X	R12345	UH-60	0615	FS	MN/CB							MN/CB	X	0628	SMOKE IN COCKPIT				
X	R23456	AH-64	0810	LA			CB					CB		0823	MA				
X	R54321	CH-47	0924	TG			NC						X	0936	NO GYRO				
X	R53124	OH58	1005	SG	AR			AR						1022	RADAR SIMULATOR				
X	R23224	C12	1034	FS										1047	CB ILS MONITOR				
4	ENTER TOTALS IN COLUMNS AT LEFT. (TOTAL NUMBER OF IFR OPERATIONS) (TOTAL NUMBER OF VFR OPERATIONS)			TOTAL IFR	1	1	1	0	0	0	1	1	1						
				TOTAL VFR	1	1	1	1	1	1	0	0	0						

Figure 5-4. GCA Operations Log

DAILY REPORT OF AIR TRAFFIC CONTROL FACILITY

5-47. All Army ATC facilities shall use DA Form 3502-R (an electronic version may be used) to record daily activities. This form shall be initiated at the beginning of each calendar day (0000 local time or when facility operations begin for the day). Entries shall be in UTC. The logs shall be closed at midnight local for facilities operating on a 24-hour basis. Facilities operating less than 24 hours a day shall open the log when the facility opens for daily operations and close the logs when the facility officially ends operations for the day.

5-48. Only authorized Army, FAA, and ICAO abbreviations and phrase contractions shall be used for entries. The entries will describe all abnormal conditions, unusual occurrences, or items of interest. Examples of entries are equipment checks, outages or restorations, emergencies, accidents and unsafe conditions. The operating initials of the individual making the entry shall follow all entries in the remarks section of the form.

5-49. Supervisory responsibility shall be indicated in the remarks section using assigned operating initials (for example, "CB ASSUMED DUTIES AS SL"; "CB DEPARTED FACILITY, WS ASSUMED DUTIES AS CIC"). The controller responsible for the shift shall sign the appropriate signature block of the form in ink when he departs the facility. Two controllers on the same shift may be assigned supervisory responsibility at different times. When this occurs, they both shall sign in the appropriate block. They will divide the block and include the UTC for the period they were assigned supervisory responsibility (for example, I. M. Happy, 0600-0930/U. R. Wrong, 0930-1400).

5-50. The facility chief shall review each DA Form 3502-R for accuracy and sign in the authentication block by the end of the following day or next scheduled workday. This form shall be filed daily and retained for a minimum of one calendar month. (For example, June 2003 logs may be destroyed 1 August 2003.)

5-51. The following are standard entries that shall be made on the DA Form 3502-R: Any unusual occurrence shall also be annotated on the form.

- Equipment checklist completed.
- Equipment outages or returns to service. (Enter a capital E [Equipment] to the left of the time entry.)
- Tape being recorded (for example, "TAPE 3 DECK 2 IN USE").
- Initials of the person and the facility notified of events (for example, CS/WX, JD/OPS, or RH/ARAC).
- Shift change completion (for example, "SHIFT CHG CMPLT, ABOVE NOTED WR").
- Supervisor on duty; for example CB/SL or CH/CIC.
- TIME CHECK OT, annotate amount of time off (for example TIME ADJUSTED, CLOCK 35 SECONDS FAST [each shift]).
- Facility or log opening and closing. (Around-the-clock facilities shall show when the log was opened and closed. Part-time facilities shall show when the facility and logs were opened and closed.
- Opening and closing broadcast (for example "CLOSING BROADCAST CMPLT").

- Weather conditions at the airfield, heliport, or landing area; for example, WX-IFR/VFR.
- Tower visibility if different than what is reported by the official weather report.

AIR TRAFFIC CONTROL POSITION LOG

5-52. DA Form 3503-R provides a record of personnel assigned to each operating position within an ATC facility. Controllers assigned responsibility for an operating position initiate the DA Form 3503-R at the beginning of each calendar day. (This would be 0000 local time or when facility operations begin for the day). Entries shall be in UTC. Pages shall be added as necessary to complete the day. The logs shall be closed at midnight local for facilities operating on a 24-hour basis. Facilities operating less than 24 hours a day shall open the log when the facility opens for daily operations and close the logs when the facility officially ends operations for the day.

5-53. Controllers requiring direct supervision shall use their operating initials followed by a slant mark (/) and the facility-rated controller's initials. Those under direct supervision include—

- Controller trainees who are not positioned qualified.
- Controllers being evaluated for facility rating by ATCS/CTO examiners.
- Rated controllers who are not current.
- Rated controllers who are receiving remedial training.

5-54. DA Form 3503-R is filed daily with DA Form 3502-R and retained for a minimum of one calendar month. (For example all the logs in June 2003 may not be destroyed until 1 August 2003.)

5-55. Automated versions/methods may be used to track position of assignment. Automated versions/methods used to track position assignment are not excluded from minimum retention periods addressed above.

Note: When a correction is required on the DA Form 3503-R a line shall be drawn through all three blocks, then the person making the correction shall place their operating initials at the end of the line and begin again on the next row. See figure 5-5.

AIR TRAFFIC CONTROL POSITION LOG			
For use of this form, see FM 3-04.303; the proponent agency is TRADOC			
POSITION <i>LC</i>			
PERIOD COVERED (UTC)			
FROM		TO	
HOUR 0530	DATE 10 FEB 03	HOUR 1800	DATE 10 FEB 03
INITIALS	TIME ON (UTC)	TIME OFF (UTC)	
BC	0530	0845	
AJ	0845	1245	
CB	1254	CB	
CB	1245	1800	

Figure 5-5. Sample Correction Format for DA Form 3503-R

FLIGHT PROGRESS STRIPS

5-56. FAA Form 7230-7.2 (*Flight Progress Strip—Terminal-Continuous*), or FAA Form 7230-8 (*Flight Progress Strip—Terminal-Cut*) shall be filed daily, and retained for a minimum of one calendar month (for example, June 2003 logs may be destroyed 1 August 03).

5-57. As outlined in FAAO 7110.65, FAA Form 7230-7.2, or FAA Form 7230-8 shall be used to record all instrument approaches. FAA Form 7230-21 shall be used to record all flight-following movements.

5-58. If there is an advantage in doing so, tower facilities may use VFR logs or notepads instead of flight strips to record all VFR operations except flight-following movements. All other facilities, shall record IFR and VFR operations on appropriate flight strips

5-59. FAA Form 7230-21 (*Flight Progress Strip-FSS*) (NSN 7530-01-449-4244) and the flight strip holder (NSN 6605-00-485-6649, Type 5) may be ordered through the normal supply channels.

5-60. Standard ATC control information symbols shall be used, and completed strips shall be maintained in the same manner as other ATC flight strips.

5-61. Instructions for completing FAA Form 7230-21 are given below. The block numbers below correspond to the pertinent block numbers on the sample of a completed flight progress strip in figure 5-6.

- **Block 1.** Aircraft identification.

- **Block 2.** Type of aircraft and the equipment suffix used for any special equipment such as the DME transponder.
- **Block 3.** Altitude.
- **Block 4.** Beacon code.
- **Block 5.** Route or area of flight.
- **Block 6.** Radio or radar contact time in UTC.
- **Block 7.** Destination (the training area or intended landing area).
- **Block 8.** ETA at the destination in UTC.
- **Block 9.** Coordination effected (CRC, FCC, range control, and ADIZ).
- **Block 10.** Type mission (for example, NOE, NVD, and administrative).
- **Block 11.** Time of last radio contact and handoff information.
- **Block 12.** Time at reporting points.
- **Blocks 13 and 14.** Reporting points, amendments, clearances, and so forth that correspond to block 12. Blocks 13 and 14 can be changed or modified by the facility as necessary.

1. R 12345		2. UH1 T		3. 8	10. NOE	12.	13.	14.
4. 1200	5. BLUE N			11. 1345 (214.0	12. 1315	13. B-1		
6. 1300	7. R2103	8. 1345	9. Range Control		12.	13.		
FAA Form 7230-21 (4-75)					12.	13.		

Figure 5-6. Sample Completed Progress Strip

Chapter 6 Installation Facility Training Program

The ATC facility training program (FTP) provides standardization and guidance in conducting facility training. The FTP guides newly assigned personnel through an established program of instruction (POI) to become facility-rated and remain proficient. Each ATC chief/ATC SR SGT/facility chief shall develop a FTP within the established training time limits in accordance with AR 95-2, chapter 4.

PROGRAM OF INSTRUCTION

6-1. The installation FTP consists of three types of training, a FTM, four training phases, tests, and the appropriate evaluations. In addition to this training, the program shall include the knowledge and skill requirements in the FAR, Part 65. All written examinations shall be closed book. The only exception to the rule is FLIPs, charts, and supplement examinations which are open book. All examinations/answer sheets will have trainee/controllers name, date, test subject and grade posted in the lower right hand corner prior to being posted in DA Form 3479-R.

6-2. FTP's shall incorporate a training schedule that gives the trainee, trainer, and SL a clear understanding of what the trainee is expected to learn and a reasonable amount of time in which to learn it. It also gives facility supervisors a means to maintain a trainee's progression effectively through the FTP. The schedule shall prescribe—

- A timetable for position qualification at each control position to include a recommended date for PQ.
- A timeframe for each FTM chapter test.
- Those tests required before the trainee can become PQ'd at each control position.
- The recommended date for position qualification examinations.
- The recommended date of the pre-FAA/ATCS examination.
- The recommended date of the final FAA/ATCS examination.
- The recommended date of the facility rating.

6-3. Chapter tests do not have to be taken in sequence. However, trainees should begin training in the least complex control position. They may take chapter tests to become PQ as soon as their abilities indicate they are ready.

CONTENTS	
Program of Instruction	6-1
Facility Training Manual.....	6-4
Training and Proficiency Record–Air Traffic Controller	6-5
Trainee/Controller Evaluation	6-9

TYPES OF TRAINING

Qualification

6-4. Newly assigned personnel receive qualification training before they can obtain a facility rating. This training is also given to facility-rated controllers when new procedures are instituted or new ATC equipment is installed. This training shall be annotated in section III, IV, V and VI (as applicable) of DA Form 3479-R.

Proficiency

6-5. Facility-rated or PQ controllers are given proficiency training to remain current and proficient on ATC policies, procedures, and equipment. This type of training includes but is not limited to weather certification, changes to Army regulations, field manuals, handbooks, and operational procedures. Proficiency training shall be annotated in sections III, IV, V and VI (as applicable) of DA Form 3479-R.

Remedial

6-6. Remedial training shall be given only to personnel who have shown that they are no longer qualified to perform satisfactorily in a control position at which they previously qualified. This training, given to correct a demonstrated weakness, may consist of classroom instruction or additional time on the position under direct supervision, or both. The ATC chief/ATC SR SGT/ATC facility chief determines the time limits for the controllers' receiving the remedial training. This training shall be annotated in sections III, IV, and V (as applicable) of DA Form 3479-R. The reason for the remedial training and time limits shall be annotated in section VI.

TRAINING PHASES

Indoctrination

6-7. All newly assigned personnel begin the FTP with this phase. The indoctrination phase shall consist of—

- A briefing on what is expected of the trainee.
- An introduction to AR 95-2.
- Discussion of training time limits.
- Issuance of the FTM.
- A comprehensive review of chapter 1 of the FTM and a general review of the remaining chapters.
- A review of the training schedule.
- A tour of the ATC facility and other airfield facilities and, if possible, a local orientation flight.
- A certificate of grades/ATCS verification.
- A successful written or oral examination on chapter 1 of the FTM. The trainee must complete the examination before entering the next phase.

Primary Knowledge

6-8. The trainee may take the primary knowledge phase in a classroom or at the facility while assigned to a shift. This phase teaches the general subjects that the trainee needs to begin training at each operating position. A written

closed-book examination on chapters 2 through 4 of the FTM and initial weather certification completes this phase. A current flight physical and DA Form 4186 (*Medical Recommendation for Flying Duty*) stating full flying duties (FFD) approved and signed by the unit commander are required before the trainee enters the next phase.

Position Qualification

6-9. In this phase, the trainee receives hands-on training at each operating position and written or oral examinations on the FTP requirements that apply to the control procedures. The trainee is then evaluated on each operating position, and the results are recorded on DA Form 3479-1-R and section V of DA Form 3479-R (see appendix A).

6-10. Position qualification training should begin at the least complex control position and advance to the most complex. To become PQ at a control position, the trainee must complete all FTP requirements that apply to that position. He also must receive a satisfactory evaluation on DA Form 3479-1-R and, in the evaluators' comments section, a recommendation from the ATC facility chief/ATC training supervisor/shift leader that he become PQ. The ATC chief/ATC SR SGT/ATC facility chief or training supervisor shall then evaluate the trainee to determine if he is qualified. Annotate these evaluations in section V of DA Form 3479-R and, in the remarks block, state that they are recommended for PQ or are now PQ.

Note: The same individual that recommends PQ/rating shall not evaluate the trainee for PQ/rating. All personnel who recommend or rate an individual shall be rated in that facility with the exception of ATCS/CTO examiners.

Facility Rating

6-11. After the trainee is PQ at all control positions, he shall be given a pre-FAA/ATCS facility rating examination. He must also receive a satisfactory evaluation on DA Form 3479-1-R and, in the evaluators' comments section, a recommendation from the facility chief/training supervisor that he is recommended for facility rating. He shall then be given a final FAA/ATCS facility rating examination and be evaluated on all operating positions pertaining to the rating. The results shall be recorded on DA Form 3479-1-R. These evaluations shall be annotated in section V of DA Form 3479-R and in the remarks block, it shall be stated that they are recommended for facility rating or rated.

- Pre-FAA/ATCS examination. This written examination should consist of 50 to 100 questions from the FTM, AIM, FAAO 7110.65, LOA, operations letters, approach charts, FLIPs, DPs, maps, charts and associated air traffic service and weather references. The questions shall pertain only to those topics that the trainee must know to operate as a controller at the facility to which he is assigned. This examination presents the trainee with examples of the types of questions that are on the final FAA/ATCS written examination; it may also show him areas that he needs to review. If the trainee fails this examination, he shall return to classroom study and be rescheduled for the examination to be administered in approximately

one week. This failure shall be annotated in sections III, IV, and VI of DA Form 3479-R.

- Final FAA/ATCS facility rating examination. This written examination shall consist of 50 to 100 questions on topics that the trainee must know to be a controller at the facility to which he is assigned. If the trainee fails this examination, he shall return to classroom study and be rescheduled for the examination. This failure shall be annotated in sections III, IV, and VI of DA Form 3479-R.
- Facility rating evaluation. This evaluation, which is recorded on DA Form 3479-1-R, shall cover all operating positions pertaining to the rating. It should be conducted under normal traffic conditions. This DA Form 3479-1-R shall be annotated in section V of the DA Form 3479-R and retained in the record for one calendar year.

ADMINISTRATION AND MANAGEMENT TRAINING

6-12. This training prepares personnel to progress from a controller to a facility chief. Management training is an ongoing program wherein supervisors continuously train subordinates to assume supervisory positions. Upon completion of the facility training, all personnel shall receive training in facility administration and management. Administration and management training shall culminate in a written examination of at least 25 questions. As a minimum, this training shall include those subjects listed in chapter 13 of the FTM.

6-13. Failure to complete this training satisfactorily shall not be used as a reason for reclassification action. The examination serves to point out weak areas so the individual may improve his performance. The administrative management exam shall be administered within 30 days after an individual becomes facility-rated and prior to assuming the duties of CIC, SL, ATC training supervisor, or ATC facility chief. For Department of the Army civilian (DACs), the administrative management exam shall be administered no later than 30 days after the DAC becomes eligible to perform CIC or any other supervisory duties. If he receives an unsatisfactory score, he shall be administered the exam once every 30 days until he achieves a passing score. All training and test results shall be entered into sections III, IV, and VI, as appropriate, of DA Form 3479-R.

FACILITY TRAINING MANUAL

6-14. The FTM is a locally prepared publication. The ATC chief/ATC SR SGT/PSG/ATC facility chief is responsible for its preparation, content, and quality. The manual provides personnel with a logical step-by-step progression to becoming facility-rated. The quality of the FTM has a direct bearing on the effectiveness of a facility training program. FTMs shall be reviewed, rewritten, and/or updated at least annually. A memorandum will be attached to the front of each FTM with the date, statement of review or update, and the facility chief's signature. This memorandum will be created even if no changes are made.

6-15. The FTM is used for facility rating preparation and remedial and proficiency training. The manual also serves as a reference. The charts,

maps, photographs, and drawings in the FTM make the information more understandable.

6-16. At least three copies of the FTM shall be maintained at a facility: a copy for the facility reference file, one for the controller reference file, and another for controllers to sign out. Additionally, one copy shall be sent to the quality assurance office where it shall be maintained on file. The facility may maintain any number of additional copies for controller use.

6-17. Appendix C, *Detailed Outline for an Installation Facility Training Manual*, shows a detailed FTM subject outline for installation facilities. The chapters or portions of chapters in the FTM that do not apply to a particular facility may be marked “not applicable” or be used as determined by the ATC chief/ATC SR SGT/PSG/ATC facility chief. The chief may choose to include those chapters that apply to a collocated or adjacent facility to familiarize controllers with that facility. However, trainees shall not be tested for record purposes on chapters that do not apply toward a facility rating.

TRAINING AND PROFICIENCY RECORD—AIR TRAFFIC CONTROLLER

6-18. Each tactical and installation ATC facility shall maintain a complete and current DA Form 3479-R (see appendix A) for all military and civilian controllers. To accomplish this, one training folder shall be used with a divider separating the installation records from the tactical. However, duty assignment may determine which sections (installation/tactical) are in front. For example, tactical facilities may place installation sections III through VII behind the divider instead of in front. To avoid duplication, sections I and II will be combined; the record will be maintained in the front of the folder. DA Form 3479-R shall be used to document all ratings awarded and proficiency, qualification, and remedial training conducted during field exercises. A blank copy of this reproducible form is located in the back of this manual; an electronic copy may be downloaded from <http://www.usapa.army.mil/>. Table 6-1 shows the seven sections of this form.

Table 6-1. Explanation of DA Form 3479-R		
Section	Title	Entries
I	Personal Identifying Data	Assignments, certifications, and ratings.
II	Schools Attended	Names of ATC schools or courses (military and civilian) attended and date of completion. 93C AIT, 93C Basic Non-Commissioned Officer Academy (BNCOC) (Fort Rucker), Advanced Non-Commissioned Officer Academy (ANCOC) (Fort Rucker), Airborne, Air Assault, Battle Staff NCO Course, TERPS (U.S. Air Force [USAF]/FAA only), Joint Air Operations Staff (JAOS), Joint Firepower Control Course (JFCC), Joint Airspace Command and Control Course (JAC ² C), Pathfinder, Airspace Management and courses in accordance with DA Pam 611-21.

Table 6-1. Explanation of DA Form 3479-R		
Section	Title	Entries
III	Qualification, Proficiency, and Remedial Training Record	The subject of the instruction presented, the appropriate code letter (Q – qualification, P – proficiency, R – remedial), the date training was completed, total hours of instruction, and remarks.
IV	Written/Oral/Practical Test Action	The subject tested, the date that the practical test was administered, the score received, and the remarks. (All written tests will be retained until a trainee is facility-rated. Thereafter, written tests shall be kept on file for one year from the date of the test.)
V	Proficiency Checks	The operating position in which the check is conducted, the date of the check, the score or rating received, the number of hours expended on the proficiency check, the sequenced number of the evaluation (for example, 00-4 indicates the fourth evaluation of 2000), followed by recommend PQ/rating or the letters “PQ” when position-qualified, or Rated and any additional comments in the Remarks column. (DA Form 3479-1-R will be used to record proficiency checks. All evaluations of a trainee shall be kept on file until the trainee is facility-rated. Thereafter, the facility rating and all subsequent practical evaluations shall be kept on file for one year from the date of the evaluation.)
VI	Miscellaneous General Comments	Additional information pertaining to remarks in other sections, interview data, or comments that may affect the individual’s career (for example, duties not to include flying (DNIF)/FFD safe aviation via exceptional service (SAVES), training time extensions, reason(s) for remedial training, awards, or letters of commendation). Each entry shall start with a date and then the appropriate entry. The name, rank, title, and signature of the individual making the entries is required for each entry.

Table 6-1. Explanation of DA Form 3479-R

Section	Title	Entries
VII	Individual Radar Record	<p>The monthly record count of radar approaches conducted by the controller and, in the appropriate column, the type of approach and operation. This section shall be closed out the last day of each calendar year by entering the yearly total—the total to date (the total of all the previous year’s approaches). If a controller was previously rated in a radar facility, but is currently working in a tower or AIC, then enter only the date and bring forward the totals each year. Monthly entries of 0 are not necessary. If a controller has never been radar-rated, the form may be left blank. This section applies only to radar facilities; however, it must be kept for all controllers once they start radar training. Supervised or simulated (S/S) approaches are counted separately from live (LV) approaches.</p> <p>Note: S/S—Supervised approaches are approaches that require direct supervision for a controller, and simulated approaches are conducted on an ATC simulator. Live (LV) approaches are those approaches that do not require direct supervision and are not simulated approaches.</p>

6-19. DA Form 3479-R is a permanent record that serves as a comprehensive record of training, certification, qualification, proficiency, ratings, and duty assignments.

Preparation and Maintenance

6-20. The ATC chief/ATC SR SGT/ATC facility chief/ATC training supervisor at all Army ATC facilities shall maintain DA Form 3479-R on assigned or attached ATC specialists (military and civilian). A paper record on each controller shall be maintained in an area that is accessible only to authorized personnel. **No one shall remove, alter, omit, delete, or destroy any section or component of the DA Form 3479-R.** The only exception is section VII, which will be removed at the end of the year (the runs are totaled and brought forward to a new section VII and posted in the records). The ATC facility chief/training supervisor shall sign in the remarks section that they have verified that the runs brought forward are accurate. The previous year section VII will be returned to the controller after the ATC facility chief dates and signs the form.

- The record will be kept in a straight cut, 9½-inch by 11¾-inch, heavy-duty Kraft file folder (NSN 7530-00-222-3443). Each folder shall contain a label in the upper left corner (see appendix A) with the controller’s last name, first name, middle initial, and Social Security number. The folder shall be filed alphabetically by the controller’s last name. A dummy folder shall be used and labeled in accordance with AR 25-400-2. The following information shall be entered on the front cover of the file folder:

- Air Traffic Controller Individual Training Records Folder, United States Army.
- If found, the folder shall be returned to the Commander, USAAVNC, ATTN: ATZQ-ATC, Fort Rucker, Alabama 36362-5265.

These folders will contain DA Form 3479-1-R, training received, and examination results. It will also contain performance related to training and ratings and other correspondence related to training and ratings. DA Form 4186, ratings and certification through training, complete the contents.

- When a controller is transferred, the ATC chief/ATC SR SGT/PSG/ATC facility chief will close out sections III through VI of the controller's DA Form 3479-R by signing and dating them (see appendix A). The ATC chief/ATC SR SGT/PSG/ATC facility chief will verbally counsel the controller about the negative ramifications of removing or altering the contents of DA Form 3479-R while in transit to the new duty assignment. The individual will hand carry this record to the ATC chief/ATC SR SGT/PSG/ATC facility chief or his designee at his next duty assignment. The gaining unit shall inspect the record for deficiencies, annotate that deficiencies were found but are uncorrectable in section VI, and continue the record without removing previous entries/sections.
- The left inside portion of the folder shall contain sections I through VII of DA Form 3479-R. A computer disc containing the automated DA Form 3479-R may be stored on the inside portion of the folder. No other forms, records, or papers shall be retained on the left side of the folder. The right inside portion of the folder shall contain, from top to bottom, DA Forms 3479-1-R, with a divider separating tactical and installation (latest on top); all written tests (latest on top); and DA Forms 4186. A DA Form 4186 used for grounding shall be placed on top of DA Form 4186 issued by the flight surgeon to indicate a completed flight physical. The DA Form 4186 used for grounding shall be retained until the individual is returned to flight status; it is then removed from the training record.
- Only those forms and records listed in the paragraph immediately above are to be retained with the DA Form 3479-R. Such information as training time extensions, reclassification, and counseling shall not be retained with DA Form 3479-R. However, remarks of these actions shall be entered in section VI of the form.

Note: Every time a soldier reports to a new duty station, a new DA Form 4186 is required. This DA Form 4186 replaces the old form in the DA Form 3479-R.

Availability

6-21. File folders are available to the individual controller upon request. They also will be made available to—

- ATSCOM.
- Commanders.

- FAA authorities.
- Supervisors (training or shift).
- Aircraft accident and flight violation investigators.
- Systems managers and their authorized representatives.
- Military examiners who facility-rate the controller for duty.
- Other authorized individuals who request the folders in person from the record custodian or who submit written requests to system managers.

Note: Requests for files shall state the reason for the request; the intended use of the information; and the requester's name, military or civilian status, ATCS number, and duty location. Requests are approved by the ATC chief/ATC SR SGT/PSG/ATC facility chief.

Contests and Appeals

6-22. Individuals may contest (appeal) the entries on the DA Form 3479-R. The appeals shall be directed through channels to the Commander, USAAVNC, ATTN: ATZQ-ATC, Fort Rucker, Alabama 36362-5265.

Retention

6-23. These records are permanent and shall remain active while an individual is an air traffic controller. The records will be returned to the individual upon completion of reclassification actions, termination of service, and so forth.

TRAINEE/CONTROLLER EVALUATION

6-24. The DA Form 3479-1-R provides a written evaluation of an individual's training progress or job performance. It also provides a means for showing weak points that need to be corrected. Personnel responsible for the completion of DA Form 3479-1-R shall ensure the evaluation factors are standardized for each operating position within the facility.

PREPARATION

6-25. DA Form 3479-1-R is used to record trainee/controller proficiency and qualification at all control positions. The evaluator shall make the appropriate entries and sign the form. These are important forms; therefore, they must be completed properly and on time. Annotate the evaluations in section V of DA Form 3479-R and, in the remarks block state the reason the DA Form 3479-1-R was given (for example proficiency, recommended position qualification, or facility rating). Complete DA Form 3479-1. A blank copy of DA Form 3479-1-R is at the back of this manual.

- **NAME block.** Self-explanatory.
- **GRADE block.** Enter rank/civilian grade level (SGT/GS 10).
- **ATCS NUMBER block.** Self-explanatory.
- **EVALUATION NUMBER block.** The training supervisor assigns the number.
- **TYPE OF TRAINING block.** Show the type of training/evaluation conducted (qualification, proficiency, or remedial).

- **POSITION FACILITY EVALUATED block.** Self-explanatory.
- **TRAINING MONTH block.** Show the progressively numbered training month for trainee/controller. (This block does not apply to proficiency evaluations conducted for facility-rated controllers.)
- **Satisfactory (SAT), NEEDS improvement (IMPROV), and unsatisfactory (UNSAT) columns.** Using evaluation factors A through H on the form, rate the trainee's/controller's performance according to the following guidelines. Place a check in the appropriate column for items 1 through 29.
 - **SAT.** A checkmark in this column indicates that the trainee/controller is performing at a level that is satisfactory for position qualification.
 - **NEEDS IMPROVEMENT.** A checkmark in this column indicates that the trainee is performing at a level that is less than satisfactory for position qualification. However, he is at the level expected at this point in the training program. This column should be considered an extension of the SAT column. A checkmark in this column indicates satisfactory training progress.
 - **UNSAT.** A checkmark in this column indicates that the trainee/ controller is not performing at the level of competency expected at this point in the training program. Examples would be continued errors in the subject area with little or no improvement shown and failure to complete study assignments. Checkmarks in this column, though not extremely uncommon, should not be taken lightly nor considered normal. The instructor and the trainee should place additional emphasis on training in these areas.
- **TRAFFIC CONDITION block.** Self-explanatory.
- **OVERALL RATING block.** The overall rating is an indication of the trainee's progress in the training program. This rating shall be either SAT or UNSAT. The instructor considers the amount of time the trainee has been on the position and where he would expect the trainee to have progressed at this point. Unlike items 1 through 29, which are rated against a PQ level of competency, the overall rating is the objective opinion of the instructor/evaluator. His opinion is based on such factors as past experience, training time limitations, and traffic and complexity levels. A trainee/controller who has some areas marked SAT and others NEEDS IMPROVEMENT but none marked UNSAT could receive a SAT overall rating. This would indicate that the trainee/controller is progressing satisfactorily but still needs additional training and experience to reach the PQ level of competency. Any areas marked UNSAT in blocks A through H shall make the overall Rating UNSAT.
- **EVALUATOR COMMENTS block.** This block is probably the most important part of the evaluation form. The instructor should make detailed comments concerning the trainee's performance during the evaluation period, emphasizing those areas marked NEEDS IMPROVEMENT or UNSAT. The instructor should tailor his remarks specifically to the items so marked and provide examples of

situations that led to the ratings. He should be specific and honest. The instructor's comments must substantiate the ratings given for items 1 through 29 and the overall rating. He should take the time to discuss each rating in depth with the trainee. Supervisors should allow sufficient time for the instructor and trainee to accomplish this in an undisturbed environment (such as the break room or classroom). During the discussion, the instructor should also be sure to comment on the trainee's good points and accomplishments. Building a trainee's self-confidence is an integral part of the training program.

- **DATE, TYPED/PRINTED NAME AND GRADE, and SIGNATURE blocks.** All such blocks on page 2 of the form are self-explanatory.
- **CONTROLLER/TRAINEE COMMENTS block.** Supervisors and instructors should encourage trainees to comment (for example on their progress, the training program, and the instructor's technique). These comments are important, especially if the overall rating is UNSAT or the trainee disagrees with the evaluation.
- **REVIEWING AUTHORITY COMMENTS block.** The ATC chief/ATC SR SGT/PSG/ATC facility chief/training supervisor is the reviewing authority and adds the appropriate comments. Individual shall not review DA Form 3479-1-R that they have written as evaluator.

USE

6-26. A single evaluation form may be used to evaluate the performance of a trainee/controller at more than one control position. However, an evaluation form shall not be used to show two different types of training. For example, a single form shall not be used to evaluate a trainee's proficiency at one position and qualification or remedial training at another position.

6-27. DA Form 3479-1-R provides a written evaluation of a rated PQ controller's ability to perform at a position. It is also used to evaluate a trainee's progress toward becoming PQ. If his proficiency or training progress is not satisfactory, the trainee/controller must be told why and what he must do to improve. This may include study assignments, oral or written tests, or extra time on a position. The ATC chief/ATC SR SGT/PSG/ATC facility chief should use the results of trainee/controller evaluations to determine training trends, time extensions, and FTP modifications. DA Form 3479-1-R is also used to support reclassification requests.

FREQUENCY

6-28. The supervisor determines when to conduct trainee/controller evaluations. As a minimum, these evaluations shall be conducted—

- Within each 14 calendar days after a trainee begins position qualification training.
- Within each 30-calendar days for each position at which a trainee is PQ.
- Every time a trainee is PQ or facility rated.
- Before a trainee is recommended for PQ or facility rating.
- To evaluate proficiency after a loss of currency.
- To regain qualification after receiving remedial training for a demonstrated weakness while operating a control position.

Note: A DA Form 3479-1-R will be completed on or before the evaluation due date, whether or not there is traffic. The evaluation shall state the reason why a P or Q DA Form 3479-1-R could not be completed. The evaluation shall be administered the first available date that traffic is present.

LOSS OF CURRENCY

6-29. Evaluations given to assess proficiency after a loss of currency shall be administered on all control positions with direct one-on-one supervision. The evaluation shall be conducted under normal traffic conditions and last long enough to provide a reliable performance sample. It must be completed satisfactorily before the controller assumes position responsibility without supervision. The evaluation given for a loss of currency does not make the controller current for the month given. The evaluation only satisfies the proficiency requirements and allows the controller to continue working toward his currency requirements during the next 30 days without direct one-on-one supervision. Evaluations given for a loss of currency shall be administered by the ATC facility chief, ATC training supervisor, or shift leader and are retained for one year. The ATC chief or ATC SR SGT may administer the evaluation, if he is facility-rated and current in the facility. ATCS/CTO examiners for that type of facility may also administer the evaluation.

RETENTION

6-30. When the reviewing authority signs an evaluation, it shall be placed on top of written tests and other evaluations and attached to the right inside portion of DA Form 3479-R. The results of all evaluations shall be entered in section V of the controller's training record. Evaluations shall be retained until the trainee is facility-rated. After the trainee completes facility rating, all evaluations except the rating DA Form 3479-1-R shall be returned to the controller. The rating DA Form 3479-1-R shall be retained for one year.

Chapter 7

Tactical Facility Training Program

The ATC facility training program (FTP) provides standardization and guidance in conducting facility training. The FTP guides newly assigned personnel through an established POI to become facility-rated and remain proficient. Each PSG/facility chief shall develop a FTP. This FTP shall be within the established training time limits in accordance with AR 95-2, chapter 4.

PROGRAM OF INSTRUCTION

7-1. The standardized tactical FTPs (see DA Forms 3479-11-R through DA Form 3479-19R) contain minimum training requirements and

record entries that shall be completed prior to facility rating. They consist of three types of training (a facility training manual, two training phases, tests and the appropriate evaluations). All written examinations shall be closed book. The only exception to this rule is FLIPs, charts, and supplement examinations which are open book. All examinations/answer sheets will have trainee/controllers name, date, test subject, graders initials and grade posted in the lower right hand corner prior to being posted in DA Form 3479-R.

7-2. The FTP's shall incorporate a training schedule that gives the trainee, trainer, and SL a clear understanding of what the trainee is expected to learn and a reasonable amount of time in which to learn it. It also gives facility supervisors a means to maintain a trainee's progression effectively through the FTP. The schedule shall prescribe—

- A recommended completion date for Phase I.
- Actual completion date for Phase I.
- Recommended completion date for Phase II.
- The recommended date of the pre-ATCS examination.
- The actual completion date of Phase II.

7-3. Chapter tests do not have to be taken in sequence. However, trainees should begin training in the least complex control position. They may take chapter tests to become PQ as soon as their abilities indicate they are ready.

CONTENTS	
Program of Instruction	7-1
Facility Training Manual.....	7-4
Training and Proficiency Record – Air Traffic Controller	7-5
Trainee/Controller Evaluation	7-8

TYPES OF TRAINING

Qualification

7-4. Newly assigned personnel receive qualification training before they can obtain a facility rating. This training is also given to facility rated controllers when new procedures are instituted or new ATC equipment is installed. This training shall be annotated in section III, IV, V, and VI (as applicable) of DA Form 3479-R.

Proficiency

7-5. Facility-rated or PQ controllers are given proficiency training to remain current and proficient on ATC policies, procedures, and equipment. This type of training includes but is not limited to weather certification, changes to Army regulations, field manuals, handbooks, and operational procedures. Proficiency training shall be annotated in sections III, IV, V, and VI (as applicable) of DA Form 3479-R.

Remedial

7-6. Remedial training shall be given only to personnel who have shown that they are no longer qualified to perform satisfactorily in a control position at which they previously qualified. This training, given to correct a demonstrated weakness, may consist of classroom instruction or additional time on the position under direct supervision, or both. The PSG/ATC facility chief determines the time limits for the controllers' receiving the remedial training. This training shall be annotated in sections III, IV, V, and VI (as applicable) of DA Form 3479-R.

TRAINING PHASES

Phase 1 - Qualification

7-7. This phase consists of individual and team training on the installation, operation and maintenance of all equipment associated with the ATC system to which the controller will be assigned (for example, AN/TSW-7A or AN/TSQ-221).

7-8. Tasks, conditions, and standards for equipment training shall be taken from the appropriate ARTEP manual.

7-9. The unit shall determine the amount and type of A²C² training.

7-10. Controllers shall begin this training within 60 days of assignment to the platoon or within 60 days of completing a installation training program. Active duty controllers shall complete the training within three calendar months from the date they enter the program and Army National Guard/reserve component controllers, within two annual training periods.

Phase II – Position Training and Rating

7-11. This phase covers the ability of trainees to control air traffic in a tactical environment. The trainee receives hands-on training at each operating position and receives examinations on the FTP requirements that apply to the control procedures. The trainee is then evaluated on each operating position, and the results are recorded on DA Form 3479-1-R and annotated in section V of the DA Form 3479-R. (See appendix A)

7-12. To become PQ at a control position, the trainee must complete all FTP requirements that apply to that position. He must receive a satisfactory evaluation on DA Form 3479-1-R and, in the remarks block, a recommendation from the facility chief/training supervisor/SL that he become PQ. The PSG/ATC facility chief or training supervisor shall then evaluate the trainee to determine if he is qualified. After the trainee is PQ at all control positions, he shall be given a pre-FAA/ATCS facility rating examination. He also must receive a satisfactory evaluation on DA Form 3479-1-R and, in the Remarks block, a recommendation from the facility chief/training supervisor/SL that he is recommended for facility rating. An ATCS examiner shall administer the written and practical ATCS exam that covers both phases of the FTP.

Note: The same individual that recommends PQ/rating shall not evaluate the trainee for PQ/rating.

7-13. The following tasks are performed by an ATCS examiner:

- The ATCS examiner shall give an over-the-shoulder evaluation on all positions applicable to the rating using DA Form 3479-1-R.
- The examiner shall annotate the initial rating of tactically certified on the back of the controller's FAA Form 7220-1 (*Air Traffic Controller Specialist Card*) and in the controllers DA Form 3479-R section I.
- Each time the controller is deployed to provide air traffic services after the initial rating, he must be given a written or oral proficiency check for the applicable portions of the tactical FTM and complete an over-the-shoulder evaluation on all positions applicable to the rating using DA Form 3479-1-R. This proficiency check shall be recorded in sections III, IV, V, and VI of DA Form 3479-R.
- When reassigned to a new unit, the controller must complete the unit specific FTP requirements and receive an over-the-shoulder evaluation, administered by the ATCS examiner, on all positions applicable to the rating using DA Form 3479-1-R. Upon completion of the required training and evaluation, the controller will be re-certified. Duplicate rating on like tactical facilities (AN/TSW-7A – AN/TSW-7A) shall not be annotated on the controllers FAA Form 7220-1 (pink card). All required training, testing, evaluations, and remarks shall be entered in sections III, IV, V, and VI of DA Form 3479-R.
- When a controller transfers within the same unit for cross training, those like items that can transfer from FTP to FTP shall be annotated as “P” training (such as Initial Weather certification, power equipment). This does not include A²C² training (facility specific), ARTEP task, FTM tests, pre-ATCS or ATCS examinations.

Note: ATCS examiners will set training time limits for Phase II ratings after considering the time available to evaluate a controllers' performance in a tactical environment.

ADMINISTRATION AND MANAGEMENT TRAINING

7-14. This training prepares personnel to progress from a controller to a facility chief. Management training is an ongoing program, wherein supervisors continuously train subordinates to assume supervisory positions. Upon completion of the facility training, all personnel shall receive training in facility administration and management. Administration and management training shall culminate in a written examination of at least 25 questions. As a minimum, this training shall include those subjects listed in chapter 13 of the FTM.

7-15. Failure to satisfactorily complete this training shall not be used as a reason for reclassification action. The examination serves to point out weak areas so the individual may improve his performance. The administrative management exam shall be administered within 30 days after an individual becomes facility-rated and prior to assuming the duties of CIC, SL, or ATC facility chief. If he receives an unsatisfactory score, he shall be administered the exam once every 30 days until he achieves a passing score. All training and test results shall be entered into sections III, IV, and VI as appropriate of the DA Form 3479-R.

FACILITY TRAINING MANUAL

7-16. The FTM is a locally prepared publication. The PSG/ATC facility chief is responsible for its preparation, content, and quality. The manual provides personnel with a logical step-by-step progression to becoming facility-rated. The quality of the FTM has a direct bearing on the effectiveness of a facility's training program. FTMs shall be reviewed, rewritten, and/or updated at least annually. A memorandum will be attached to the front of each FTM with the date, statement of review or update, and the facility chief's signature. This memorandum will be created even if no changes are made.

7-17. The FTM is used for facility rating preparation and remedial and proficiency training. The manual also serves as a reference source. The charts, maps, photographs, and drawings in the FTM make the information more understandable.

7-18. At least three copies of the FTM shall be maintained at a facility: one copy for the facility reference file, one for the controller reference file, and one for controllers to sign out. Additionally, one copy shall be sent to their quality assurance office where it shall be maintained on file. The facility may maintain any number of additional copies for controller use.

7-19. Appendix C, *Abbreviated Outline for a Tactical Facility Training Manual*, shows an abbreviated outline for tactical facilities. The chapters or portions of chapters in the FTM that do not apply to a particular facility may be marked "not applicable" or be used as determined by the PSG/ATC facility chief. The chief may choose to include those chapters that apply to a collocated or adjacent facility to familiarize controllers with that facility. However, trainees shall not be tested for record purposes on chapters that do not apply toward a facility rating.

TRAINING AND PROFICIENCY RECORD—AIR TRAFFIC CONTROLLER

7-20. Each tactical and installation ATC facility shall maintain a complete and current DA Form 3479-R (see appendix A) for all military and civilian controllers. To accomplish this, one training folder shall be used with a divider separating the installation records from the tactical record. However, duty assignment may determine which sections (installation/tactical) are in front (for example, tactical facilities may place installation sections III thru VII behind the divider instead of in front). To avoid duplication, sections I and II will be combined; the record will be maintained in the front of the folder. Tactical facilities are not required to take DA Form 3479-R on short-term field exercises that do not exceed 30 days. However they shall take each trainee’s standardized FTP DA Form 3479-11-R through DA Form 3479-19-R to the field. Upon completion of the exercises, all training, test, and evaluations shall be annotated in the controllers DA Form 3479-R section III, IV, V, VI, and VII as appropriate. DA Form 3479-R shall be used to document all ratings awarded and proficiency, qualification, and remedial training conducted during field exercises. A blank copy of this reproducible form is located in the back of this manual, or a computer-generated copy may be downloaded from <http://www.usapa.army.mil/>. Table 7-1 shows the seven sections of this form.

Table 7-1. Explanation of DA Form 3479-R		
Section	Title	Entries
I	Personal Identifying Data	Assignments, certifications, and ratings.
II	Schools Attended	Names of ATC schools or courses (military and civilian) attended and date of completion. (93C AIT, 93C Basic Non-Commissioned Officer Academy (BNCOC) (Fort Rucker), Advanced Non-Commissioned Officer Academy (ANCOG) (Fort Rucker), Airborne, Air Assault, Battle Staff NCO Course, TERPS (U.S. Air Force [USAF]/FAA only), Joint Air Operations Staff (JAOS), Joint Firepower Control Course (JFCC), Joint Airspace Command and Control Course (JAC ² C), Pathfinder, Airspace Management and courses in accordance with DA Pam 611-21.
III	Qualification, Proficiency, and Remedial Training Record	The subject of the instruction presented, the appropriate code letter (Q – qualification, P – proficiency, R – remedial), the date training was completed, total hours of instruction, and remarks.
IV	Written/Oral/Practical Test Action	The subjected tested, the date the practical test was administered, the score received, and the remarks. (All written tests will be retained until a trainee is facility-rated. Thereafter, written tests shall be kept on file for one year from the date of the test.)

Table 7-1. Explanation of DA Form 3479-R		
V	Proficiency Checks	The operating position and facility in which the check is conducted, the date of the check, the score or rating received, the number of hours expended on the proficiency check, the sequenced number of the evaluation (for example, T00-4 indicates the fourth evaluation of 2000), "followed by recommend PQ/rating or the letters "PQ" when position-qualified, or ATCS rated, and any additional comments in the Remarks column. (DA Form 3479-1-R will be used to record proficiency checks. All evaluations of a trainee shall be kept on file until the trainee is facility-rated. Thereafter, the facility rating and all subsequent practical evaluations shall be kept on file for one year from the date of the evaluation.)
VI	Miscellaneous General Comments	Additional information pertaining to remarks in other sections, interview data, or comments that may affect the individual's career (for example, DNIF/FFD SAVES, training time extensions, reason(s) for remedial training, awards, or letters of commendation). Each entry shall start with a date and then the appropriate entry. The name, rank, title, and signature of the individual making the entries is required for each entry.
VII	Individual Radar Record	<p>The monthly record count of radar approaches conducted by the controller and, in the appropriate column, the type of approach and operation. This section shall be closed out the last day of each calendar year by entering the yearly total—the total to date (the total of all the previous year's approaches). If a controller was previously rated in a radar facility, but is currently working in a tower or AIC, then enter only the date and bring forward the totals each year. Monthly entries of 0 are not necessary. If a controller has never been radar-rated, the form may be left blank. This section applies only to radar facilities; however, it must be kept for all controllers once they start radar training. Supervised or simulated (S/S) approaches are counted separately from live (LV) approaches.</p> <p>Note: S/S—Supervised approaches are approaches that require direct supervision for a controller and simulated approaches are conducted on an ATC simulator. Live (LV) approaches are those approaches that do not require direct supervision and are not simulated approaches.</p>

7-21. DA Form 3479-R serves as a comprehensive record of training, certification, qualification, proficiency, ratings, and duty assignments.

Preparation and Maintenance

7-22. The PSG/facility chief at all Army ATC facilities shall maintain DA Form 3479-R on assigned or attached ATC specialists. A paper record on each controller shall be maintained in an area that is accessible only to authorized personnel. **No one shall remove, alter, omit, delete, or destroy any**

section or component of the DA Form 3479-R. The only exception is section VII, which will be removed under the following circumstance: At the end of the year the runs are totaled and brought forward to a new section VII and posted in the records. The PSG/ATC facility chief shall sign in the remarks section that they have verified the runs brought forward are accurate. The previous year's section VII will be returned to the controller after the ATC facility chief dates and signs the form.

- The record will be kept in a straight cut, 9 1/2- by 11 3/4-inch, heavy-duty, Kraft file folder (NSN 7530-00-222-3443). Each folder shall contain a label in the upper left corner (see appendix A) with the controller's last name, first name, middle initial, and Social Security number. The folder shall be filed alphabetically by the controller's last name. A dummy folder shall be used and labeled in accordance with AR 25-400-2. The following information shall be entered on the front cover of the file folder:
 - Air Traffic Controller Individual Training Records Folder, United States Army.
 - If found, the folder shall be returned to the Commander, USAANVC, ATTN: ATZQ-ATC, Fort Rucker, Alabama 36362-5265.

These folders will contain DA Form 3479-1-R, training received, and examination results. It will also contain performance related to training and ratings and other correspondence related to training and ratings. DA Form 4186 and grades, ratings, and certification through training complete the contents.

- When a controller is transferred, the PSG/ATC facility chief will close out sections III through VI of the controller's DA Form 3479-R by signing and dating them (see appendix A). The PSG/ATC facility chief will verbally counsel the controller about the negative ramifications of removing or altering the contents of DA Form 3479-R while in transit to the new duty assignment. The individual will hand carry this record to the PSG/ATC facility chief or his designee at his next duty assignment. The gaining unit shall inspect the record for deficiencies, annotate that deficiencies were found but are uncorrectable in section VI, and continue the record without removing previous entries/sections.
- The left inside portion of the folder shall contain sections I through VII of DA Form 3479-R. A computer disc containing the automated DA Form 3479-R may be stored on the inside portion of the folder. No other forms, records, or papers shall be retained on the left side of the folder. The right inside portion of the folder shall contain, from top to bottom, DA Forms 3479-1-R, with a divider separating tactical and installation, (latest on top); all written tests (latest on top); and DA Forms 4186. A DA Form 4186 used for grounding shall be placed on top of a DA Form 4186 issued by the flight surgeon to indicate a completed flight physical. The DA Form 4186 used for grounding shall be retained until the individual is returned to flight status; it is then removed from the training record.

- Only those forms and records listed in the paragraph immediately above are to be retained with the DA Form 3479-R. Such information as training time extensions, reclassification, and counseling shall not be retained with DA Form 3479-R. However, remarks of these actions shall be entered in section VI of the form.

Note: Every time a soldier reports to a new duty station, a new DA Form 4186 is required. This DA Form 4186 replaces the old form in the DA Form 3479-R.

Availability

7-23. File folders are available to the individual controller upon request. They also will be made available to—

- ATSCOM.
- Commanders.
- FAA authorities.
- Supervisors (training or shift).
- Aircraft accident and flight violation investigators.
- Systems managers and their authorized representatives.
- Military examiners who facility-rate the controller for duty.
- Other authorized individuals who request the folders in person from the record custodian or who submit written requests to system managers.

Note: Requests for files shall state the reason for the request; the intended use of the information; and the requester's name, military or civilian status, ATCS number, and duty location. The ATC chief/PSG/ATC facility chief approves requests.

Contests and Appeals

7-24. Individuals may contest the contents of or appeal the entries to the DA Form 3479-R. The complaints shall be directed through channels to the Commander, USAAVNC, ATTN: ATZQ-ATC, Fort Rucker, Alabama 36362-5265.

Retention

7-25. These records are permanent and shall remain active while an individual is an air traffic controller. The records will be returned to the individual upon completion of reclassification actions, termination of service, and so forth.

TRAINEE/CONTROLLER EVALUATION

7-26. The DA Form 3479-1-R provides a written evaluation of an individual's training progress or job performance. It also provides a means for showing weak points that need to be corrected. PSG/ATC facility chief responsible for the completion of DA Form 3479-1-R shall ensure the evaluation factors are standardized for each position within the facility.

PREPARATION

7-27. DA Form 3479-1-R is used to record trainee/controller proficiency and qualification at all control positions. The evaluator shall make the appropriate entries and sign the form. These are important forms; therefore, they must be completed properly and on time. The evaluations given shall be annotated in section V of DA Form 3479-R and in the remarks block state the reason the DA Form 3479-1-R was given (for example proficiency, recommended position qualification, or certification). DA Form 3479-1-R shall be filled out as explained below. A blank copy of this reproducible form is at the back of this manual.

- **NAME block.** Self-explanatory.
- **GRADE block.** Enter rank (SGT).
- **ATCS NUMBER block.** Self-explanatory.
- **EVALUATION NUMBER block.** The training supervisor assigns the number preceded by a "T" (T02-05).
- **TYPE OF TRAINING block.** Show the type of training/evaluation conducted, and the facility that the training was conducted on (for example Q, P, or R AN/TSW-7A).
- **POSITION/FACILITY EVALUATED block.** Show the position evaluated and the facility (for example LC AN/TSW-7A).
- **TRAINING MONTH block.** N/A
- **SAT, NEEDS IMPROV, and UNSAT columns.** Using evaluation factors A through H on the form, rate the trainee's/controller's performance according to the guidelines given below. Place a check mark in the appropriate column for items 1 through 29.
 - **SAT.** A check mark in this column indicates that the trainee/controller is performing at a level that is satisfactory for position qualification.
 - **NEEDS IMPROVEMENT.** A checkmark in this column indicates that the trainee is performing at a level that is less than satisfactory for position qualification. However, the trainee is at the level expected at this point in the training program. This column should be considered an extension of the SAT column. A checkmark in this column indicates satisfactory training progress.
 - **UNSAT.** A checkmark in this column indicates that the trainee/controller is not performing at the level of competency expected at this point in the training program. Examples would be continued errors in the subject area with little or no improvement shown and failure to complete study assignments. Checkmarks in this column, though not extremely uncommon, should not be taken lightly nor considered normal. The instructor and the trainee should place additional emphasis on training in these areas.
- **TRAFFIC CONDITION block.** Self-explanatory.
- **OVERALL RATING block.** The overall rating is an indication of the trainee's progress in the training program. This rating shall be either SAT or UNSAT. The instructor considers the amount of time the trainee has been on the position and where he would expect the trainee to have progressed at this point. Unlike items 1 through 29,

which are rated against a PQ level of competency, the overall rating is the objective opinion of the instructor/evaluator. The instructor's opinion is based on such factors as past experience, training time limitations, and traffic and complexity levels. A trainee/controller who has some areas marked SAT and others NEEDS IMPROVEMENT but none marked UNSAT could receive a SAT overall rating. This would indicate that the trainee/controller is progressing satisfactorily but still needs additional training and experience to reach the PQ level of competency. Any areas marked UNSAT in blocks A through H shall make the overall rating block UNSAT.

- **EVALUATOR COMMENTS block.** This block is probably the most important part of the evaluation form. The instructor should make detailed comments concerning the trainee's performance during the evaluation period, emphasizing those areas marked NEEDS IMPROVEMENT or UNSAT. The instructor should tailor remarks specifically to the items so marked and provide examples of situations that led to the ratings. The instructor should be specific and honest, and comments must substantiate the ratings given for items 1 through 29 and the overall rating. The instructor should take the time to discuss each rating in depth with the trainee. Supervisors should allow sufficient time for the instructor and trainee to accomplish this in an undisturbed environment (such as the break-room or classroom). During the discussion, the instructor should also be sure to comment on the trainee's good points and accomplishments. Building a trainee's self-confidence is an integral part of the training program.
- **DATE, TYPED/PRINTED NAME AND GRADE, and SIGNATURE blocks.** All such blocks on the reverse side of the form are self-explanatory.
- **CONTROLLER/TRAINEE COMMENTS block.** Supervisors and instructors should encourage trainees to comment (for example, on their progress, the training program, and the instructor's technique). These comments are important, especially if the overall rating is UNSAT or the trainee disagrees with the evaluation.
- **REVIEWING AUTHORITY COMMENTS block.** The PSG/ATC facility chief/training supervisor is the reviewing authority and adds the appropriate comments.

USE

7-28. A single evaluation form may be used to evaluate the performance of a trainee/controller at more than one control position. However, an evaluation form shall not be used to show two different types of training. For example, a single form shall not be used to evaluate a trainee's proficiency at one position and qualification or remedial training at another position.

7-29. DA Form 3479-1-R provides a written evaluation of a rated PQ controller's ability to perform at a position. It is also used to evaluate a trainee's progress toward becoming PQ. If his proficiency or training progress is not satisfactory, the trainee/controller must be told why and what he must do to improve. This may include study assignments, oral or written tests, or extra time on a position. The PSG/facility chief should use the results of trainee/controller evaluations to determine training trends, time

extensions, and FTP modifications. DA Form 3479-1-R is also used to support reclassification requests.

FREQUENCY

7-30. The supervisor determines when to conduct trainee/controller evaluations. As a minimum, these evaluations shall be conducted—

- Before a trainee is recommended for PQ or a facility rating.
- Every time a trainee is PQ or facility rated.
- To regain proficiency each time the facility is deployed on an ATC mission when the controller has exceeded 30 days without working traffic in that facility.
- To regain qualification after receiving remedial training for a demonstrated weakness while operating a control position.
- For a trainee, at least once every field problem, or for longer missions once every seven days.

PROFICIENCY

7-31. Evaluations given to regain proficiency shall be administered on all control positions. The evaluation shall be conducted under normal traffic conditions and last long enough to provide a reliable performance sample. It must be satisfactorily completed before the controller assumes position responsibility without supervision.

7-32. The ATCS examiner shall administer evaluations given for rated controller proficiency, when deployed on an ATC mission or FTX, if the controller has not set up or deployed and worked traffic with his/her assigned facility within the last 30 days. After at least two of the most experienced rated controllers are found to be proficient by the ATCS examiner, the remaining controllers may be evaluated for proficiency by the proficient controllers. The DA Form 3479-1-R is retained for one year.

7-33. Controllers assigned to installation facilities and concurrently assigned to a like tactical facility (7A, TTCS) are not required to receive a proficiency evaluation if they meet the currency requirements outlined in appendix H. This does not preclude the requirements to set up the tactical equipment for proficiency training at least once every 30 days. Setting up the equipment shall be recorded in section III of DA Form 3479-R as proficiency training.

Note: The proficiency evaluations do not have to be administered on the deployment or FTX site. They may be administered anywhere and anytime prior to the controller assuming ATC responsibilities without direct one-on-one supervision and within 30 days of the deployment/FTX.

RETENTION

7-34. Once signed by the reviewing authority, evaluations shall be placed on top of written tests and other evaluations and attached to the right inside portion of the DA Form 3479-R. The results of all evaluations shall be entered in section V of the controller's training record. Evaluations shall be retained until the trainee is facility-rated. After the facility rating is completed, all evaluations (except ratings on DA Form 3479-1-R) shall be

returned to the controller. The ratings on DA Form 3479-1-R shall be retained for one year.

Chapter 8 Maintenance

Federal Aviation Administration Order 6000.6, U.S. Interagency Ground Inspection governs ground inspection, certification, and the operation of military facilities used in the National Airspace System (NAS). TM 95-225 is the standard manual of flight inspection procedures. This chapter includes portions of that manual along with additional explanatory material, where applicable. The Army has one ground inspection standard that applies to all fixed and tactical ATC facilities. This guidance shall not relieve maintenance or supervisory personnel from executing procedures or emergency actions warranted by specific situations. Flight inspections are required for initial setting and commissioning of all facilities. Additional inspections are required to monitor the operating status of the facility from the user's point of view.

SECTION I – GROUND INSPECTION

CERTIFICATION RESPONSIBILITY

8-1. Certification is the quality control used by facility maintenance to ensure ATC facilities provide their advertised service. Facility maintenance independent discretionary judgment about the provision of advertised services, the need to separate profit motivations from operational decisions, and the desire to minimize liability, make the regulatory function of certification and oversight an inherently governmental function. Verification is the process by which non-Federal personnel (as defined in FAR 171 and FAAO 6700.20) perform a similar quality control function. Facility maintenance is responsible for overseeing the verification process.

8-2. Personnel with specific written certification authority and responsibility on the subject facility shall perform certification. Section II describes

CONTENTS	
Section I – Ground Inspection	8-1
Certification Responsibility.....	8-1
Certification Procedures	8-2
Section II – ATC Maintenance	
Certification Program	8-6
Program Objectives	8-7
Certification Responsibility and Authority.....	8-7
Maintenance Technician Certification.....	8-8
Theory of Operation and Performance Examinations	8-10
Theory (Concepts) Written Examinations	8-11
Section III – Records File, Forms, and Maintenance Certification	
Requirements	8-13
Records File.....	8-13
Forms	8-15
Section IV – Air Traffic Control and NAVAID Facility Standards	8-16
General.....	8-16
Environmental Control Standards for ATC and NAVAID Facilities	8-38

certification authority credentials. Personnel without certification authority may perform maintenance and logging duties. These activities shall either be confined to non-certification parameters or followed with the appropriate certification by a fully qualified system specialist.

CERTIFICATION PROCEDURES

8-3. Systems, subsystems, and service certification shall be entered in the appropriate maintenance log prior to commissioning and periodically thereafter, in accordance with applicable maintenance handbooks. Log entries for services without a maintenance log shall be placed in the associated facility maintenance log, in accordance with DA Pam 738-750. Certification shall be performed during restoration process after—

- An interruption or outage caused by or affecting a certification parameter. Recertification is not required when a facility with internal monitoring and auto-reset or operator-initiated reset returns to service, and no other action other than the reset was taken.
- The removal of certification due to system degradation.
- The maximum certification interval (PMCS and equipment alignment) has been exceeded.
- Any maintenance activity affecting a certification parameter.

8-4. Certification shall also be performed following an aircraft accident or incident when required by TM 95-225 and FAAO 8020.11b.

INSPECTION RESPONSIBILITY

8-5. Personnel responsible for ground inspection of Army ATC and NAVAID facilities can use the information in this chapter to establish criteria for determining the technical efficiency of these facilities. This guidance does not authorize agencies to assume ground inspection authority over facilities that are not now under their jurisdiction. The facility maintenance chief and the ATC chief/ATC SR SGT/PSG or their representatives are responsible for coordinating ground inspection activities. Maintenance personnel having inspection responsibility for a facility must request confirming flight inspection when safe operation of the facility is in question. Flight inspections are required when—

- Circumstances require a confirming flight inspection.
- Circumstances do not require a confirming flight inspection.

Note: Special flight inspections will be accomplished per TM 95-225, section 104.5.

VOR/DME/TACAN Inspections (Installation Facilities Only)

8-6. Circumstances requiring a confirming flight inspection include—

- Major changes in local obstructions or buildings that may affect the signal strength, coverage, or courses.
- Replacement or installation of the TAC/DME antenna or radio frequency (RF) subassemblies (excluding transmission lines) of the antenna.

- Major modernization or corrective maintenance to the counterpoise, such as extension of the counterpoise.
- Change in facility operating frequency.
- Change in output level (power) for the purpose of increasing or decreasing service volume.
- Adjustment or replacement of the VOR antennas or components (including pedestals, loops, baluns, and supporting braces).
- Installation and operation of the TACAN antenna (with no change to the VOR antenna system).
- Those activities stated in paragraph 8-7, when standard ground-tracking procedures are not used.
- Replacement or modification of the test generator, if the tolerances for ground check cannot be met.
- Installation of a modification to improve the RF spectrum for 50 kHz channel spacing, or to eliminate adjacent channel interference.

8-7. Circumstances not requiring a confirming flight inspection—

- Replacement of any or all solid-state components.
- Replacement or repair of equipment components or units.
- Complete tuning of the transmitter.
- Measurement and adjustment of all modulation levels.
- Phasing adjustments.
- Installation or relocation of the DME mast, the TACAN monitoring pole, or a remote communication outlet (RCO) antenna pole (if accomplished in accordance with current instructions).
- Replacement of the polarizer when reset to the previous setting, or readjustment of the polarizer when a portable ground polariscope is used to optimize the facility for minimum vertical polarization.
- Installation or replacement of obstruction lights or the painting of the antenna shelter.
- Replacement of the RTA-2 upper and lower bearings, spin motor, and the radome.
- Other maintenance procedures, such as refurbishment of VOR counterpoise, wood decking, and/or terneplate, provided conditions are restored to those that existed at the time of the last flight inspection (as reflected in facility records) and ground check is within ± 0.2 degrees of the reference ground check.
- Other maintenance procedures, such as any or all of the following, provided conditions are restored to those that existed at the time of the last flight inspection (as reflected in facility records).
 - Repair, alignment, or replacement of the goniometer.
 - Repair, replacement, modification, or repositioning of any fixed field detector used in facility monitoring.
 - Replacement or modification of any signal element in the monitors.
 - Adjustment or replacement of the RF transmission lines (including feedlines, stubs, positioner, and bridges, either coaxial or hybrid).

- Replacement, repair, or modification of test equipment. (For the VOR, if unable to make before and after measurements, a confirming flight inspection will not be required if the tolerances for ground check are met.)

8-8. Refer to FAAO 6820.7B and applicable equipment technical manuals, Equipment – VOR/DME and VORTAC, for ground inspection procedures.

NDB Inspections

- 8-9. Circumstances requiring a confirming flight inspection include—
- Major changes in local obstructions, building, and so forth that may affect signal strength and coverage.
 - Changes or modifications to the antenna or ground plane that may affect facility coverage.
 - Change in the antenna current to increase or decrease the service volume.
 - Frequency change.

8-10. Circumstances not requiring a confirming flight inspection. The circumstances remain unchanged as stated in the appropriate manuals.

8-11. Installation facilities refer to FAAO 6740.2 and applicable equipment technical manuals for ground inspection procedures.

8-12. Tactical facilities refer to applicable -10/-20/-30 technical manuals.

ILS Inspections of the Localizer, Glide Slope and 75 MHz Marker Beacons (Installation Facilities Only)

- 8-13. Circumstances requiring a confirming flight inspection include—
- Changes to obstructions, buildings, power lines, and so forth that may affect the radiated signal.
 - Construction, runway repairs, and so forth that were performed in the general localizer or glide slope area, if there is any doubt about how they affect facility performance.
 - Change in the facility assigned operating frequency.
 - Replacement of critical ILS components (such as RF lines and antenna components, RF bridges, electronic modulators, mechanical modulator troughs or parts, power dividers) and transmitters as complete units if they contain any of these critical components.
 - Repair or replacement of any of the localizer antennas in the radiating array.
 - Repair, replacement, or repositioning of any of the glide slope antennas in the radiating array.
 - Removal, repair, or reinstallation of any of the glide slope antennas in the radiating array.

8-14. Circumstances not requiring a confirming flight inspection include all other maintenance activities that meet the maintenance requirements of FAAO 6750.49.

8-15. Refer to FAAO 6750.49 and applicable equipment technical manuals for ground inspection procedures.

Primary and Secondary Radar Facility Inspections

8-16. Circumstances requiring a confirming flight inspection include—

- When a reported deficiency is not susceptible to exact measurement or to verification by ground measurement.
- After an aircraft accident in which the radar facility may have been involved.
- After an antenna change (ASR/PAR) or antenna tilt change (fixed tilt surveillance radars only) or when engineering judgment indicates a probable change in the antenna radiation pattern.
- After a modification or other circumstance that, in the judgment of the individual in charge, requires facility performance to be recertified.
- Anytime secondary radar directional output power is reduced below the minimum output power level or the omni to directional power ratio is increased above the level previously flight checked.

8-17. When circumstances remain unchanged, no confirming flight inspection is required as stated in the appropriate manuals.

Periodic Operational Checks of the Radar System

8-18. In addition to the flight commissioning flight inspection, periodic operational checks of the radar system will be performed by the FAA, Army flight inspection aircraft, and air traffic controllers. These checks will supplement the performance assurance obtained from observing the system during daily operations. These checks include—

- Observing identified targets under control within the sector and comparing them against data obtained during the commissioning flight inspection or against minimum performance requirements developed at the facility. These targets may be flight inspection aircraft or targets of opportunity.
- Checking the technical performance of the facility against the established performance data base of the facility.

Note: Installation facilities refer to FAAO 6310.19, ASR-9, and applicable equipment technical manuals for ground inspection procedures. Installation facilities refer to FAAO 6360.1 and applicable equipment technical manuals for ground inspection procedures. Tactical facilities refer to applicable -10/-20/-30 technical manuals.

COMMUNICATION FACILITIES INSPECTIONS

8-19. En route and terminal area communications are provided by the various types of air/ground facilities (for example, FCCs, flight service station [FSSs], and control towers). Facilities consist of air/ground transmitter and receiving equipment, recording equipment, and necessary control equipment.

8-20. Communications facilities do not require a flight inspection. All maintenance procedures of the communications facility can be accomplished and the facility returned to unrestricted operation without recourse to a flight inspection.

8-21. Installation communications facilities must meet the standards and tolerances outlined in FAAO 6470.29, FAAO 6480.6, FAAO 6670.13, and applicable technical manuals.

8-22. Tactical facilities refer to applicable -10/-20/-30 technical manuals.

Additional Requirements

8-23. Facilities should be visited frequently enough to ensure accurate and reliable operation according to the criteria established in this guidance. Each time a facility is visited, the maintenance technician responsible for the facility shall verify facility performance on the basis of one or more of the following criteria:

- Visual and aural. On every visit verify, by visual and aural observation, whether equipment is operating normally. This includes, but is not limited to, meter readings, pilot light indications, extraneous noises, and excessive heat.
- Monitoring. On scheduled visits and as required, certify whether the facility operation is satisfactory by noting local monitoring information. Monitoring may include a control line check to determine that control and remote monitor functions are satisfactory.
- Meter readings. On scheduled visits, if applicable, record meter readings and compare them with those previously recorded on station records.
- Performance standards and tolerances. On scheduled visits and as required, determine whether the facility meets the performance standards and tolerances established in this guidance, the technical manuals, or the handbooks.
- System ground check. On scheduled visits and as required, perform a ground check and compare the results with the reference ground check error curve (VOR) and/or with data obtained at the time of the last flight inspection. Evaluate these data, and determine that facility performance has not departed appreciably (beyond tolerance) from the previous system ground check recordings.
- Flight inspection. On scheduled visits or as requested, determine whether facility performance is satisfactory based on the flight inspection evaluation. Ground check data shall be recorded immediately following any flight inspection.

Note: An accident inspector may request a flight inspection on any NAVAID suspected to have been a contributing factor in an accident or a mishap.

SECTION II – ATC MAINTENANCE CERTIFICATION PROGRAM

8-24. This section specifies the procedures for implementing and maintaining a uniform certification program for U.S. Army ATC maintenance technicians. This guidance applies to DA civilians, local national (host nation) civilians, and military personnel (ATC systems and subsystems repair specialists in MOS 35D) who perform maintenance on Army-owned ATC equipment. Contractor personnel are prohibited from certifying U.S. Army NAVAIDs.

Contractor personnel may repair and verify that the NAVAIDs are operating properly, but NAVAIDs certification is an inherent governmental function.

PROGRAM OBJECTIVES

8-25. The U.S. Army ATC maintenance certification program establishes the uniform standards for measuring the technical proficiency of ATC maintenance technicians. It also ensures the technical competence of all maintenance personnel having direct responsibility for the safe operation of systems/subsystems/equipment critical to air navigation and ATC. The program establishes the procedures for documenting the technicians' proficiency, granting authority, and assigning certification responsibility.

CERTIFICATION RESPONSIBILITY AND AUTHORITY

8-26. The responsibility for the certification program is shared by the ATSCOM, the examiners (facility maintenance chiefs and group/battalion/company 35D personnel), and the various other maintenance chiefs and supervisors. The following responsibilities are theirs.

U.S. ARMY AIR TRAFFIC CONTROL ACTIVITY

8-27. Only examinations developed or approved by ATSCOM shall be used as a basis for issuing certification authority. This certification may be used only for the specified ATC system/subsystem/equipment. The ATSCOM shall—

- Provide overall direction to, and guidance on, the program.
- Identify and specify the theory and performance requirements.
- Standardize and continually evaluate and update all phases of the program.
- Develop, validate, review, and revise theory and performance examinations.
- Determine the systems to be added or deleted from the program and inform the appropriate individuals/elements.
- Print and distribute the examinations and certificates.
- Resolve comments, questions, and disputes about the examinations.
- Maintain database files containing complete verification records.
- Designate examining officials (in writing).
- Determine the acceptability of formal schools.

CERTIFIERS (FACILITY MAINTENANCE CHIEFS AND BATTALION/COMPANY 35D PERSONNEL)

8-28. Military or DA Civilians that serve as maintenance certifiers shall be designated, in writing, by the Director, ATSCOM, commanders of an ATS group, ATS/ATC battalion, and ATC companies that are not aligned with an ATS group or battalion, and exercise control of the program for the facility/battalion/company of assignment.

SITE MAINTENANCE CHIEFS, SHIFT MAINTENANCE CHIEFS, AND COMPANY/PLATOON MAINTENANCE SUPERVISORS.

8-29. These maintenance chiefs/supervisors shall—

- Maintain files containing complete technician certification and related training records on each technician.
- Provide the technician with the training materials needed to accomplish comprehensive training on the systems/subsystems/equipment.
- Request the theory and performance examinations through the examiner, from ATSCOM.
- Coordinate with the examiner about administration of the examination.
- Develop and document on-the-job training (OJT) on the site-specific systems/subsystems to support the certification program.
- Advise the commander on the status of ATS maintenance certification.
- Coordinate with the ATC facility maintenance chief for notice to airmen (NOTAM) if training is required on any in-use operational system/subsystem/equipment.
- Conduct and record the annual review on DA Form 3479-R.

8-30. The following guidelines shall be used to conduct the annual review of the technician's certification records: Ascertain that the technician has maintained the certification proficiency level and assigned only those certification responsibilities supported by valid certification authority. This input is mandatory and shall be documented.

MAINTENANCE TECHNICIAN CERTIFICATION

CERTIFICATION BASED ON FORMAL SCHOOL

8-31. Completion of an accepted course of study offered by FAA, DOD (excluding initial MOS producing schools), or contractors that meet or exceed the objectives required to certify the equipment to FAA (NAS) standards contained in FAAO 8200.1.

CERTIFICATION BASED ON PROGRAM COMPLETION

8-32. The certification program must be administered efficiently to provide qualified technicians that meet the stringent requirements for properly maintaining ATC equipment. The technician must satisfy the theory and performance requirements specified in this chapter to meet qualification requirements of the assigned position. After completing qualification requirements, the technician may be assigned the responsibility of certifying specific systems/subsystems/equipment. The flow chart in figure 7-1 depicts the ATS maintenance technician certification process, which consists of the eight steps given below.

Step 1. The technician is assigned to the facility or unit.

Step 2. The technician has prior certification.

Note. If certified on a particular system/subsystem, the maintenance chief reviews the technician's training records, evaluates him, then takes the appropriate steps. If not previously certified, continue with step 3.

Step 3. The technician enters the maintenance training program. This step includes—

- Establishing training records.
- Orientation on equipment.
- Orientation on facilities and their locations.
- Initial counseling on maintenance and shop operations.
- Statement of performance expectations.
- Orientation on safety.
- Overview of classes.
- SOP requirements.

Step 4. The technician enters a phased training program on individual systems or equipment (for example AN/FSQ-84 and AN/FPN-40). This step of the certification process consists of the following three phases.

- **Phase I.** The technician is trained on the theory of operation, system/subsystem/equipment operational characteristics, power requirements, frequency spectrum, and normal operating standards. Also covered in this phase are the required reference material, forms and records, maintenance allocation charts, PMCS and TMDE procedures and requirements, and local SOP requirements.
- **Phase II.** The technician is trained on alignment systems and subsystems, sequential and system interface alignment procedures, and TMDE requirements and settings. This training also includes reference material and local SOP requirements, forms, and records completion.
- **Phase III.** The technician is trained on system and subsystem fault localization, schematic use, maintenance allocation charts, and major and minor component installation/removal procedures. This training also includes tool requirements and usage, safety and quality control requirements, supply procedures, and reference material and local SOP requirements.

Step 5. When the technician has satisfactorily completed the three phases above, the examiner will request the examination from ATSCOM (in writing).

Step 6. The examiner administers the examination to the technician in two parts as explained below. All theory examinations are “open book.”

- Part 1. The technician completes the comprehensive written examination, which consists of questions on Phases II, III, and I.
- Part 2. The technician is given the hands-on performance examination on Phases II and III.

Step 7. The examiner grades the examination and sends it with the answer sheet to Commander, USAAVNC, ATTN: ATZQ-ATC, Fort Rucker, Alabama 36362-5265. If the technician passes the examination, ATSCOM issues the certification. If the technician fails the examination, the examiner identifies the specific areas in which the technician had problems. The technician is re-entered in the phased training program.

Step 8. The technician is now certified on the applicable system or subsystem. The flow process shown in figure 8-1 is continued when the technician encounters a new system or new equipment.

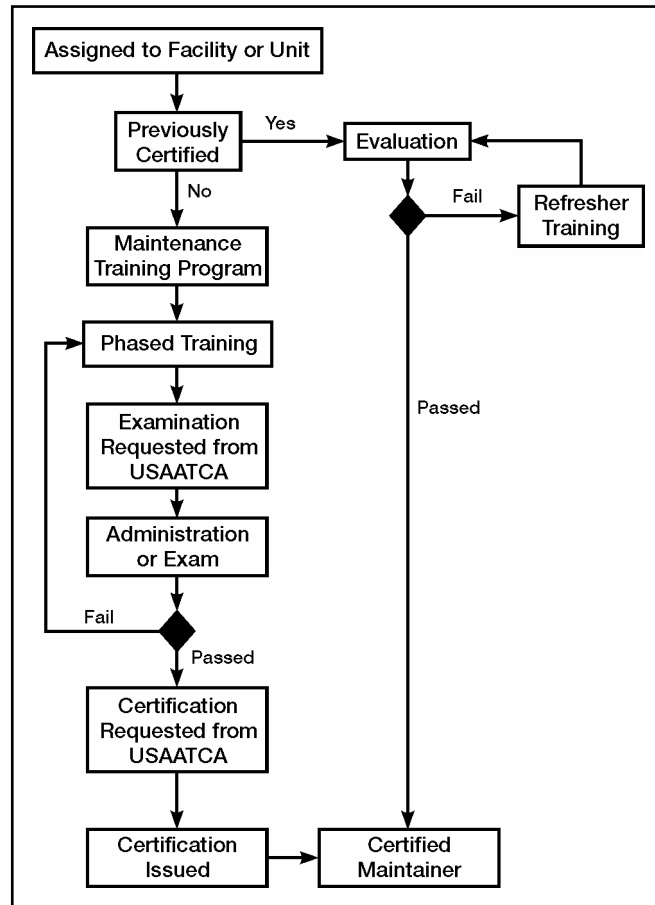

Figure 8-1. ATC Maintenance Technician Certification Process

THEORY OF OPERATION AND PERFORMANCE EXAMINATIONS

8-33. All theory and performance examinations used in the certification program are developed or validated by ATSCOM. These examinations shall be used to determine whether the examinee knows the theory and practical techniques required to perform maintenance and diagnose and correct deficiencies on ATC systems/subsystems/equipment. Comprehensive examinations are developed using technical manuals, field manuals, handbooks, manufacturer manuals, joint acceptance standards, and senior maintenance personnel. Equipment examinations are comprehensive in scope, covering not only the equipment within the system but also the auxiliary equipment considered to be part of the system.

EXAMINER PREREQUISITES

8-34. The following are prerequisites for theory and performance examiners.

8-35. The examiner shall be designated, in writing, by ATSCOM. The duties of the theory examiner consist of monitoring only he need not hold certification authority. The performance examiner must possess certification for the entire system on which he examines another technician.

THEORY (CONCEPTS) WRITTEN EXAMINATIONS

SCOPE OF THEORY EXAMINATIONS

8-36. The written examination will test the technician's understanding and knowledge of a wide range of information. The questions will cover system-oriented theory, operational characteristics, subsystems, power requirements, frequency spectrum, and normal operating standards. Some questions require both calculations and analytical reasoning.

Requests for Theory Examinations

8-37. The maintenance supervisor will send written requests for theory examinations through the examiner to ATSCOM. An examination shall not be requested unless there is a reasonable expectation that the technician will pass it. Under no circumstances shall it be used as a screening device.

Administration of Theory Examinations

8-38. When administering the theory examinations, the examiners shall—

- Understand and apply mandatory secure-handling requirements to protect program integrity.
- *Not* discuss or disclose the contents of examinations.
- Prepare an appropriate area for administering examinations and give the examinee required instructions and materials.
- Caution the examinee on the official nature of the examinations and the penalties involved for disclosure of the contents.
- Allow examinees the use of reference material (personal or supplied) during the examinations.
- Control and time examinations as prescribed, and process completed examinations as instructed.
- Store examination papers in a secure file.

Grading of Theory Examinations

8-39. The examiner will grade theory examinations; the examinations with the results will be mailed to Commander, USAAVNC, ATTN: ATZQ-ATC, Fort Rucker, Alabama 36362-5265.

8-40. If the technician fails to achieve 70 percent on the examination, the examiner will define specific weak areas and the technician shall be required to review all areas on the examination.

Security in Handling Theory Examinations

8-41. Everyone in the examination chain concerned with the certification process must maintain security in the handling of written examinations. Compromise of examinations in any form is a serious violation of the rules of conduct and discipline. Any violation shall require that the appropriate official take disciplinary action. Any person having personal knowledge of a compromise on any segment of the written examination shall advise ATSCOM immediately of the details. The security requirements of theory examinations include (but are not limited to)—

- Placement of documents in locked storage (secured with a combination lock or the equivalent).
- Accountability for all examinations after their completion.

- Refusal to discuss or transfer examination content.

PERFORMANCE EXAMINATIONS

Scope of Performance Examinations

8-42. Performance examinations are used to demonstrate a technician's proficiency. These examinations vary in length according to the complexity and scope of the system/subsystem/equipment. The use of reference material is encouraged during the examination. The examinee makes the actual adjustments, alignments, or software program changes; evaluates system performance; and corrects equipment maladjustments. The examiner observes the results and verifies the accuracy of the adjustments, alignments, or changes.

8-43. The examiner may deviate from the printed examination to ensure that the examinee has the required proficiency. The examinee should be told of any deviations before taking the examination.

8-44. If there is a published on-the-job-training (OJT) course, the performance examination may be incorporated as an integral part of OJT. When there is no published OJT course, the examination may be used as a study outline. When the examination is so used, the individual who provides OJT should not be the examiner.

8-45. The examiner may make only minor changes to the performance examination to make it compatible with the system used. Operations and questions other than those given on the performance examination may be used to assure the examinee's total system knowledge. When maintenance procedures or system configurations change, facilities shall recommend that changes be made to the examinations. Recommendations for changes to examinations shall be sent to Commander, USAAVNC, ATTN: ATZQ-ATC, Fort Rucker, Alabama 36362-5265.

Administration of Performance Examinations.

8-46. The distribution of the performance examination prior to the examination is encouraged. The technician shall be made thoroughly familiar with the examination requirements and related test equipment during OJT.

8-47. Except in instances in which two people are required to make a particular adjustment or alignment, the examinee will complete the examination unassisted.

Grading of Performance Examinations

8-48. Once the examinee has completed an operation, the examiner grades the performance. Failure of only one of certain operations constitutes failure of the entire examination.

Note: Secure handling of the performance examination is not required.

EXAMINATION REVIEW AND EVALUATION

8-49. Certification examinations are constantly reviewed and updated by ATSCOM. Examinations are combined when redundancy is discovered or

revised when found to be obsolete. Examiners may detect questions that are not correct or administer an examination that is not relevant to the system/subsystem/equipment for which the technician is being tested. In either case, examiners should include an appropriate comment with the examination and send the results to Commander, USAAVNC, ATTN: ATZQ-ATC, Fort Rucker, Alabama 36362-5265.

EXAMINATION FAILURE POLICY

8-50. If a technician requiring certification authority fails an examination, the supervisor shall return the technician to the phased training program (figure 8-1). The improvement program will be documented in the technician's official certification and related training record. The program will contain the—

- Training for the deficient areas identified.
- Recommended study material.
- Method for measuring progress.
- Time schedule for improvement program completion.
- Name of instructor(s) and method of documenting training.

8-51. If the technician fails the theory examination, he is ineligible to take the performance examination. If a technician passes the theory examination but fails the performance examination, he is not required to take another theory examination. The examiner must notify ATSCOM, in writing, of the tentative scheduled date for the new performance examination; ATSCOM will then verify the date.

8-52. The examiner will ensure that he uses a different examination each time a technician retakes the examination. A technician may not take a theory or performance examination more than three times in a 12-month period.

8-53. The ATSCOM must retain examinations, answer sheets, comments, and any other information pertaining to a failed examination for not less than two years.

SECTION III – RECORDS FILE, FORMS, AND MAINTENANCE CERTIFICATION REQUIREMENTS

8-54. This section explains the required files, forms, and records for administering the maintenance certification program. It explains the contents of the records folder and how to complete the forms, and lists the equipment requiring certification authority.

RECORDS FILE

8-55. For each technician assigned to the maintenance section who requires certification, establish and maintain an official certification and related training file. This file will be under the control of the facility maintenance chief/platoon/section. It will be kept in an area that is accessible only to authorized personnel who have been properly screened, cleared, and trained. Information in the file shall be protected according to privacy act regulations.

8-56. Each official training file shall contain documentation substantiating the technician's qualifications to possess certification authority or have responsibility on specific system/subsystems/equipment. The file shall be used as a complete historical record of the technician's certification progress. It shall contain such background data and supporting documents as reports, certification responsibility assignments/withdrawals, and granting/revocation of certification authority. This informational file shall contain documentation to support the program responsibilities assigned to the office maintaining the file.

8-57. The pertinent records will be kept in a straight cut, 9½-inch by 11¾-inch, heavy-duty Kraft file folder (NSN 7530-00-222-3443). Each folder will be maintained according to AR 25-400-2. The folders will be filed alphabetically by the technician's last name. The following information will be entered on the front cover of the file folder: Air Traffic Control Maintenance Qualification and Related Training Records Folder, United States Army. If found return to: Commander, USAAVNC, ATTN: ATZQ-ATC, Fort Rucker, Alabama 36362-5265. The folder will contain the—

- Certification and related training received.
- Performance examination sheets.
- Theory (concepts) and performance examination results.
- Grades and certifications obtained through training.
- Other correspondence related to training and certification.
- Responsibility assignment.

8-58. The left side (foldout portion) of the folder will contain DA Forms 3479-9-R and DA Form 3479-10-R. No other forms, records, or papers shall be on this portion of the folder. The right inside (foldout portion) of the folder shall contain performance examination results as well as other correspondence related to ATC maintenance training.

8-59. Those forms and records listed in paragraph 8-57 are the only materials authorized to be kept in the certification and related training records folder. Such information as reclassification, counseling, and appraisals will not be retained in this folder. However, pertinent information will be annotated in the remarks blocks on the forms.

8-60. Upon request, technicians may review the contents of their records folder. The folders are available for review to—

- ATSCOM representative.
- Commanders.
- FAA authorities.
- Supervisors (training or maintenance).
- Aircraft accident investigators.
- Mobile maintenance contact teams.
- Systems managers and their authorized representatives.
- Examiners who administer theory (concepts) and performance examinations.

8-61. When a technician is reassigned to another maintenance facility/shop, the losing organization shall note the effective reassignment date and location (if known) on his DA Form 3479-9-R. The ATC facility retains the

active paper records until that individual transfers. These paper records are transferred with the military personnel records jacket or civilian personnel folder, as appropriate. Automated management information at the primary location is retained until no longer needed for current operations. AR 5-400-2 explains record retention and disposal procedures.

8-62. When civilian and military personnel retire or separate from federal service, their records are retired. Civilian personnel records are sent to the National Personnel Records Center, 111 Winnegbago Street, St Louis, Missouri 63118; military personnel records are sent to the U.S. Army Personnel Center and U.S. Army Reserve Components Personnel and Administration Center, 9700 Page Boulevard, St. Louis, Missouri 63132. The records are retained for 115 years after the individual's date of birth. If the date of birth cannot be ascertained, the records are retained for 60 years after the date of the earliest document in the folder.

FORMS

8-63. The ATC chief/ATC SR SGT/PSG/facility maintenance chief/company maintenance chief at all Army ATC facilities and tactical units will maintain the special forms associated with the ATC maintenance personnel certification program. The chief will maintain DA Forms 3479-9-R and DA Form 3479-10-R on each assigned or attached technician (military and civilian) (see chapter 5). Blank copies of these reproducible forms are at the back of this manual.

EQUIPMENT CERTIFICATION

8-64. Table 8-1 lists ATC equipment that requires certification. A technician authorized to make such determinations must perform equipment certification. ATC equipment is unusable until certified or authorized by the commander.

<i>Name</i>	<i>Nomenclature</i>
ATC landing control system	AN/TSQ-71B
Radar set	AN/TPN-18A
Radar set	AN/TPN-18
Interrogator set	AN/TPX-44
Air traffic navigation, integration and coordination system	AN/TPN-31
Tower systems	AN/TSW-7A & C, AN/TSQ-70A, AN/MSQ-135
Tactical terminal control system	AN/TSQ-198
Tactical airspace integration systems	AN/TSQ-221, AN/TSC-61B
ATS air to ground communications	Tactical radio equipment
Radio beacon set	AN/TRN-30V(1)&(2)
Radar system	AN/FSQ-84
Radar set	AN/FPN-40

Table 8-1. Equipment Certification Listing	
Name	Nomenclature
Interrogator set	AN/TPX-41
Radar system	AN/FPN-67
Radar system	AN/FPN-66
Radar system	ASR-8/9
Digital bright radar indicator tower equipment	DBRITE
VHF omnidirectional range (VOR)	AN/FRN-41(V)
Instrument landing system	Localizer, glideslope, markers
Non-directional beacon systems	NDB
Automation systems	Automated Radar Terminal System II (ARTS II), IIA, TPX-42, PIDP, flight data entry and printout equipment (FDIO)
Analog video mapping systems	AN/GPA-131, FA8970
Tactical air navigation systems	TACAN
ATIS systems	ATIS
Distance measuring equipment	DME
ATS air-to-ground communications	Voice switches, RCE, radios
Recorders	DVRS

SECTION IV – AIR TRAFFIC CONTROL AND NAVAID FACILITY STANDARDS

8-65. This section provides guidance for the standardization of Army ATC and NAVAID facilities at AAFs and AHPs. Tactical facilities shall refer to applicable -10/-20/-30 technical manuals for installation and operational characteristics of ATS equipment. This section is intended to provide the user with information on current, standard ATC/NAVAID structures and equipment. References to specific configurations and quantities of equipment have been deleted. Information of this nature will be gathered on a case-by-case basis during ATC/NAVAID requirements surveys and configuration audits. This chapter includes sections on visual air navigation facilities, installation flight-following facilities, physical security, and environmental control of ATC/NAVAID facilities.

8-66. The major consideration in achieving this purpose is the installation of standard equipment at all ATC and NAVAID facilities in preplanned configurations.

GENERAL

8-67. This section provides the standards for planning new facilities or improving existing ones and applies to all active Army commands, Army National Guard (ARNG), and United States Army Reserve (USAR) units having requirements for installation ATC/NAVAID facilities.

- AR 95-2 sets guidance for establishing, relocating, altering, and terminating these facilities.

- UFC 3-260-01 provides guidance to assure that AAF/AHP facilities are properly planned and constructed.
- TM 95-226 sets terminal instrument approach procedures to be used with all NAVAID planning.
- TM 5-811-5 provides guidance and criteria for planning and building Army aviation lighting facilities.
- This field manual specifies operational procedures for ATC/NAVAID facilities.
- FM 11-486-23 provides engineering guidance for ATC/NAVAID facilities.

Engineering Installation Standards

8-68. Equipment configuration and installation standards for ATC/NAVAID facilities are contained in FM 11-486-23 and appropriate standard engineering installation packages (SEIPs). SEIPs contain standard design criteria, technical data, and guidance for planning and engineering installation and preparing final detailed engineering installation packages (EIPs). When SEIPs apply, they will be used for installation of ATC/NAVAID facilities.

8-69. Equipment configuration and installation standards are contained in appropriate U.S. Army Information Systems Command (USAISC) SEIP for ATC/NAVAID facilities. EIPs are technical documents that translate validated ATC/NAVAID requirements into final engineering packages and are tailored to the individual sites.

8-70. The ATSCOM shall review all ATC/NAVAID SEIPs or EIPs and changes thereto to assure adherence to findings of ATC requirement surveys, established ATC operational requirements, and equipment configurations. The ATSCOM has final authority on matters that affect ATC operations and configuration.

8-71. Installation integrity of ATC/NAVAID facility layout and equipment configuration of AAF or AHP is maintained through a configuration management (CM) program. Director, ATSCOM will publish CM policies and procedures to be applied to ATC/NAVAID systems.

8-72. The human engineering factors of military standard (MIL-STD) 1427B, including voice levels and environmental control of air, shall be applied to the facilities described in this chapter. Additional criteria are also included in this chapter pertaining to environmental factors/controls to be applied to ATC/NAVAID facilities.

8-73. All ATC/NAVAID facilities on or near an Army installation are required to implement the physical security provisions of AR 190-51 to prevent or reduce loss or damage from theft, espionage, sabotage, and other criminal or disruptive activities.

Application

8-74. ATC/NAVAID facilities must be upgraded and modernized per AR 95-2. An ATC/NAVAID requirements survey is conducted to analyze and evaluate operational requirements; decide configuration of equipment; and recommend installation termination, alteration, or relocation of ATC/NAVAID facilities

required to best support local aviation missions. The engineering site survey will confirm or determine new site location.

8-75. Existing structures (structures built before the publication date of this publication) are exempt from these standards if they meet the ATC operational needs and Office, Chief of Engineer (OCE) requirement for safety, and conform to the minimum environmental control system criteria specified in appropriate sections of this chapter. When practical and cost effective, existing structures shall comply with the provisions of this chapter. Those structures that must be replaced (cannot be economically rehabilitated) will have operational requirements validated under AR 95-2.

8-76. Continued use of existing structures or equipment is determined on a case-by-case basis with consideration for the following:

- Age and condition of the existing equipment and materials.
- Suitability, maintainability, supportability, and reliability (safety) for continued use.
- Cost of replacement and funding.
- Operational requirements for the AAF or AHP in connection with functional requirements of the equipment.
- Availability of new equipment and materials.

Backup Power System Requirements

8-77. Backup power systems in support of ATC facilities are a critical requirement for assuring continuous, reliable operation of these facilities. To prevent serious ATC facility outages (because of primary power interruptions), all ATC facilities (such as Army radar approach control [ARAC], ATC towers, ground-controlled approach [GCA], and those NAVAID facilities) that are published for instrument flight rules (IFR) use shall require backup power. Those facilities not published for IFR use may qualify if located in a geographical area considered sensitive to national security or having a history of poor climatic conditions and/or excessive power outages. Training and advisory facilities under certain conditions may also qualify. The use of uninterrupted power supplies (UPS) is recommended to provide uninterrupted power to equipment during the transfer from primary to backup power sources. Additionally, UPS has filtering networks that reduce the risk for equipment damage as the result of lightning strikes or power surges. The decision to provide backup power for facilities not published for IFR use shall be made on a case-by-case basis and determined during the ATSCOM requirements survey.

8-78. Backup engine generator facilities requires a fuel storage tank with adequate capacity for sustained backup power operation depending on mission requirements and/or availability and dependability of primary power. The average diesel generator consumes fuel at the approximate rate of one gallon per hour for each 10 kilowatt (kw) of generated power. Maximum time required for the generator to assume full load when primary power fails is 15 seconds. Minimum shutdown time for the generator when primary power is restored is 30 minutes.

8-79. Reliable operation of ATC facilities depends on the communications equipment room environmental design. Additional requirements, including

backup exhaust systems and environmental control guidance are specified later in this chapter.

8-80. Commissioned NAVAID facilities (non-directional beacon [NDB], instrument landing system [ILS], and terminal VHF omnidirectional range [TVOR]) shall be monitored using equipment specified. NAVAID facilities shall be monitored in accordance with this field manual.

8-81. Voice recording of ATC facilities is specified in appropriate sections of this field manual. The order of recording priority shall be in accordance with this field manual.

8-82. Grounding, bonding, and shielding techniques, including lightning protection of ATC/NAVAID facilities, shall be done in accordance with FM 11-487-4 and MIL-STD-188-124.

8-83. Obstruction lighting for ATC/NAVAID facilities shall be designed in accordance with TM 5-811-5 and current edition of FAA advisory circular 70/7460-1.

8-84. Requests for waivers to the criteria contained in this chapter must be sent through command channels to Commander, USAAVNC, ATTN: ATZQ-ATC, Fort Rucker, Alabama 36362-5265 for approval.

8-85. Proposed new facilities that violate UFC 3-260-01 require a waiver in accordance with AR 95-2 before the project is approved.

ARMY RADAR APPROACH CONTROL

8-86. An Army radar approach control (ARAC) is an ATC facility, located at a U.S. Army installation that uses surveillance radar (normally collocated with precision approach radar [PAR]) and air/ground communications equipment. ARAC facilities offer approach control services to aircraft arriving, departing, or transiting the airspace controlled by the facility. Service is available to both civil and military airports located within approach control airspace.

Special Provisions

8-87. A remote communications facility (paragraph 8-116) is supplied to reduce radio interference.

Equipment Guidance

8-88. Table 8-2 lists standard equipment and systems used in ARAC facilities.

8-89. The order of priority of channels for voice recording is contained in this field manual. In addition to position recording channels, enough channels should be available for discrete frequency recording of emergency and primary frequencies. ARAC facilities require, as a minimum, a 48-channel recorder.

8-90. The ARAC facility is the primary monitor location for NAVAID facilities.

Structural Standard

8-91. Standard drawings have not been made by the OCE because of differences in structural layout at many ARAC facilities. As a minimum, the following should be included when considering design of an ARAC facility:

- Operations (IFR) room.
- Equipment room.
- Ready room.
- Maintenance shop and supply room.
- Offices for chief of maintenance and chief of operations.
- Training room.
- Locker room.
- Latrine.

8-92. Design and layout of an ARAC structure should also include a maximum human engineering effort. ARAC facilities planned for future installations will make the greatest use of the structure drawings of present ARAC facilities.

Table 8-2. Major Equipment (ARAC)	
<i>Function</i>	<i>Type</i>
Airport surveillance radar	ASR
ATC beacon interrogator	Secondary radar
Automatic radar terminal system	SHAPE Technical Center Adaptable Radar Simulator (STARS)
Video mapper	
Flight data entry and printout equipment	FDIO
*Precision approach radar	Installation PAR (FBPAR)
Communications control system	AN/FSC-92 or Enhanced Tower Voice Switch (ETVS)
Console, ARAC modular	FAA type
Recorder reproducer	DVRS, 48 channel
Wind speed and direction indicator	FMQ-13
Receiver-transmitter radio	Single-Channel Ground and Airborne Radio System (SINCGARS)
UHF/VHF/AM transceiver B/U	AN/GRC-171/211
VHF/AM transmitter set	GRT/or CM200
UHF/AM transmitter set	GRT/or CM200
VHF/AM receiver	GRR/or CM200
UHF/AM receiver	GRR/or CM200
Modems	Interfacility data
Digital altimeter indicator system	As directed by site survey
Weather information display system	As directed by site survey

Table 8-2. Major Equipment (ARAC)	
<i>Function</i>	<i>Type</i>
Notes: When located on the same airfield, PAR scopes are collocated with the ARAC scopes.	

8-93. The communications equipment room environmental conditions shall be 730 ± 2 degrees Fahrenheit dry bulb for summer and winter with relative humidity (RH) 450 ± 5 percent. Thermostats shall be set to 730, humidistat to 45 percent.

8-94. Positive space pressure is required to reduce air infiltration.

8-95. Operational areas shall be designed to make sure sound levels will not exceed MIL STD-1472D.

Electrical Power Standards

8-96. Minimum needs for full load operation are as follows:

- Power: 60 kilowatt (does not include power for environmental control).
- Voltage: 120/208, ± 10 percent, 3 phase, 5 wire.
- Frequency: 60 hertz (Hz) ± 5 percent.

8-97. The ARAC facility, including the ARAC operations and communications equipment, lights and their independent environmental control systems, must have backup power with automatic start and load transfer capability if the primary source fails.

ARMY ATC TOWERS

8-98. ATC towers are terminal facilities that, through the use of air and ground communications, visual signaling, and other devices, give ATC service to airborne and surface aircraft operating in the vicinity of an AAF or AHP.

8-99. Towers normally have three functional positions: ground control, local control, and flight data. In some cases, a supervisory position may be necessary.

8-100. When space permits and where applicable, towers may also have the GCA facility located within the tower structure.

8-101. To accommodate the various ATC functions described above and maintain reasonable flexibility to meet mission needs efficiently and economically, two types of ATC tower structures have been accepted as standard by the ATSCOM.

- Type A (High Density). This tower is a permanent structure used primarily at those locations where the mission needs all the functional positions listed above, including GCA.
- Type B (Low Density). This tower is a permanent structure primarily used at those locations where the mission is less than Type A (for example no GCA).

8-102. Both towers will have a 20-foot by 20-foot cab and finished floors for a latrine/break area and a mechanical room. The equipment room and GCA, if

required, may be in a separate collocated building. This and the height of the tower will be determined by a requirement survey.

Special Provisions

8-103. Remote communications facility (paragraph 8-116) can be supplied with towers. This depends on frequency compatibility, which is decided after an electromagnetic compatibility (EMC) study has been done. The decision to remote receivers, transmitters, or both will be determined at that time.

Equipment Guidance/Facility Specification

8-104. Table 8-3 is a list of the standard equipment used in Type A and Type B towers.

8-105. The order of priority of channels for voice recording is contained in this field manual. Besides position recording channels, there should be enough channels for discrete frequency recording of emergency and primary frequencies.

Table 8-3. Major Equipment (Type A and Type B Towers)	
<i>Function</i>	<i>Type</i>
Receiver-transmitter radio	SINCGARS
UHF/VHF/AM transceiver B/U	AN/GRC-171/211 or equivalent
VHF/AM transmitter set	GRT/or CM200
UHF/AM transmitter set	GRT/or CM200
VHF/AM receiver	GRR/or CM200
UHF/AM receiver	GRR/or CM200
Communications control system	AN/FSC-92 or ETVS or STVS
Recorder/reproducer	DVRS, 16 or 48 channel
Wind speed and direction indicator	FMQ-13
Digital altimeter indicator system	As directed by site survey
Weather information display system	As directed by site survey

8-106. The facility weather information equipment is operated by the U.S. Air Force weather station. The recommended equipment is a telewriter or a closed circuit television system. Standard Army ATC equipment has not been chosen at this time. Purchase, equipment type, and maintenance is a post responsibility.

8-107. In the absence of an ARAC facility, NAVAID facilities shall be monitored in the control tower cab.

8-108. The radio communications equipment for the crash rescue net will be interfaced with the ATC communication system. Purchase, equipment type, and maintenance of crash net equipment is a post responsibility.

8-109. A standard key system will be part of the new ATC communication system (STVS/ETVS) when it is installed.

Structural Standards

8-110. Standard plans, including specifications, have been prepared by OCE. These plans generally require site adaptation by the local district or facility engineer office before building at an approved site. Copies of the design drawings listed below can be acquired as follows:

Table 8-4. Design Drawings		
DRAWING NUMBER	APPLICATION	CODE
DEF 86-06-08	U.S. Army Standard ATC Tower. Type A (I)	COE
DEF 86-06-01	U.S. Army Standard ATC Tower. Type B (II)	COE

8-111. The communications equipment room (including GCA room) design environmental conditions for Type A and Type B towers shall be 75 ± 30 degrees Fahrenheit dry bulb for summer and winter with relative humidity less than 50 percent. Thermostats shall be set to the dry-bulb temperature that is currently recommended based on considerations involving energy conservation and economics. Thermostats setting for summer cooling shall be 78 to 80 degrees Fahrenheit; winter heating, 65 to 68 degrees Fahrenheit.

8-112. Positive space pressure is necessary to decrease air infiltration.

8-113. Operational areas (including the GCA room) shall be designed to make sure sound levels will not exceed provisions of MIL-STD-1472B. To enhance safety of flight, tower cabs must be designed to decrease the high ambient noise generated on AAFs and AHPs, to achieve 98 percent sentence intelligibility with normal noise communication. Maximum ambient cab voice level should approximate 55 decibel (dB), but it should not exceed 60 decibel (dB).

Electrical Power Standards

8-114. Minimum needs for full load operations (power for environmental control not included) are as follows:

Table 8-5. Power Standards			
Type Tower	Power	Voltage	Frequency
A & B	15 kw	120/208, $\pm 10\%$, 3 phase, 5 wire or 120/240, $\pm 10\%$, 1 phase, 4 wire	50 or 60 Hz $\pm 5\%$

8-115. The control tower facilities, including the operations and communications equipment, GCA room, lights, and environmental control systems require backup power with automatic start and load transfer capability.

REMOTE COMMUNICATIONS FACILITY

8-116. A remote communications facility includes an equipment building with associated antenna platform(s). The ground radio equipment used for communications between air traffic controller and aircraft is installed in the building. The remote communications facility can either be a separate transmitter site, receiver site, or both. Transmitter and receiver sites are

located a minimum of 1/4 mile to 1 mile apart to reduce or eliminate mutual interference. UHF and VHF multi-couplers and vertically stacked antennas are used to enhance frequency isolation and reduce total number of antennas needed.

Special Provisions

8-117. USAISC (or an appropriate engineering agency) will conduct a study of the EMC to decide adequate separation of transmitting antennas, from each other and from receiving antennas. Location and height of antenna masts should not violate airfield obstruction clearance criteria of TM 5-803-4.

Equipment Guidance (Facility Specifications)

8-118. Table 8-6 lists standard equipment used in remote communications facilities.

Table 8-6. Standard Equipment	
<i>FUNCTION</i>	<i>TYPE</i>
VHF/AM transmitter set*	GRT/or CM200
UHF/AM transmitter set*	GRT/or CM200
UHF transmitter**	GRT/or CM200
VHF transmitter**	GRT/or CM200
VHF/AM receiver	GRR/or CM200
UHF/AM receiver	GRR/or CM200
Notes:	
*These items include 50-watt amplifiers and require special justification.	
**These items require detailed justification for power output of greater than 10 watts.	

Structural Standards

8-119. OCE made standard design drawing 38-04-34, including specifications. These plans generally require the local district or facility engineer office to adjust the site before it is constructed, at an approved site.

8-120. The communications equipment room design environmental conditions shall be 75 ± 3 degrees Fahrenheit dry bulb for summer and winter with relative humidity less than 50 percent. Thermostats shall be set to the dry-bulb temperature that is currently recommended based on considerations involving energy conservation and economics. Thermostat setting for summer cooling shall be 78 to 80 degrees Fahrenheit; winter heating, 65 to 68 degrees Fahrenheit. Positive space pressure is necessary to decrease air infiltration.

8-121. As a backup to the environmental control system, a thermostatically controlled roof-mounted exhaust unit must be supplied. A motorized damper shall be slaved to the exhaust unit control, to control airflow through a filtered, side-wall return-air inlet.

INSTRUMENT LANDING SYSTEM

8-122. The ILS facility consists of a precision, three-element system designed to supply aircraft with alignment, descent, and range data during approach to the runway under adverse weather conditions and poor visibility. The ILS uses solid-state transmitters that send signals through a directional localizer (course), glideslope (rate of descent), marker beacons (approach fix and range) system, and associated monitor equipment.

Equipment Guidance

8-123. Table 8-7 lists the Mark 20 ILS system and its subsystems.

Table 8-7. Major Equipment – ILS	
<i>FUNCTION</i>	<i>TYPE</i>
Instrument Landing System	Mark 20
Note: There is not any standard ILS system in the U.S. Army inventory. The FAA standard Mark 20 ILS series equipment is recommended for use at AAFs.	

Structural Standards

8-124. The ILS shelters are environmentally controlled and form an integral part of the ILS facility.

Electrical Power Standards

8-125. The localizer and glideslope facility, including the environmental control system, needs backup power with automatic start and load transfer capability in the event the primary power source fails.

8-126. Backup power for the marker beacons is part of the system and will be supplied by a 24-volt battery capable of 165 ampere-hours, sufficient for continuous operation for one week with transmitter output of 2.5 watts. This does not include exhaust blower or heater.

GROUND-CONTROLLED APPROACH

8-127. The ground-controlled approach (GCA) is a radar approach system operated from the ground by ATC personnel transmitting instructions to the pilot by radio. The approach may be conducted with airport surveillance radar (ASR), precision approach radar (PAR), or a combination of both.

Equipment Guidance

8-128. Table 8-8 lists standard equipment and (or) systems used in a GCA facility.

Table 8-8. Major Equipment – GCA	
<i>Function</i>	<i>Type</i>
Radar system	AN/FSQ-84
Radar set	AN/FPN-40
Simulator, GP, radar target	OH-36/GPN
Radar system	FBPAR
<p>Note: The AN/FSQ-84 and AN/FPN-40 will be replaced by the FBPAR, which comes with a built in simulator. Communication console (ETVS) and meteorological display console are also included. UHF, VHF, and VHF/FM radios are collocated with the control tower radios and are the same as those listed in table 8-2.</p>	

Structural Standards

8-129. The radar receiver/transmitter group (R/T) is weatherproof and does not need a shelter. The interrogator and demultiplex equipment are housed in a modified shelter. Layout of a concrete R/T group base and shelter base will be found in FM 11-486-23. GCA indicators are installed in the radar room.

8-130. The shelter is environmentally equipped with an exhaust blower and two thermostatically controlled 1,500-watt electric heaters. A removable panel is supplied for a wall-mounted air conditioner as stated by the requirements survey.

Electrical Power Standards

8-131. Minimum requirements for full-load operation are as follows:

Table 8-9. Electrical Power Standards			
<i>FACILITY</i>	<i>POWER</i>	<i>VOLTAGE</i>	<i>FREQUENCY</i>
Indicator site	2 kw*	120/240, ± 10%, 1 phase, 4 wire	50 or 60 Hz ± 5%
Receiver-Transmitter site	9 kw**	120/240, ± 10%, 1 phase, 4 wire	50 or 60 Hz ± 5%
<p>Notes: *Does not include power requirements for environmental control. **Includes 4 kw for S-70/G shelter environmental equipment and interrogator group.</p>			

8-132. The input power requires the following regulation, which generally needs an external voltage regulator and separate low-pass filter for effective suppression of ripple voltage.

Table 8-10. Power Conditioning Requirements		
<i>Voltage Regulation</i>	<i>Ripple Voltage</i>	<i>Harmonics</i>
+/- 3 volts	Maximum response time, 100 milliseconds	Maximum 3%

8-133. If separate power sources are used to supply the system indicator site and receiver-transmitter site, the power sources need not be synchronized.

8-134. The GCA facility, including the radar room, lights, and environmental control systems must have backup power with automatic start and load transfer capability if primary power fails.

TERMINAL VHF OMNIDIRECTIONAL-RANGE

8-135. A terminal VHF omnidirectional-range (TVOR) facility is a ground-based electronic NAVAID transmitting VHF navigation signals, 360 degrees in azimuth, oriented from magnetic north. The facility is used for air navigation. The TVOR periodically identifies itself by Morse code and may have an additional voice ID feature. Voice feature may be used by ATC for transmitting routine information to pilots by way of an automatic terminal information service (ATIS) recorder.

8-136. The ATIS system (not part of the TVOR facility) is physically located in the control tower equipment room with a remote control unit in the control tower cab. Connection to the TVOR or a discrete transmitter is by telephone lines.

Equipment Guidance

8-137. Table 8-11 lists standard equipment and (or) system.

Table 8-11. Major Equipment – TVOR	
<i>Function</i>	<i>Type</i>
TVOR	AN/FRN-41(V)1 AN/FRN-41(V)2 AN/FRN-41(V)T1
ATIS	AN/GSH-45
<p>Notes: The (V)1 configuration is complete with 21-foot shelter (S-597/FRN-41). The (V)2 configuration is the same as (V)1, less the shelter. The AN/FRN-41(V)T1 is a trainer configuration, which uses all of the radio transmitting set AN/FRN-41(V) except for antenna AN-3323/FRN-41 and radio frequency detector DT-603/FRN-41.</p> <p>The ATIS is located at designated control towers with voice transmission by way of the TVOR facility. A TVOR is not required for an ATIS; it can have a stand-alone transmitter.</p>	

Structural Standards

8-138. The TVOR transmitter group is supplied with a 21-foot shelter. Support construction consists mainly of a concrete base to support the shelter. The local district or facility engineers will help in design and construction of the TVOR support base.

8-139. Each shelterized TVOR comes complete with an environmental control unit. A backup environmental system is not supplied.

8-140. The TVOR shelter design environmental conditions for existing buildings shall be 75 ± 3 degrees Fahrenheit dry bulb for summer and winter with relative humidity less the 50 percent. Thermostats shall be set to the

dry-bulb temperature that is currently recommended based on considerations involving energy conservation and economics. Summer cooling shall be 78 to 80 degrees Fahrenheit; winter heating, 65 to 68 degrees Fahrenheit.

Electrical Power Standards

8-141. Minimum requirements for full-load operation are as follows:

Table 8-12. Electrical Power Standards			
<i>Facility</i>	<i>Power</i>	<i>Voltage</i>	<i>Frequency</i>
TVOR	10 kw	120/240, +/- 10%, 1 phase, 4 wire	50 or 60 Hz ± 5%

8-142. The TVOR facility, including lights and the environmental control, needs backup power with automatic start and load transfer capability if the primary power source fails.

NONDIRECTIONAL BEACON

General Provisions

8-143. The nondirectional beacon (NDB) facility transmits a nondirectional signal whereby the pilot of a suitably equipped aircraft can determine the bearing to or from the facility. The facility operates in the frequency range of 200 to 535.5 kilohertz (kHz) and transmits a continuous carrier with 1020 Hertz modulation keyed to give ID.

Equipment Guidance

8-144. Table 8-13 is a list of standard equipment used at NDB facilities.

Table 8-13. Major Equipment – NDB	
<i>Function</i>	<i>Type</i>
Nondirectional beacon	FA-9782
Antenna tuning unit	FA-9782
Monitor receiver	R-2176/FRN
Shelter	FAA Mark 1D or FAA-E-2221B equal

Structural Standards

8-145. FAA design shelter, type Mark 1D marker beacon transportable shelter or equal, will be used as the NDB shelter. Shelter specifications are in FAA-E-221B.

8-146. The environmental control system will consist of a filtered power ventilation system with thermostatic control.

Electrical Power Standards

8-147. Minimum requirements for full-load operation are as follows:

Table 8-14. Electrical Power Standards			
<i>Facility</i>	<i>Power</i>	<i>Voltage</i>	<i>Frequency</i>
NDB	1 kw*	120/240, ± 10%, 1 phase, 4 wire	50 or 60 Hz ± 5%
* Power for environmental control is not included.			

8-148. The NDB transmitter will need battery backup power with automatic load transfer capability if the primary power source fails. Storage batteries capable of operating the transmitter for a minimum of 12 continuous hours are essential.

AIRFIELD ADVISORY OR OPERATIONS FACILITY

General Provisions

8-149. Airfield or heliport advisory service consists of giving information to arriving and departing aircraft concerning wind direction and speed, preferred runway, altimeter setting, pertinent known traffic and field conditions, airfield taxi routes and traffic patterns, and authorized instrument approach procedures. Airfield or heliport advisory service is at an AAF or AHP not served by a control tower or during hours the control tower is not operational. When the tower is not operational, control of the communications radios is transferred to remote control console located in the airfield or heliport operations room. Advisory facilities at locations not served by a control tower will have a small multi-channel communication control unit (CCU).

Special Provisions

8-150. If the control tower is the NAVAID monitoring facility, the advisory facility shall become the alternate NAVAID monitoring facility during hours the control tower is not in operation.

Equipment Guidance

8-151. Table 8-15 is a list of standard equipment used in advisory facilities.

Table 8-15. Major Equipment	
<i>Function</i>	<i>Type</i>
Remote control communication console	AN/FSC-92, STVS, ETVS
Communication control unit (CCU)	GRM Model TTC-8/800
Wind speed and direction indicator	FMQ-13
*VHF/FM receiver-transmitter radio	SINCGARS
*UHF transmitter	GRT/or CM200
*VHF transmitter	GRT/or CM200
*VHF receiver	GRR/or CM200
*UHF receiver	GRR/or CM200
* Normally, a part of the control tower equipment.	

Structural Standards

8-152. Standard structures do not exist for ATC advisory facilities. Adequate space for the electronic equipment with consideration toward maximizing human engineering is necessary.

8-153. Degree of environmental control necessary for a particular site is decided at the time of the site survey and is based on local conditions and technical characteristics of equipment involved.

Electrical Power Standards

8-154. Minimum requirements for full-load operation are as follows:

Table 8-16. Electrical Power Standards			
<i>Facility</i>	<i>Power</i>	<i>Voltage</i>	<i>Frequency</i>
Airfield advisory or operations facility	1 kw*	120/240, +/- 10%, 1 phase, 4 wire	50 or 60 Hz +/- 5%
* Power for environmental control is not included. This power requirement provides for consoles only. Power requirements for remote communications sites are contained in Section IV of this chapter.			

8-155. Backup power is normally not required for an advisory service.

WIND-MEASURING EQUIPMENT

General Provisions

8-156. Wind measuring set, AN/FMQ-13 or equivalent, determines runway wind velocity in the area where aircraft will be landing or taking off. The wind sensor is located in an area that allows unobstructed wind flow from all directions. The site must not be exposed to wind eddies caused by aircraft (rotorwash, propwash, or jet blast) and must be accessible for inspection and servicing of the transmitter. Readouts are in the ARAC facility, control tower cab, GCA room, advisory or operations, and weather facilities. All readouts must be paralleled to the individual runway sensor they are serving. Some airfields and/or heliports may require more than one windspeed, direction sensor, and readout indicator because of the simultaneous use of runways or helipads or peculiar terrain and distance characteristics.

Equipment Guidance

8-157. Table 8-17 lists the major standard equipment used at wind measuring facilities.

Table 8-17. Major Equipment	
<i>Function</i>	<i>Type</i>
Wind measuring set	AN/FMQ-13
Note: This item is normally supported and maintained by the U.S. Air Force.	

Structural Standards

8-158. The wind transmitter is self-contained and needs no external structure.

Electrical Power Standards

8-159. Minimum requirements for full-load operation are as follows:

Table 8-18. Electrical Power Standards			
<i>Facility</i>	<i>Power</i>	<i>Voltage</i>	<i>Frequency</i>
Wind Measuring Set	1 kw	115/230, ± 10%, 1 phase, 4 wire	47-63 Hz

8-160. This set will be in the backup power circuitry when such power is otherwise supplied at the airfield.

INSTALLATION AIC FACILITIES

General Provisions

8-161. In flight following, the en route progress and/or flight terminations of an aircraft are determined by aircraft position reporting procedures. This includes relaying to aircraft data on known factors affecting a flight such as weather conditions and planned artillery fires and air strikes.

Special Provisions

8-162. A remote communications facility (paragraph 8-116) is provided to minimize radio interference.

Equipment Guidance

8-163. Table 8-19 lists the major standard equipment used in flight-following facilities.

Table 8-19. Major Equipment – Installation AIC	
<i>Function</i>	<i>Type</i>
VHF/FM receiver-transmitter	SINCGARS
UHF/VHF/AM transceiver B/U	AN/GRC-171/211
VHF transmitter set	GRT/or CM200
UHF transmitter set	GRT/or CM200
VHF receiver	GRR/or CM200
UHF receiver	GRR/or CM200
Recorder/reproducer	DVRS (48 channels)
Communications console	AN/FSC-92 or ETVS
Speech security	SINCGARS with integrated communications security (ICOM)
Note: 50-watt amplifiers for transmitters will require special justification.	

Structural Standards

8-164. OCE has not established standard drawing requirements for flight-following facilities. As a minimum, the following floor space requirements should be included when considering design of a facility:

Table 8-20. Space and Amenity Requirements		
<i>Function</i>	<i>Operations Room</i>	<i>Maintenance/Equipment Room</i>
AIC	13' by 15'	13' by 15'
Notes:		
1. Each facility shall have a latrine and comfort station. 2. A remote communication site is essential.		

8-165. The communications equipment room environmental conditions shall be 75 ± 3 degrees Fahrenheit dry bulb for summer and winter with relative humidity less than 50 percent. Thermostats shall be set to the dry-bulb temperature that is currently recommended, based on considerations involving energy conservation and economics. Thermostat setting for summer cooling shall be 78 to 80 degrees Fahrenheit; winter heating, 65 to 68 degrees Fahrenheit.

8-166. Positive space pressure is necessary to reduce air infiltration.

8-167. As a backup to the environmental control system, a thermostatically controlled, roof-mounted exhaust unit must be supplied. A motorized damper shall be slaved to the exhaust unit control to control air flow through a filtered, sidewall exhaust-air inlet.

8-168. Operational areas shall be designed to make sure sound levels will not exceed MIL STD-1472B.

Electrical Power Standards

8-169. Minimum requirements for full-load operation are as follows:

Table 8-21. Electrical Power Standards			
<i>Facility</i>	<i>Power</i>	<i>Voltage</i>	<i>Frequency</i>
AIC	10 kw	120/240, ± 10%, 1 phase, 4 wire	50 or 60 Hz ± 5%
Note: Power for environmental control is not included in above requirements.			

8-170. The flight-following facility, including the operations and communications equipment, lights, and environmental control system, must have backup power with automatic start and load transfer capability in the event of a primary power failure.

AIRPORT/AIRFIELD LIGHTING SYSTEMS

General Provisions

8-171. Lighting systems include all the lights, signs, symbols, markings, and other devices located on and in the vicinity of an airfield to give pilots visual

reference to guide aircraft on the ground or in the air. Standard types of runway lighting systems used by the Army include the following.

- At nonprecision approach installations, a medium intensity runway lighting system (MIRLS) without approach lights is essential. If more flight guidance is necessary because of operational criteria (such as poor weather conditions) medium intensity approach lighting systems (MALS) may be authorized. Omnidirectional approach light systems (ODALS) is authorized and recommended at AAFs and AHPs servicing predominantly category A or B fixed-wing and/or rotary-wing aircraft, if other approach light systems offer no significant or essential operational advantages.

Note: No approach lights are required.

- Where precision approach light systems are authorized, a high intensity runway lighting system (HIRLS) is used with 1,500-foot short approach lighting system (SALS).
- When longer approach light systems are required to permit significant and required operational advantage, the high intensity approach lighting system (ALSF-1) or simplified short approach lighting system (SSALS) with runway alignment indicator lights (RAIL) is used. The latter combination is designated SSALR. Both systems include condenser discharged flashing lights (flasher or RAIL). Flashers or RAIL are physically identical, flashing a brilliant blue-white light in sequence toward the runway. When installed on centerline along the approach light system, the condenser discharged flashing lights are sequence flashers.

8-172. Control systems for runway and approach lighting facilities are an integral part of the control system for all airfield and heliport lighting facilities. This remotely energizes and de-energizes the selected runway and approach lighting systems and remotely controls the brightness of these systems, as needed by the operation of the airfield or heliport. The runway and approach lighting system controls (including rotating beacon, windsock, and wind tee) shall be located in, and controlled from, the control tower cab. Separate intensity controls for runway and approach lighting systems are necessary. Several lighting control options are available depending on the operational requirements.

8-173. **Manual remote control.** The airfield lighting system is manually remote controlled from the control tower cab; the control tower can control transfer to operations when the control tower is not manned.

8-174. **Pilot control of airport lighting.** Three types of radio controls on selected light systems can be used to control airfield and heliport lighting systems. Each type control can be activated for 15 minutes by a pilot keying the microphone in the aircraft five times in five seconds. A three-step system activates the lighting system at medium intensity and can be adjusted to high or low intensities. A two-step system must be activated first; then adjusted to only medium intensity. A third system will turn on a light system but the light intensity cannot be adjusted. In this system, the required level of intensity is set by the air traffic controller at the close of

each business day. Each sequence of microphone keying by a pilot provides 15 minutes of lights from the time of activation.

Table 8-22. Pilot Controlled Airport Lighting		
Type	Activation	Duration of Lighting
Three-step system	Pilot keys microphone 5 times within 5 seconds Activates lighting at medium intensity Can be adjusted to high or low intensities	15 minutes
Two-step system	Pilot keys microphone 5 times within 5 seconds Can only adjust to medium intensity	15 minutes
One-step system	Pilot keys microphone 5 times within 5 seconds, activating runway lighting. Intensity is not adjustable by pilot; it will be the intensity selected by the controller at the end of the duty day	15 minutes
Photoelectric system	Activated (on/off) by a photoelectric cell; Intensity is determined by controller at the end of each duty day	During the hours of darkness
Note: The lighting system can also be controlled <i>locally</i> at the lighting vault, which is usually located near the runway.		

8-175. **Photo electrically controlled.** Light systems are set at a certain level of brightness by the air traffic controller at the close of business each day. The system is activated (on/off) by a photoelectric cell.

Note: The lighting system can also be controlled *locally* at the lighting vault, which is usually located near the runway.

Equipment Guidance

8-176. Table 8-23 lists standard visual aids that may be used at AAFs and AHPs.

Table 8-23. Major Equipment	
Function	Type
Rotating beacon (light 24")	DCB-224/48034
Lighted wind cone (18" D X 8' L)	*FAA-AC 150/5345
Lighted wind tee	WT 43339C
Visual approach slope indicator (VASI)/precision approach path indicator (PAPI)	*FAA-AC 150/5340-14 *FAA-AC 150/5345-28
Gun, signal light	PTS 44859B
Overhead line markers	*FAA-AC 70/7460-10
*Federal Aviation Administration Advisory Circular	

Structural Standards

8-177. See TM 5-811-5 for information on supporting structures for visual aids.

Electrical Power Standards

8-178. See TM 5-811-5 for power requirements.

Engineering Installation Standards

8-179. The installation of visual aids and associated electrical power supplies, control wiring, and construction of mountings will conform to the applicable criteria in TM 5-811-5. See AFM 88-14 and FAA Handbook 6850.2 for information on visual aids.

ATC MISSION ESSENTIAL PECULIAR ITEMS

General Provisions

8-180. This section describes items difficult to identify but essential for U.S. Army ATC facilities.

Acoustical Floor Covering (Carpeting)

8-181. Antistatic carpeting is required in operational areas of control tower, ARAC, GCA, and AIC facilities.

8-182. Suggested carpet type is *Protector*, manufactured by Lees, series L8181 or an approved equivalent, and shall conform to the following specifications.

Table 8-24. Carpet Specifications	
Area	Value
Weave	Tufted
Gauge	1/1
Stitches per inch	6.0
Pile Height	.248
Face yarn	Antron III nylon
Face weight	23 ounces per yard
Backing material	Primary—Stabilene woven polypropylene Secondary—Thioboc woven polypropylene
Total weight	58.5 ounces per square yard
Width	12 feet
Flame spread	.75
Underwriters Laboratory 992 chamber test	Index 1.17
Noise reduction coefficient (on 40-ounce hairpad)	.55

Table 8-24. Carpet Specifications	
Area	Value
Static protection	3 kilovolt (kv) at 70° Fahrenheit and 20% relative humidity
Under layment for floor	40-ounce all hair, burlap mesh, center reinforcement

Bookcase, Desk, File Cabinet, and Chalkboard

Table 8-25. Furniture Specifications	
Furniture	Location
Bookcase	ATC facilities
Desk	ATC facilities
File Cabinet	ATC facilities
Chalkboard	ATC facilities
*High Back Chairs (2)	ATC Tower
*Note: Approved by DA for inclusion in CTA 50-909	

Flight Progress Strips/Strip Holders

8-183. Required at all ATC facilities.

Table 8-26. Progress Strips/Strip Holders		
ARAC	FAA Form 7230-7.2 NSN 7530-01-449-4250,	Perforated strips, no holder necessary.
Tower	FAA Form 7230-8 NSN 7530-01-449-4239 Strip holder, type 4 NSN 6605-00-485-2879.	
Flight following	FAA Form 7230-21 NSN 7530-01-449-4244 Strip holder, type 5 NSN 6605-00-485-6649.	

Headset/Microphone

8-184. One per controller is essential in all ATC towers, GCAs, AICs, and ARACs for the control of air traffic. Authorization for this item is in AR 310-49.

Reciprocating Counter

8-185. Required in all control towers. Hand type tally registers. Four-wheeled, registers to 9,999. Comes with reset knob, NSN 6680-00-641-3206.

Portable Signal-Light Gun Support Equipment

8-186. Retractable reels for portable signal-light gun. Two retractable reels for guns are required per control tower (one for power cable and one for support cable). Appleton SQ-1954B, reel, retractable, provides both with mounting plate. Lead time is 90 to 120 day freight on board from the factory. Manufacturer, Appleton Electric Company, 1701 Wellington Avenue, Chicago, Illinois 60657. Sales are through Graybar Electric Company, local distributor.

Vacuum Cleaner

8-187. Authorized by CTA 50-909 for those ATC facilities authorized carpeting.

Window Shades

8-188. Required at all ATC towers. Window shades are for use in bright sunlight and snow conditions. Shades must meet Federal Specification FAA-E-2470. Suggested type is manufactured by Plastic-View ATC, 4584 Runway, Suite B, Simi Valley, California 93063. The number of shades will be determined locally and shall be on all sides to reduce rear and side reflections.

PHYSICAL SECURITY REQUIREMENTS**General Provisions**

8-189. AR 190-13 requires that a physical security plan be written by the installation commander. As an annex to this security plan, a physical security plan for aviation facilities located on, or close to, an Army installation is essential (AR 190-51).

8-190. Security of aviation facilities includes ATC towers, ARACs, flight-following facilities, advisory/operations, remote communications facilities, wind measuring equipment, ILS (excluding marker beacons), and GCA facilities.

Standards for ATC and NAVAID Facilities

8-191. In addition to the provisions of AR 190-51 governing physical security of Army property at unit and installation level, the following requirements apply to ATC and NAVAID facilities:

- Control towers and ARAC facilities shall have a remotely controlled release lock for the main entrance door with intercom between entrance and supervisor position.
- TVOR facilities located off the confines of the AAF or AHP shall be provided a security fence constructed of wood or other non-metallic material. The fence will be a minimum of 150 square feet, 6 feet high, and include vehicle entrance gate and padlock.
- NDB and ILS marker beacon facilities located off the confines of the AAF or AHP shall require a chain link fence under AR 190-51, appendix E. The fence shall surround the plot to include vertical antenna or lean-ins to flat top antennas.

8-192. Windows and doors of all ATC and NAVAID facilities shall be secured as defined in AR 190-51, appendix C.

ENVIRONMENTAL CONTROL STANDARDS FOR ATC AND NAVAID FACILITIES

ENVIRONMENTAL GUIDANCE

8-193. This section provides environmental guidance for planning and designing ATC and NAVAID environmental control systems. Environmental control (conditioned air) is defined as the process of treating air to control, simultaneously, its temperature, humidity, cleanliness, and distribution to meet the requirements of the communications equipment space.

CRITICAL/NONCRITICAL APPLICABILITY

8-194. Critical standards are applicable to—

- Communications equipment spaces having equipment or supplies that need close control of space environment to reduce operational and maintenance problems and comply with equipment manufacturer recommendations.
- ARAC facilities.
- Areas that include a combination of critical and noncritical space/equipment.

8-195. Noncritical standards apply to—

- All other ATC facilities.
- NAVAID equipment spaces.

Critical/Noncritical Standards

8-196. Standards for critical and noncritical space/equipment is shown in the following table:

Table 8-27. Critical/Noncritical Environmental Control Standards		
Standard	Critical	Noncritical
1. Air conditioning, heating, ventilation, humidification, dehumidification, vapor barrier, and space ventilation.	Required	
2. Heating, ventilation, and space pressurization.		Required
3. Air conditioning, if within permissive weather zone, as indicated in AR 420-54, chapter 5, or DOD 4270.1-M, chapter 8.		Required
4. Humidification during heating system season, if within a low humidity area.		Permitted
5. Temperature and humidity design requirements.		
a. Outdoor. (TM 5-785)		
(1) Summer:		
(a) 1 % DC, 1% FWB.	Required	
(b) 2 ½ % FDB, 5% FWB.		Required
(2) Winter: 97 ½ %	Required	Required
b. Interior.		
(1) Summer:		
(a) 73 FDB ± 2 FDB. 45% ± 5% RH.	Required	
(b) 78 – 80 FDB, 50% ± 5% RH.		
(2) Winter:		

Table 8-27. Critical/Noncritical Environmental Control Standards

Standard	Critical	Noncritical
(a) 73 FDB \pm 2 FDB. 45% \pm 5% RH.	Required	
(b) 65 – 68 FDB when occupied.		Required
(c) 55 FDB when not occupied.		Required
6. Portable, clock wound, 24-hour chart, temperature/relative humidity recorder.	Required	
7. Ventilation and space pressurization.		
a. Equipment-space positive-pressure relative to exterior and adjacent nonequipment spaces.	Required	Required
b. Ten CFM minimum ventilation air per equipment-space occupant.	Required	Required
8. Air filters.		
a. Replaceable type with filter fram air seals and filter gauge.	Required	Required
b. Filter efficiency. (ASHRAE STD 52-68)		
(1) Direct outdoor air.		
(a) 5 – 15% pre-filter.	Required	Permitted
(b) Good quality air; 30 – 60% filter.	Required	Required
(c) Poor quality air due to excess dust, etc.; 85 – 95% filter.	Required	
(d) Ultra-high or carbon filter.	Required	
(2) Indirect outdoor air (as indicated in paragraph 7c) 30 – 60 % filter.	Required	Required
9. Effective vapor barrier on equipment-space walls, floor, subfloor, ceiling or roof.	Required	
10. Equipment-space sidewall, ceiling, floor, subfloor coating to reduce surface erosion, which contributes to space-dust level.	Required	
11. Weather stripping at doors opening to exterior and adjacent nonequipment spaces.	Required	Required
12. Automatic door closures on primary traffic doors opening to exterior and nonequipment spaces.	Required	Required
13. Air locks at primary exterior entrance doors wherever poor quality outdoor air, extreme low/high outdoor temperature, and high humidity are prevalent.	Required	Required
14. Air seals.		
a. At equipment-space conduit pipe, air duct, cable, tray, etc., side wall penetrations.	Required	Required
b. Around raised floor penetrations, raised floor perimeter, and interface of raised floor and supporting stringers and pedestal heads.	Required	
c. At interface of raised floor and air condition support stand.	Required	
d. Required on all modulating air campers to reduce damper air leakage when closed.	Required	Required

Table 8-27. Critical/Noncritical Environmental Control Standards

<i>Standard</i>	<i>Critical</i>	<i>Noncritical</i>
15. Raised floor conditioned air supply plenum.		
a. Relative humidity less than 80%.	Required	
b. Plenum air pressure greater than 0.3 inches water gauge to serve communications equipment having floor cutout air inlets at floor and equipment interface.	Required	
c. Subfloor drain with cleanout.	Required	
d. 16 – 18 inch minimum elevation between concrete subfloor and bottom of raised floor support stringers.	Required	
e. Insulate air plenum water, drain, and refrigerant lines.	Required	
16. Raised floor, mounted air registers or perforated panel air outlets.	Required	
a. Readily relocatable.	Required	
b. Volume control damper.	Required	
c. Load-bearing strength equal to that of floor panel.	Required	
d. Compute quantity (N) of air outlets $N = \frac{TR-TE-TC}{Q} + 10\%$ Where TR = Space-total computed air quantity, CFM. TE = Air quantity required by communication equipment having direct cooling air, supplied through raised floor cutouts within equipment base area. TC = Estimated raised-floor air leakage by way of cable cutouts, etc., CFM. Q = Recommended air outlet air-flow rate, CFM.	Required	
17. Equipment-space air-distribution system requires built-in flexibility, which will permit ready air redistribution to satisfy needs of new or relocated equipment.	Required	Required
18. Conditioned air distribution shall assure equipment space:		
a. " Hot spots" do not occur.	Required	Required
b. Space temperature, at elevation, is uniform throughout equipment space.	Required	Required
c. Air supply does not short-circuit back to return inlets.	Required	Required
d. Return-air path to return-air inlets is minimal.	Required	Required
e. Equipment enclosure, temperature rise does not exceed 16 ° F, or reach equipment temperature cutoff setpoint.	Required	Required
19. Rate of heat gain per equipment-space occupant.		
a. 250 BTU/hour sensible.	Required	Required
b. 200 BTU/hour latent.	Required	Required
20. Rest room, if within equipment-environmental zone, exhaust rate should not exceed 20 CFM per rest room occupant.	Required	Required
21. Vibration noise isolators required between air conditioners/pumps and supports, and at interconnection with piping, conduit, and ductwork.	Required	Required

Table 8-27. Critical/Noncritical Environmental Control Standards		
Standard	Critical	Noncritical
22. Outside ventilation air damper shall close when equipment-space is not occupied.	Required	Required
23. Utilized, computer-room-type air conditioning units with redundancy.	Required	
24. Life-cycle-cost-economic analysis shall be used to determine the most effective air conditioning system.	Required	Required
25. Occupied communications equipment-installed-space air conditioners, air-supply outlets, return-air-grille, ductwork sound-level shall not exceed noise criteria NC-45, MIL STD 1472.	Required	Required
26. Inclined, water-gauge manometer is required to indicate raised-floor plenum/equipment-space differential pressure.	Required	
27. Outdoor air cooling (economizer cycle).		
a. Comply with paragraph 8-5.16A and 8-5.16B of DOD 4270.1-M. Note: Exceptions to requirements as indicated within paragraph 5.6 of ASHRAE Standard 90-75.		Required
b. Economizer activation. -Enthalpy controller whenever humidity is excessive. -Outdoor-air, dry-bulb controller otherwise.		Required
28. Consideration must be given to the use of energy recovery systems to reduce energy requirements.	Required	Required
29. Battery ventilation. Provisions shall be made for sufficient diversion and ventilation of gases from battery to prevent accumulation of an explosive mixture. (National electrical code) Accumulation of hydrogen gas shall not exceed a level of 3% by volume in the room air at anytime. For a maximum of 3% concentration of hydrogen, the minimum amount of exhaust ventilation needed is given by the equation $Q = 0.009IN(2)$. Where -- Q = air (CFM). I = charging current. N = Number of battery cells. (2) = Factor to compensate for inefficiencies in ventilation system. If battery room is air conditioned as part of a general building-wide air conditioning system, the exhaust air from the battery room should not be returned to the air distribution system. The room should have its own exhaust system direct to the outdoors.		
Notes: ASHRAE - American Society of Heating, Refrigeration, and Air Conditioning Engineers. BTU - British Thermal Unit CFM - cubic feet per minute F - Fahrenheit FDB - Fahrenheit dry bulb FWB - Fahrenheit wet bulb RH - relative humidity		

Appendix A

Training and Proficiency Records

This appendix explains how to complete and maintain training record folders, DA Form 3479-R, DA Form 3479-9-R, and DA Form 3479-10-R. This appendix should be used as a guide; it does not cover every possible situation.

SECTION I – TRAINING RECORD LABELS

A-1. Training and proficiency record folders shall be labeled in accordance with AR 25-400-2 and this manual. Figure A-1 (dummy folder) and figure A-2 (training folder) show the standard labels, facilities, and maintenance supervisors shall use.

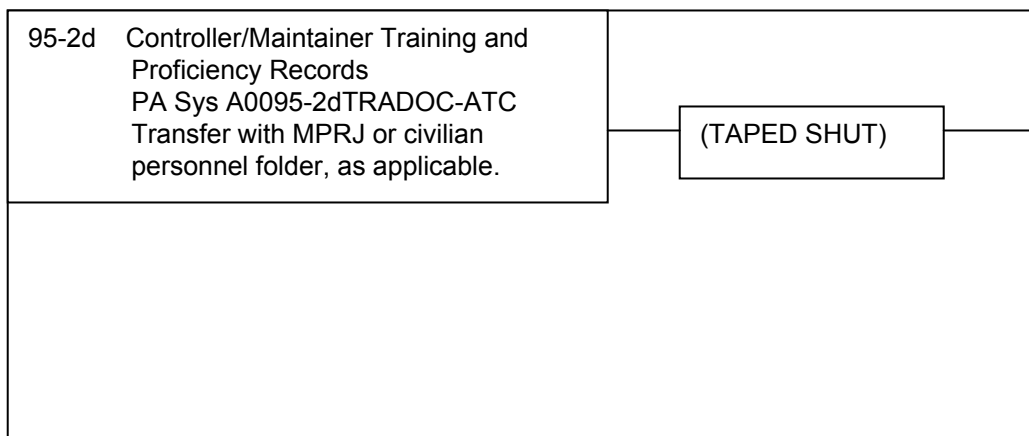

Figure A-1. Standardized ATC Record Dummy Folder

95-2d	Doe, John C. Jr. 249-39-6969
<p>AIR TRAFFIC CONTROL /MAINTENANCE INDIVIDUAL TRAINING RECORD FOLDER, UNITED STATES ARMY</p> <p>IF FOUND, MAIL TO: Commander, USAAVNC ATTN: ATZQ-ATC</p>	

Figure A-2. Standardized ATC Record Folder

SECTION II – CONTROLLER TRAINING AND PROFICIENCY RECORD (DA FORM 3479-R)

A-2. Instructions for completing and maintaining DA Form 3479-R and DA Form 3479-1-R (*Trainee/Controller Evaluation*) can be found in chapters 6 and 7. Figure A-3 provides an example of a completed DA Form 3479-R. The following documents shall be placed on the right side of the folder from bottom to top:

- DA Form 4186, *Medical Recommendation for Flying Duty*.
- DA Form 4186 for Grounding. (on top, remove upon receipt of up slip).
- Tests (separate tactical from installation with divider).
 - Post trainees name, date, test subject, graders initials, and SAT/UNSAT grade in bottom right hand corner.
- DA Form 3479-1-R (separate tactical from installation with divider).
 - Number the DA Form 3479-1-R with the last two digits of the year and the number of evaluations given that year. (for example, ninth 1-R given in 2001 will be numbered 01-09.)
 - Tactical DA Form 3479-1-Rs shall be a “T” in front of the year. (for example, T01-09).
 - It is authorized to have both a tactical and installation DA Form 3479-1-R numbered 02-01, with the “T” being the only difference. (for example, T02-01.)
 - In section V of the tactical DA Form 3479-1-R, under the position column, the type of facility shall be included with the position. (for example, 71B FD, 7A FD.)

TRAINING AND PROFICIENCY RECORD - AIR TRAFFIC CONTROLLER For use of this form, see FM 3-04.303; the proponent agency is TRADOC							
GENERAL INFORMATION This form consists of Sections I through VII. It will be used as an authoritative source of information and reference in regard to the individual's training record as an air traffic controller in the United States Army and as a comprehensive training progress report. The ATC Chief/ATC SR SGT/PSG/facility chief or the training NCO/supervisor shall record the required entries within this form.							
SECTION I - PERSONAL IDENTIFYING DATA							
NAME (Last, first, middle initial)	ASGD INIT (Pencil)	RANK (Pencil)	CTO NUMBER	ATCS NO.	PMOS	DMOS (Pencil)	
DOE, JOHN C. JR.	<i>[Signature]</i>	SSGt	249396969	9900	93C	93C30	
EXPIRATION DATE OF FLIGHT PHYSICAL (Pencil)				EXPIRATION TERM OF SERVICE (Pencil)			
31 May 02				30 Feb 06			
NAME AND LOCATION OF FACILITY TO WHICH ASSIGNED	DUTIES PERFORMED	DATE ASSIGNED		TYPE CERTIFICATES, AWARDS; DATES AND REMARKS			
		FROM	TO				
HUNTER TOWER HUNTER AAF, GA	TRAINEE	15 MAR 94	15 DEC 94	SEE SECTION VI # 2 CTO/ATCS 15 DEC 94			
	CONTROLLER	15 DEC 94	12 AUG 95				
	SHIFT SUPERVISOR	12 AUG 95	20 DEC 95	SEE SECTION VI-1 # 3			
DESIDERIO GCA CAMP HUMPHREYS, ROK	TRAINEE	1 FEB 96	27 JUL 96	SEE SECTION VI-1 # 5 ATCS 27 JUL 96			
	CONTROLLER	27 JUL 96	24 JAN 97	SEE SECTION VI-2 # 1			
AN/TSQ-71B CAMP HUMPHREYS, ROK	TRAINEE	30 JUL 96	20 SEP 96	SEE TAC SECTION VI # 1 RATED AN/TSQ-71B ATCS 20 SEP 96			
	CONTROLLER	20 SEP 96	1 DEC 96	SEE TAC SECTION VI # 2			
AN/TSQ-97A HUNTER AAF, GA	TRAINEE	12 MAR 97	20 MAY 97	RATED AN/TSQ-97A ATCS 20 MAY 97			
	CONTROLLER	20 MAY 97	17 SEP 97				
	FACILITY CHIEF	17 SEP 97	1 FEB 00	SEE TAC SECTION VI # 1 & 2			
AN/TSW-7A CAMP MCGOVERN, BOSNIA	TRAINEE	13 JAN 98	30 JAN 98	SEE TAC SECTION VI # 5 & 6 RATED AN/TSW-7A ATCS 30 JAN 98			
	CONTROLLER	30 JAN 98	17 JAN 99	SEE TAC SECTION VI # 7			

DA FORM 3479-R, JUN 2003

DA Form 3479-R, Mar 1989, is obsolete

1

USAPA V1.00

Figure A-3. DA Form 3479-R Example

SECTION I - PERSONAL IDENTIFYING DATA <i>(Continued)</i>				
NAME AND LOCATION OF FACILITY TO WHICH ASSIGNED	DUTIES PERFORMED	DATE ASSIGNED		TYPE CERTIFICATES, AWARDS; DATES AND REMARKS
		FROM	TO	
AN/TSW-7A CAMP MCGOVERN, BOSNIA	SHIFT SUPERVISOR	1 MAR 98	17 JAN 99	SEE TAC SECTION VI # 7
AN/TSW-7A HUNTER AAF, GA	CONTROLLER	22 JAN 99	1 FEB 00	SEE TAC SECTION VI-1 # 1&2
FOC-K (GUARDIAN CONTROL) Yongsan, ROK	TRAINEE	1 JUL 00	28 JUL 00	SEE SECTION VI-2 #2,3, & 4

DA FORM 3479-R, JUN 2003

1- 1
USAPA V1.00

Figure A-3. DA Form 3479-R Example (Continued)

SECTION II - SCHOOLS ATTENDED		
NAME OF SCHOOL	LOCATION	DATE COMPLETED
U.S. ARMY ATC SCHOOL	FORT RUCKER, AL	20 FEB 94
BNCOC	FORT RUCKER, AL	29 MAY 00

DA FORM 3479-R, JUN 2003 2- _____
USAPA V1.00

Figure A-3. DA Form 3479-R Example (Continued)

SECTION III - QUALIFICATION, PROFICIENCY, AND REMEDIAL TRAINING RECORD				
SUBJECT	TYPE	DATE	HOURS	REMARKS
Facility Indoctrination	Q	17 Mar 94	8	
FTM Chapter 1	Q	17 Mar 94	8	
Primary Knowledge	Q	21 Mar 94	24	
FTM Chapter 2	Q	18 Mar 94	8	
Initial Weather Certification	Q	21 Mar 94	3	USAF
DVRS Procedures	Q	18 Mar 94	5	
FTM Chapters 3 & 4	Q	19 Mar 94	8	
Position Qualification	Q	9 Dec 94	559	
Flight Data	Q	20 May 94	64	
Ground Control	Q	11 Aug 94	145	
Local Control	Q	9 Dec 94	350	
Facility Rating	Q	15 Dec 94	10	
Facility Equipment PMCS/DA Form 2404	Q	22 Mar 94	3	
FTM Chapter 8	Q	1 Apr 94	6	
FTM Chapter 5	Q	7 Apr 94	4	
FTM Chapter 6	Q	15 Apr 94	3	
FTM Chapter 7	Q	18 Apr 94	2+30	

DA FORM 3479-R, JUN 2003

3- _____

USAPA V1.00

Figure A-3. DA Form 3479-R Example (Continued)

SECTION III - QUALIFICATION, PROFICIENCY, AND REMEDIAL TRAINING RECORD				
SUBJECT	TYPE	DATE	HOURS	REMARKS
LOAs, OPS LTRS, Class C/D Airspace Diagram	Q	22 Apr 94	4	
Facility Memorandums / AIG Messages	Q	24 Apr 94	3	
Chapters 1& 2 FAAH 7110.65	Q	28 Apr 94	3	
Chapters 1 thru 3 FM 1-303	Q	6 May 94	4	
FS 95-1, AR 95-2, AR 40-8, AR 40-501, AR 385-95	Q	10 May 94	8	
FLIPs and AIM	Q	14 May 94	3+30	
FTM Chapter 12	Q	18 May 94	2	
Chapter 3 FAAH 7110.65 Sections 3.1 thru 3.7	Q	28 May 94	8	
Chapters 4 & 7 FM 1-303	Q	5 Jun 94	6	
Chapter 10 FAAH 7110.65	Q	17 Jun 94	14	
Chapter 7 FAAH 7110.65 Sections 7.1 thru 7.5	Q	15 Jul 94	7	
FTM Chapter 9	Q	1 Aug 94	3	
Chapter 3 FAAH 7110.65 Section 9 Wake Turbulence	Q	15 Aug 94	15	
FTM Chapter 8 Flight Strip Markings	Q	24 Oct 94	10	1-R # 94-22 Retest See Section VI # 4
DBRITE Controls and Operations	Q	7 Nov 94	36	
Chapter 3 FAAH 7110.65 Sections 3.8 thru 3.12	Q	6 Dec 94	8	
PRE-ATCS Exam	Q	10 Dec 94	6	

DA FORM 3479-R, JUN 2003

3- 1
USAPA V1.00

Figure A-3. DA Form 3479-R Example (Continued)

SECTION III - QUALIFICATION, PROFICIENCY, AND REMEDIAL TRAINING RECORD				
SUBJECT	TYPE	DATE	HOURS	REMARKS
FTM Chapter 13 Facility Administration	Q	10 Jan 95	3	
Annual Weather Certification	P	5 Feb 95	3	USAF
Training Record Entries	Q	8 Mar 95	2	IAW AIG 95-02
Accident/Incident Reporting Procedures	Q	5 Jun 95	2	IAW AIG 95-05
Review Current AIG Messages thru 95-08	P	17 Jul 95	2+30	
Review AR 40-8, AR 40-501 and AR 95-2	P	13 Sep 95	3	
Flight Strip Markings	P	7 Nov 95	2+45	
RECORDS CLOSED		20 DEC 95		/S/ JOHN H. SMITH, SFC, USA, Training Supervisor
Facility Indoctrination	Q	1 Feb 96	2+30	
FTM Chapter 1	Q	2 Feb 96	2+30	
Primary Knowledge	Q	12 Feb 96	11	
FTM Chapters 2 thru 4	Q	5 Feb 96	8	
Radiation SOP	Q	9 Feb 96	1	
DVRS DAT Tape Changing, Marking, & Storing	Q	12 Feb 96	2	
Position Qualification	Q	20 Jul 96	172	
Flight Data	Q	15 Apr 96	67	
Facility Equipment PMCS & DA Form 2404	Q	15 Feb 96	3	

DA FORM 3479-R, JUN 2003

3- 2

USAPA V1.00

Figure A-3. DA Form 3479-R Example (Continued)

SECTION III - QUALIFICATION, PROFICIENCY, AND REMEDIAL TRAINING RECORD				
SUBJECT	TYPE	DATE	HOURS	REMARKS
AN/FSC-92(v) Re-Boot Procedures	Q	20 Feb 96	2	
Flips, Charts VFR & IFR Supplements	Q	26 Feb 96	2	
AR 40-8 and Current AIG Messages	Q	3 Mar 96	4	
AR 95-2 Chapters 2 thru 5	Q	8 Mar 96	3	
AWDS Training	Q	8 Mar 96	3	
AR 40-501 Chapter 6	Q	8 Mar 96	1	
FTM Chapter 5 Emergency Procedures	Q	20 Mar 96	2	
FAAH 7110.65 Chapter 10	Q	21 Mar 96	2	
FTM Chapter 6	Q	23 Mar 96	2	
FM 1-303 Chapter 1 thru 4	Q	24 Mar 96	2+30	
FM 1-303 Chapter 5 & 7	Q	27 Mar 96	3	
FAAH 7110.65 Chapter 2	Q	6 Apr 96	2	
AR 95-10 NOTAMs	Q	6 Apr 96	1	
FAAH 7110.65 Chapter 5 Section 4	Q	8 Apr 96	1+30	
DA Forms 2696-R, 3501-R 3502-R and 3503-R	Q	11 Apr 96	3	
FTM Chapters 7 & 8	Q	15 Apr 96	2+30	
ASR / PAR	Q	20 Jul 96	105	

DA FORM 3479-R, JUN 2003

3- 3

USAPA V1.00

Figure A-3. DA Form 3479-R Example (Continued)

SECTION III - QUALIFICATION, PROFICIENCY, AND REMEDIAL TRAINING RECORD				
SUBJECT	TYPE	DATE	HOURS	REMARKS
FTM Chapters 9 & 12	Q	15 Jun 96	2	
FTM Chapters 10 & 11	Q	30 Jun 96	4	
FAAH 7110.65 Chapter 5	Q	2 Jul 96	8	
PAR Lower Safety Limits	Q	15 Jul 96	6	
ASR / PAR Cursor Alignment	Q	20 Jul 96	20	
Facility Rating	Q	27 Jul 96	28	
Pre-ATCS Exam	Q	24 Jul 96	4	
FTM Chapter 13	Q	29 Jul 96	2	
Initial Weather Certification	Q	3 Dec 96	2	USAF
ASR / PAR Cursor Alignments	P	3 Dec 96	2	
//// RECORDS CLOSED-----	-----	----24 JAN 97----	-----	/S/ THOMAS J. LYONS, SPC, USA, Training Supervisor
Facility Indoctrination	Q	1 Jul 00	2	
Primary Knowledge	Q	2 Jul 00	4	
Position Qualification	Q			
South / Evenreach FD	Q			
South / Evenreach FF	Q			
North / Warrior FD	Q			

DA FORM 3479-R, JUN 2003

3- 4

USAPA V1.00

Figure A-3. DA Form 3479-R Example (Continued)

SECTION III - QUALIFICATION, PROFICIENCY, AND REMEDIAL TRAINING RECORD				
SUBJECT	TYPE	DATE	HOURS	REMARKS
North / Warrior FF	Q			
Facility Rating	Q			
DOD Flips	Q	2 Jul 00	2	
USFK Regulations 95-13, 95-14	Q	16 Jul 00	1	
EUSA Regulation 95-33	Q	16 Jul 00	1	
AR 95-2	Q	20 Jul 00	1	
AR 40-8	Q	20 Jul 00	1	
DVRS Procedures	Q	14 Jul 00	2	
LOAs	Q	2 Jul 00	1	
A2C2	Q	6 Jul 00	4	
Soldier 911		8 Jul 00	2	
AN/FSC-92(v) Re-Boot Procedures		8 Jul 00	2	
ATIS		8 Jul 00	1	
Initial Weather Certification		26 Jul 00	3	USAF
FAAO 7110.65 thru Chapter 4		26 Jul 00	2	
RECORDS CLOSED-----	-----	-----1 AUG 00----	-----	/S/ STAN TENTPEGS, SFC, USA, Facility Chief, Guardian Control See Section VI-2 # 1 & 2

DA FORM 3479-R, JUN 2003

3- 5

USAPA V1.00

Figure A-3. DA Form 3479-R Example (Continued)

SECTION IV - WRITTEN/ORAL/PRACTICAL TEST ACTION			
SUBJECT	DATE	SCORE	REMARKS
FTM Chapter 1	17 Mar 94	SAT	
FTM Chapter 2	18 Mar 94	SAT	
Initial Weather Certification	21 Mar 94	SAT	USAF
DVRS Procedures	18 Mar 94	SAT	Oral / Practical
FTM Chapters 3 & 4	19 Mar 94	SAT	
FTM Chapter 8	1 Apr 94	SAT	
FTM Chapter 5	7 Apr 94	SAT	
FTM Chapter 6	15 Apr 94	SAT	
FTM Chapter 7	18 Apr 94	SAT	
Chapters 1 & 2 FAAH 7110.65	28 Apr 94	SAT	
FM 1-303 Part I	6 May 94	SAT	
FS 95-1, AR 95-2, AR 40-8 AR 40-501, AR 385-95	10 May 94	SAT	
FLIPs and AIM	14 May 94	SAT	Open Book
FTM Chapter 12	18 May 94	SAT	
Flight Data Position Qualification Test	20 May 94	SAT	PQ FD
FAAH 7110.65 Chapter 3 Part I	28 May 94	SAT	
FM 1-303 Part II	5 Jun 94	SAT	

DA FORM 3479-R, JUN 2003

4- _____

USAPA V1.00

Figure A-3. DA Form 3479-R Example (Continued)

SECTION IV - WRITTEN/ORAL/PRACTICAL TEST ACTION			
SUBJECT	DATE	SCORE	REMARKS
FAAH 7110.65 Chapter 10	17 Jun 94	SAT	
FTM Chapter 9	1 Aug 94	SAT	
Ground Control Position Qualification Test	11 Aug 94	SAT	PQ GC
FAAH 7110.65 Chapter 3 Section 9 Wake Turbulence	15 Aug 94	SAT	
FTM Chapter 8 Flight Strip Markings	24 Oct 94	SAT	1-R # 94-22 Retest See Section VI # 4
DBRITE Controls And Operations	7 Nov 94	SAT	Oral / Practical
FAAH 7110.65 Chapter 3 Part II	6 Dec 94	SAT	
Local Control Position qualification Test	9 Dec 94	SAT	PQ LC
PRE-ATCS Exam	10 Dec 94	SAT	
CTO/FAA Exam	15 Dec 94	SAT	ATCS/CTO Rated
FTM Chapter 13	10 Jan 95	SAT	
Annual Weather Certification	5 Feb 95	SAT	USAF
Training Record Entries	8 Mar 95	SAT	IAW AIG 95-02 / Practical
Accident/Incident Reporting Procedures	5 Jun 95	SAT	IAW AIG 95-05
Flight Strip Markings	7 Nov 95	SAT	Practical
RECORDS CLOSED-----	20 DEC 95	/S/ JOHN H. SMITH,	SFC, USA, Training Supervisor
FTM Chapter 1	2 Feb 96	SAT	

DA FORM 3479-R, JUN 2003

4- 1

USAPA V1.00

Figure A-3. DA Form 3479-R Example (Continued)

SECTION IV - WRITTEN/ORAL/PRACTICAL TEST ACTION			
SUBJECT	DATE	SCORE	REMARKS
FTM Chapter 2 thru 4	5 Feb 96	SAT	
DVRS Procedures	12 Feb 96	SAT	Oral / Practical
AN/FSC-92(v) Re-Boot Procedures	20 Feb 96	SAT	Oral / Practical
Flips, Charts, VFR / IFR Supplements	26 Feb 96	SAT	Oral / Practical
AR 40-8	3 Mar 96	SAT	
AR 95-2	8 Mar 96	SAT	
FTM Chapter 5	20 Mar 96	SAT	
FAAH 7110.65 Chapter 10	27 Mar 96	SAT	
FTM Chapter 6	2 Apr 96	SAT	
FM 1-303 Chapters 1 thru 4	3 Apr 96	SAT	
FM 1-303 Chapters 5 & 7	9 Apr 96	SAT	
FAAH 7110.65 Chapter 2	18 Apr 96	SAT	
FAAH 7110.65 Chapter 5 Section 4	28 Apr 96	SAT	
FTM Chapters 7 & 8	10 Jun 96	SAT	
Flight Data PQ Exam	10 Jun 96	SAT	Written/Oral/Practical
FTM Chapters 9 & 12	15 Jun 96	SAT	
FTM Chapters 10 & 11	30 Jun 96	SAT	

DA FORM 3479-R, JUN 2003

4- 2

USAPA V1.00

Figure A-3. DA Form 3479-R Example (Continued)

SECTION IV - WRITTEN/ORAL/PRACTICAL TEST ACTION			
SUBJECT	DATE	SCORE	REMARKS
FAAH 7110.65 Chapter 5	2 Jul 96	SAT	
ASR/PAR Cursor Alignment	20 Jul 96	SAT	
ASR/PAR PQ Exam	20 Jul 96	SAT	Oral/Practical
Pre-ATCS Exam	24 Jul 96	SAT	Written/Oral/Practical
ATCS Exam	27 Jul 96	SAT	
FTM Chapter 13	29 Jul 96	SAT	
Initial Weather Certification	29 Jul 96	SAT	USAF
ASR/PAR Cursor Alignment	3 Dec 96	SAT	Oral/Practical
RECORDS CLOSED-----	24 JAN 97	/S/ THOMAS J.	LYONS, SPC, USA, Training Supervisor
Facility Indoctrination	1 Jul 00	SAT	FTM Chapter 1
Primary Knowledge	2 Jul 00	SAT	FTM Chapter 2 thru 4
DOD Flip, VFR ARR/DEP RTE	2 Jul 00	SAT	
DOD Flip FIH	2 Jul 00	SAT	
DOD Enroute Supplement	2 Jul 00	SAT	
LOAs	2 Jul 00	SAT	
A2C2	3 Jul 00	SAT	
Soldier 911	8 Jul 00	SAT	ORAL

DA FORM 3479-R, JUN 2003

4- 3
USAPA V1.00

Figure A-3. DA Form 3479-R Example (Continued)

SECTION IV - WRITTEN/ORAL/PRACTICAL TEST ACTION			
SUBJECT	DATE	SCORE	REMARKS
AN/FSC-92(v) Re-Boot Procedures			
ATIS			
DVRS Procedures			
EUSA Reg 95-33 USFK REGs 95-13 & 95-14			
AR 40-8 & 95-2			
Initial Weather Certification			
FAAO 7110.65 Chapter 1 thru 4			
RECORDS CLOSED-----	1 AUG 00,	/S/ STAN TENTPEGS,SFC, USA,	Facility Chief, Guardian Control See Section VI-2 # 1 & 2

DA FORM 3479-R, JUN 2003

4- 4

USAPA V1.00

Figure A-3. DA Form 3479-R Example (Continued)

SECTION V - PROFICIENCY CHECKS						
POSITION	DATE	SCORE	HOURS	INITIALS		REMARKS
				ATC	SUPV	
FD	29 MAR 94	U	6+00	JD	JS	94-01
FD	6 APR 94	S	6+00	JD	JS	94-02
FD	16 APR 94	U	4+00	JD	CW	94-03
FD	24 APR 94	S	6+00	JD	JS	94-04
FD	5 MAY 94	S	5+00	JD	CW	94-05
FD	12 MAY 94	S	6+00	JD	CW	94-06
FD	18 MAY 94	S	4+00	JD	JS	94-07 Recommend PQ
FD	20 MAY 94	S	4+00	JD	CW	94-08 FD PQ
GC	30 MAY 94	U	4+00	JD	CW	94-09
GC	9 JUN 94	U	5+00	JD	CW	94-10
FD	18 JUN 94	S	2+00	JD	CW	94-11 Proficiency
GC	21 JUN 94	U	4+00	JD	JS	94-12
GC	29 JUN 94	U	5+00	JD	CW	94-13
GC	7 JUL 94	S	6+00	JD	CW	94-14
GC	15 JUL 94	S	5+30	JD	JS	94-15
FD	17 JUL 94	S	2+00	JD	DT	94-16 Proficiency
GC	21 JUL 94	S	6+00	JD	JT	94-17

DA FORM 3479-R, JUN 2003

5- _____
USAPA V1.00

Figure A-3. DA Form 3479-R Example (Continued)

SECTION V - PROFICIENCY CHECKS						
POSITION	DATE	SCORE	HOURS	INITIALS		REMARKS
				ATC	SUPV	
GC	25 JUL 94	S	6+45	JD	CW	94-18
GC	6 AUG 94	S	5+00	JD	JS	94-19 Recommend PQ
GC	11 AUG 94	S	4+00	JD	CW	94-20 GC PQ
FD/GC	14 AUG 94	S	3+00	JD	CW	94-21 Proficiency
FD/GC	22 OCT 94	S	4+45	JD	CW	94-22 See Section VI # 4 Proficiency
FD	24 OCT 94	S	3+00	JD	JS	94-23 See Section VI # 5 Proficiency
LC	26 OCT 94	S	5+00	JD	DT	94-24
FD/GC	9 NOV 94	S	3+00	JD	CW	94-25 Proficiency
LC	9 NOV 94	S	4+15	JD	DT	94-26
LC	15 NOV 94	S	2+00	JD	JS	94-27
LC	25 NOV 94	S	4+00	JD	JS	94-28
FD/GC	26 NOV 94	S	4+30	JD	DT	94-29 Proficiency
LC	5 DEC 94	S	7+30	JD	DT	94-30
LC	8 DEC 94	S	7+30	JD	JS	94-31 Recommend PQ
LC	9 DEC 94	S	7+30	JD	CW	94-32 LC PQ
FD/GC/LC	13 DEC 94	S	7+30	JD	JS	94-33 Recommend Rating
FD/GC/LC	15 DEC 94	S	2+00	JD	CW	94-34 ATCS/CTO Rated

DA FORM 3479-R, JUN 2003

5- 1

USAPA V1.00

Figure A-3. DA Form 3479-R Example (Continued)

SECTION V - PROFICIENCY CHECKS						
POSITION	DATE	SCORE	HOURS	INITIALS		REMARKS
				ATC	SUPV	
FD/GC/LC	1 MAY 95	S	7+00	JD	JS	95-01 See Section VI # 8 Proficiency
FD/GC/LC	1 SEP 95	S	6+00	JD	CW	95-02 See Section VI-1 # 1 Proficiency
---RECORDS CLOSED---	---20 DEC 95, ---	/S/	JOHN	H.	-----	SMITH, SFC, USA TRNG Supervisor
FD	20 Feb 96	S	4+00	JD	DM	96-01
FD	2 Mar 96	S	5+00	JD	LS	96-02
FD	10 Mar 96	U	3+00	JD	DM	96-03
FD	19 Mar 96	S	4+15	JD	DM	96-04
FD	28 Mar 96	S	2+00	JD	DM	96-05
FD	6 Apr 96	S	2+00	JD	KM	96-06
FD	14 Apr 96	S	6+00	JD	LS	96-07 Recommend PQ
FD	15 Apr 96	S	3+30	JD	KM	96-08 FD PQ
ASR/PAR	20 Apr 96	S	5+00	JD	AW	96-09
ASR/PAR	28 Apr 96	S	7+00	JD	AW	96-10
FD	28 Apr 96	S	2+00	JD	LS	96-11 Proficiency
FD	1 Jun 96	S	4+45	JD	KM	96-12 See Section VI dated 1 Jun 96 Proficiency
ASR/PAR	2 Jun 96	U	5+30	JD	DM	96-13
ASR/PAR	11 Jun 96	U	6+00	JD	LS	96-14

DA FORM 3479-R, JUN 2003

5- 2

USAPA V1.00

Figure A-3. DA Form 3479-R Example (Continued)

SECTION V - PROFICIENCY CHECKS						
POSITION	DATE	SCORE	HOURS	INITIALS		REMARKS
				ATC	SUPV	
ASR/PAR	20 Jun 96	U	3+30	JD	LS	96-15
FD	28 Jun 96	S	3+00	JD	LS	96-16 Proficiency
ASR/PAR	7 Jul 96	S	2+00	JD	AW	96-17
ASR/PAR	15 Jul 96	S	7+30	JD	LS	96-18 Recommend PQ
ASR/PAR	20 Jul 96	S	4+00	JD	KM	96-19 ASR/PAR PQ
FD/ASR/PAR	26 Jul 96	S	8+00	JD	LS	96-20 Recommend Rating
FD/ASR/PAR	27 Jul 96	S	6+00	JD	KM	96-21 ATCS Rating
---RECORDS CLOSED---	-----24 JAN 97,---	/S/	-----	-----	-----	THOMAS J. LYONS, SPC, USA, Training Supervisor
South/ Evenreach FD	12 Jul 00	S	3+00	JD	CJ	00-01
South/ Evenreach FD	20 Jul 00	S	4+30	JD	CJ	00-02 See Section VI-2 # 1 & 2
--RECORDS CLOSED, --	-----1 AUG 00, ---	/S/	-----	-----	-----	STAN TENTPEGS, SFC, USA, Facility Chief, Guardian Control

DA FORM 3479-R, JUN 2003

5- 3

USAPA V1.00

Figure A-3. DA Form 3479-R Example (Continued)

SECTION VI - MISCELLANEOUS GENERAL COMMENTS	
1 14 Mar 94 - PFC Doe assigned this date. Received in-briefing, facilities tour and FTM. Reviewed Chap1. FM 1-303, and AR 95-2 (Training Time Limitations). Verified ATCS card, Up-slip, Security Clearance. and Certificate of grades. Assigned operating initials are "JD". Training time will start 15 Mar 94.	
NAME, RANK, AND TITLE JOHN H. SMITH, SFC, Training Supervisor	SIGNATURE /S/ JOHN H. SMITH
2 17 Aug 94 - PFC Doe DNIF (grounded) indefinitely due to High Blood Pressure Medication. Training Time stopped.	
NAME, RANK, AND TITLE JOHN H. SMITH, SFC, Training Supervisor	SIGNATURE /S/ JOHN H. SMITH
3 21 Oct 94 - PFC Doe FFD, training time resumed. TRNG time extension received. Estimated rating date adjusted to 15 Dec 94.	
NAME, RANK, AND TITLE JOHN H. SMITH, SFC, Training Supervisor	SIGNATURE /S/ JOHN H. SMITH
4 22 Oct 94 - JD received a "Needs Improvement" on Flight Strip Markings (FTM Chapter 8) during FD/GC proficiency evaluation. Although the overall evaluation was "SAT", #94-22, he will review FTM Chapter 8, retest and be re-evaluated on FD for proficiency. This training will be completed not later than 24 Oct 94.	
NAME, RANK, AND TITLE JOHN H. SMITH, SFC, Training Supervisor	SIGNATURE /S/ JOHN H. SMITH
5 24 Oct 94 - JD passed the exam for FTM Chapter 8 and received a Satisfactory evaluation #94-23 on FD.	
NAME, RANK, AND TITLE JOHN H. SMITH, SFC, Training Supervisor	SIGNATURE /S/ JOHN H. SMITH
6 12 Jan 95 - Annual Review - Reviewed FAAH 7110.65 w/chgs, LOAs, OPS Letters, AIGs, FM 1-303, ARs 40-8/40-501/95-2 and Facility Memorandums.	
NAME, RANK, AND TITLE JOHN H. SMITH, SFC, Training Supervisor	SIGNATURE /S/ JOHN H. SMITH
7 1 Apr 95 - SPC Doe DNIF for Medication, expected duration is 3 weeks.	
NAME, RANK, AND TITLE JOHN H. SMITH, SFC, Training Supervisor	SIGNATURE /S/ JOHN H. SMITH

DA FORM 3479-R, JUN 2003

6- _____
USAPA V1.00

Figure A-3. DA Form 3479-R Example (Continued)

SECTION VI - MISCELLANEOUS GENERAL COMMENTS	
<p>1 1 May 95 - JD FFD, did not meet currency requirements for the month of April due to leave and medical grounding</p>	
<p>NAME, RANK, AND TITLE JOHN H. SMITH, SFC, Training Supervisor</p>	<p>SIGNATURE /S/ JOHN H. SMITH</p>
<p>2 1 Sep 95 - JD did not meet currency requirements for the month of August. Received DA Form 3479-1-R for proficiency, # 95-02.</p>	
<p>NAME, RANK, AND TITLE JOHN H. SMITH, SFC, Training Supervisor</p>	<p>SIGNATURE /S/ JOHN H. SMITH</p>
<p>3 20 Dec 95 - RECORDS CLOSED. PCSing to Korea.</p>	
<p>NAME, RANK, AND TITLE JOHN H. SMITH, SFC, Training Supervisor</p>	<p>SIGNATURE /S/ JOHN H. SMITH</p>
<p>4 1 Feb 96 - SPC Doe assigned to Desiderio GCA. He has received his in-country up-slip, briefing on training program expectations, Training Time Limits, AR 95-2 and a general review of the FTM. He was issued a copy of the FTP, FTM and will keep "JD" as operating initials.</p>	
<p>NAME, RANK, AND TITLE THOMAS J. LYONS, SPC, Training Supervisor</p>	<p>SIGNATURE /S/ THOMAS J. LYONS</p>
<p>5 1 Jun 96 - SPC Doe returned from PLDC and granted a 2 month training extension. New rating end date 1 Aug 96. IAW QA SOP, he has been briefed on consequences should he fail to achieve his facility rating by this date.</p>	
<p>NAME, RANK, AND TITLE THOMAS J. LYONS, SPC, Training Supervisor</p>	<p>SIGNATURE /S/ THOMAS J. LYONS</p>
<p>6 30 Jul 96 - SPC Doe is assigned to the AN/TSQ-71B for cross-training. He has been briefed on his responsibility of maintaining currency in the fixed base GCA.</p>	
<p>NAME, RANK, AND TITLE THOMAS J. LYONS, SPC, Training Supervisor</p>	<p>SIGNATURE /S/ THOMAS J. LYONS</p>
<p>7 1 Dec 96 - SPC Doe is reassigned to Desiderio GCA. He has received his tactical rating on the 71B. TAC RECORDS CLOSED.</p>	
<p>NAME, RANK, AND TITLE THOMAS J. LYONS, SPC, Training Supervisor</p>	<p>SIGNATURE /S/ THOMAS J. LYONS</p>

DA FORM 3479-R, JUN 2003

6- 1
USAPA V1.00

Figure A-3. DA Form 3479-R Example (Continued)

SECTION VI - MISCELLANEOUS GENERAL COMMENTS	
1 24 Jan 97 - RECORDS CLOSED. PCSing to Hunter AAF, GA	
NAME, RANK, AND TITLE THOMAS J. LYONS, SPC, Training Supervisor	SIGNATURE /S/ THOMAS J. LYONS
2 1 Jul 00 - SSG Doe arrived to Korea from BNCOC, assigned to Guardian Control. He has received his in-country up-slip, briefing on training program expectations, training time limits, AR 95-2 and a general review of the FTM. Issued a copy of the FTP, FTM and assigned "JD" as operating initials.	
NAME, RANK, AND TITLE STAN TENTPEGS, SFC, Facility Chief, GC	SIGNATURE /S/ STAN TENTPEGS
3 28 Jul 00 - SSG Doe's training stopped. He is suspended from ATC duties due to positive urinalysis result. Soldier assigned to company headquarters pending investigation and Aeromedical Summary by local Flight Surgeon. ATCS Card confiscated.	
NAME, RANK, AND TITLE STAN TENTPEGS, SFC, Facility Chief, GC	SIGNATURE /S/ STAN TENTPEGS
4 1 Aug 00 - Aeromedical Summary complete. SSG Doe no longer qualified to hold MOS 93C. ATCS card returned to USAATCA for cancellation. Soldier reassigned to HHC, 164th ATS Group awaiting reclassification. RECORDS CLOSED.	
NAME, RANK, AND TITLE STAN TENTPEGS, SFC, Facility Chief, GC	SIGNATURE /S/ STAN TENTPEGS
5	
NAME, RANK, AND TITLE	SIGNATURE
6	
NAME, RANK, AND TITLE	SIGNATURE
7	
NAME, RANK, AND TITLE	SIGNATURE

DA FORM 3479-R, JUN 2003

6- 2
USAPA V1.00

Figure A-3. DA Form 3479-R Example (Continued)

SECTION VII - INDIVIDUAL RADAR RECORD										
* S/S = Supervised/Simulated *LV = Live Unsupervised/Non-Simulated										
YEAR:	PAR		ASR		EMERG/NO GYRO				GRAND TOTAL	REMARKS
					PAR		ASR			
	*S/S	*LV	*S/S	*LV	*S/S	*LV	*S/S	*LV		
January										
February										
March										
April										
May										
June										
July										
August										
September										
October										
November										
December										
Total Runs for Year										
Total Runs Brought Forward	40	63	7	14	5	5	10	13	157	
TOTAL Runs	40	63	7	14	5	5	10	13	157	
I have verified the runs brought forward are accurate.										
FACILITY CHIEF'S PRINTED NAME				FACILITY CHIEF'S SIGNATURE				DATE		
IAM D. MANN								16 Jun 03		

DA FORM 3479-R, JUN 2003

7- _____
USAPA V1.00

Figure A-3. DA Form 3479-R Example (Continued)

TACTICAL

TRAINING

RECORD

Figure A-3. DA Form 3479-R Example (Continued)

SECTION III - QUALIFICATION, PROFICIENCY, AND REMEDIAL TRAINING RECORD				
SUBJECT	TYPE	DATE	HOURS	REMARKS
Phase 1 Qualification	Q	15 Aug 96	127+30	
Introduction to AN/TSQ-71B	Q	30 Jul 96	2+00	See Section VI # 1 USAF
FTM Chap 1	Q	30 Jul 96	1+00	
Operate / PMCS M998	Q	9 Aug 96	2+00	
Operate / PMCS M35A2	Q	9 Aug 96	2+00	
Install / Operate / PMCS MJQ-39 15Kw	Q	9 Aug 96	2+00	
Install / Operate / PMCS PU-126	Q	9 Aug 96	1+00	
Install / Operate / PMCS AN/TSQ-71B	Q	4 Aug 96	21+30	
71B Shelter Turn On / Off Procedures	Q	4 Aug 96	1+30	
Shelter Emergency Shut-down Procedures	Q	4 Aug 96	10+00	
Disassembly/Storage of AN/TSQ-71B	Q	4 Aug 96	12+00	
Install / Operate / PMCS AN/TPN-18A	Q	5 Aug 96	1+00	
Radiation Hazard Briefing	Q	30 Jul 96	2+00	
AN/TPN-18A Turn On / Off Procedures	Q	5 Aug 96	1+00	
AN/TPN-18A Emergency Shut-down Procedures	Q	5 Aug 96	2+30	
Disassembly / Storage of AN/TPN-18A	Q	5 Aug 96	1+30	
Install / Operate / PMCS AN/TPX-44 (IFF)	Q	6 Aug 96	1+00	

DA FORM 3479-R, JUN 2003

3-
USAPA V1.00

Figure A-3. DA Form 3479-R Example (Continued)

SECTION III - QUALIFICATION, PROFICIENCY, AND REMEDIAL TRAINING RECORD				
SUBJECT	TYPE	DATE	HOURS	REMARKS
Recognized and ID ECM and ECCM	Q	23 Aug 96	3+00	
FAAH 7110.65 Chapter 2 thru 3	Q	25 Aug 96	6+00	
Interphone Procedures	Q	25 Aug 96	1+00	
Flight Check Procedures	Q	29 Aug 96	8+00	
FTM Chapter 5 thru 8	Q	3 Sep 96	1+00	
FM 1-303 Chapters 2 thru 4	Q	4 Sep 96	1+00	
Flips, Charts, VFR & IFR Supplements	Q	4 Sep 96	1+00	
FM 1-303 Chapters 5, 7 and 8	Q	4 Sep 96	1+30	
A2C2	Q	5 Sep 96	1+30	
Perform Assumption of Duty Requirements	Q	5 Sep 96	1+00	
Request, Record and Disseminate PIREPS	Q	5 Sep 96	1+00	
AR 40-8 and AIG Messages	Q	7 Sep 96	6+30	
AR 95-2 Chapters 2 thru 5	Q	7 Sep 96	1+00	
AR 40-501 Chapter 6	Q	7 Sep 96	1+00	
Flight Data Procedures	Q	8 Sep 96	18+00	PQ FD
FTM Chapter 9 thru 12	Q	10 Sep 96	7+00	
FAAH 7110.65 Chapter 5	Q	10 Sep 96	4+00	

DA FORM 3479-R, JUN 2003

3- 1

USAPA V1.00

Figure A-3. DA Form 3479-R Example (Continued)

SECTION III - QUALIFICATION, PROFICIENCY, AND REMEDIAL TRAINING RECORD				
SUBJECT	TYPE	DATE	HOURS	REMARKS
FAAH 7110.65 Chapters 7 & 10	Q	14 Sep 96	5+00	
Provide Radar Separation	Q	15 Sep 96	2+ 30	
PAR Lower Safety Limits	Q	15 Sep 96	3+00	IAW AIG 96-10
Operations in Simultaneous Mode	Q	15 Sep 96	12+ 30	
Provide Emergency Assistance	Q	16 Sep 96	2+ 30	
ASR/PAR Procedures	Q	18Sep 96	20+00	PQ
Pre-ATCS Exam	Q	19 Sep 96	2+00	
FTM Chap 13	Q	27 Sep 96	1+00	
-----RECORDS CLOSED-----	-----	-----1 DEC 96 ----	/S/	SNEEZY DWARF, SGT, USA Training Supervisor
Phase 1 Qualification	Q	18 Apr 97	37+00	
Introduction to AN/TSQ-97A	Q	12 Mar 97	1+00	
FTM Chapter 1	Q	12 Mar 97	1+00	
Operate / PMCS M998	Q	19 Mar 97	1+00	
MEP-025A 1.5Kw Generator	Q	19Mar 97	1+00	
Install / Operate / PMCS AN/TSQ-97A	Q	12 Mar 97	2+00	
Site Selection for AN/TSQ-97A	Q	12 Mar 97	1+00	
AN/TSQ-97A Turn On / Off Procedures	Q	12 Mar 97	1+00	

DA FORM 3479-R, JUN 2003

3- 2

USAPA V1.00

Figure A-3. DA Form 3479-R Example (Continued)

SECTION III - QUALIFICATION, PROFICIENCY, AND REMEDIAL TRAINING RECORD				
SUBJECT	TYPE	DATE	HOURS	REMARKS
AN/TSQ-97A Emergency Shut-down Procedures	Q	12 Mar 97	1+00	
Install AN/TSQ-97A Alternate Power Source	Q	13 Mar 97	1+00	
Disassembly / Storage of AN/TSQ-97A	Q	12 Mar 97	1+00	
Install / Operate / PMCS AN/TRN-30(v)1 Beacon	Q	13 Mar 97	2+00	15 Foot Mode
Disassembly / Storage of AN/TRN-30(v)1 Beacon	Q	13 Mar 97	1+00	
Prepare AN/TSQ-97A for Deployment	Q	12 Mar 97	1+00	
Prepare AN/TRN-30 for Deployment	Q	13 Mar 97	1+00	
Initial Weather Certification	Q	15 Mar 97	3+00	USAF
Intro to FM 3-52 (A2C2)	Q	15 Mar 97	1+00	
ANCD / KYK-13	Q	16 Mar 97	2+00	
Operate AN/PSN-11 (GPS)	Q	18 Mar 97	1+00	
Operate / PMCS (NVD) Night Vision Device	Q	18 Mar 97	3+00	
Introduction to FAAH 7110.65	Q	20 Mar 97	4+00	
Install Landing "Y" / NATO "T"	Q	23 Mar 97	2+00	
Determine Landing Direction	Q	23 Mar 97	1+00	
Phase 2 Rating	Q	20 Mar 97	191+00	
FTM Chapters 2 thru 4	Q	19 Apr 97	2+00	See Tac Section VI # 4

DA FORM 3479-R, JUN 2003

3- 3

USAPA V1.00

Figure A-3. DA Form 3479-R Example (Continued)

SECTION III - QUALIFICATION, PROFICIENCY, AND REMEDIAL TRAINING RECORD				
SUBJECT	TYPE	DATE	HOURS	REMARKS
Develop TAPS Report for NDB (AN/TRN-30)	Q	27 Mar 97	2+00	
Recognize and Implement ECM & ECCM	Q	28 Mar 97	1+00	
FAAH 7110.65 Chapters 2 thru 4	Q	28 Mar 97	3+00	
Interphone Procedures	Q	29 Mar 97	1+00	
FTM Chapters 5 thru 8	Q	19 Apr 97	2+00	
FM 1-303 Chapters 2 thru 4	Q	1 Apr 97	1+30	
Flips, Charts, VFR & IFR Supplements	Q	1 Apr 97	1+00	
FM 1-303 Chapters 6 thru 8	Q	3 Apr 97	2+00	
A2C2	Q	19 Apr 97	2+00	
Perform Assumption of Duty Requirements	Q	3 Apr 97	1+30	
Request, Record and Disseminate PIREPS	Q	4 Apr 97	1+00	
AR 40-8 and AIG Messages	Q	7 Apr 97	2+00	
AR 95-2 Chapters 2 thru 5	Q	7 Apr 97	1+30	
AR 40-501 Chapter 6	Q	7 Apr 97	0+30	
Process Flight Progress Strips	Q	20 Apr 97	2+00	
Interpret Crash Grid Map	Q	20 Apr 97	1+30	
Flight Data Procedures	Q	25 Apr 97	24+00	PQ FD

DA FORM 3479-R, JUN 2003

3- 4

USAPA V1.00

Figure A-3. DA Form 3479-R Example (Continued)

SECTION III - QUALIFICATION, PROFICIENCY, AND REMEDIAL TRAINING RECORD				
SUBJECT	TYPE	DATE	HOURS	REMARKS
FTM Chapter 9 & 12	Q	19 Apr 97	1+30	
FAAH 7110.65 Chapters 7 & 10	Q	8 Apr 97	1+30	
Control Aircraft Taxi	Q	28 Apr 97	1+30	
FARP Operations	Q	28 Apr 97	1+30	
Issue Airport / FARRP Condition Information	Q	28 Apr 97	0+30	
Light Gun Procedures	Q	9 Apr 97	1+30	
Provide Emergency Assistance	Q	29 Apr 97	1	
Ground Control Procedures	Q	29 Apr 97	63	PQ GC
Select Runway in Use	Q	30 Apr 97	1	
Provide Traffic Advisories	Q	30 Apr 97	1	
Control VFR / SVFR Aircraft	Q	15 May 97	1	
Flight Following Procedures	Q	17 May 97	2	
Local control Procedures	Q	18 May 97	60	PQ LC
Pre-ATCS Exam	Q	19 May 97	1	
FTM Chapter 13	Q	21 May 97	3	
FAAH 7110.65 Change 1	Q	1 Jun 97	4	
Install / Operate / PMCS AN/TSQ-97A	P	9 Aug 97	1+30	

DA FORM 3479-R, JUN 2003

3- 5

USAPA V1.00

Figure A-3. DA Form 3479-R Example (Continued)

SECTION III - QUALIFICATION, PROFICIENCY, AND REMEDIAL TRAINING RECORD				
SUBJECT	TYPE	DATE	HOURS	REMARKS
Install / Operate / PMCS AN/TRN-30(v)1 Beacon	P	17 Aug 97	2	
Issue Airport/FARP Condition Information	P	10 Sep 97	1	
FAAH 7110.65 Chapter 10	P	11 Sep 97	2	
FAAH 7110.65 Change 2	Q	21 Sep 97	3	
AIG Messages thru 97-10	Q	5 Oct 97	4	
DA Forms 2404, 2696-R, 3502-R & 3503-R	P	10 Oct 97	2+30	
AN/TSQ-97A ARTEP Procedures	P	14 Nov 97	7	
Understanding the Aviators Procedures Guide (APG)	P	12 Dec 97	1+30	
Phase 1 Qualification	Q	18 Apr 99	62	See Section VI # 6
Introduction to AN/TSW-7A	Q	13 Jan 98	2+30	
FTM Chapter 1	Q	13 Jan 98	2	
Operate / PMCS M1078 LMTV	Q	13 Jan 98	2+30	
Operate/PMCS 15Kw Generators	Q	13 Jan 98	2+30	
Install / Operate / PMCS An/TSW-7A	Q	15 Jan 98	16	
AN/TSW-7A Turn On / Off Procedures	Q	13 Jan 98	2	
Install AN/TSW-7A Modes 1, 2, & 3	Q	16 Jan 98	2	
Disassembly / Storage of AN/TSW-7A	Q	16 Jan 98	3+30	

DA FORM 3479-R, JUN 2003

3- 6

USAPA V1.00

Figure A-3. DA Form 3479-R Example (Continued)

SECTION III - QUALIFICATION, PROFICIENCY, AND REMEDIAL TRAINING RECORD				
SUBJECT	TYPE	DATE	HOURS	REMARKS
Install / Operate / PMCS ECU's	Q	16 Feb 99	2+00	
Operate AN/TSW-7A Under Unusual Conditions	Q	5 Mar 99	2+00	
Install / Operate / PMCS AN/TRN-30(v)1 Beacon	Q	10 Mar 99	4+00	15 & 30 Foot Configurations
Prepare AN/TSW-7A for Deployment	Q	13Mar 99	3+00	
Annual Weather Certification	P	10 Mar 99	3+00	USAF
Introduction to FM 3-52 (A2C2)	P	14 Jan 98	0+30	
ANCD / KYK-13	P	14 Jan 98	0+30	
Operate AN/PSN-11 (GPS)	P	14 Jan 98	0+30	
Operate / PMCS Night Vision Device (NVD)	P	14 Jan 98	0+30	
Introduction to FAAH 7110.65	P	14 Jan 98	0+30	
Install Landing "Y" / NATO "T"	P	14 Jan 98	0+30	
Phase 2 Rating	Q	30 Jan 98	80+00	
FTM Chapters 2 thru 4	Q	15 Jan 98	1+30	
Develop TAPS Report for NDB	Q	15 Jan 98	2+00	
FAAH 7110.65 Chapters 2 thru 4	P	14 Jan 98	2+30	
Recognize and Implement ECM & ECCM	P	14 Jan 98	0+30	
Request, Record and Disseminate PIREPS	P	14 Jan 98	0+30	

DA FORM 3479-R, JUN 2003

3- 7

USAPA V1.00

Figure A-3. DA Form 3479-R Example (Continued)

SECTION III - QUALIFICATION, PROFICIENCY, AND REMEDIAL TRAINING RECORD				
SUBJECT	TYPE	DATE	HOURS	REMARKS
Perform Assumption of Duty Requirements	Q	15 Jan 98	1+00	
Interphone Procedures	P	15 Jan 98	0+30	
FTM Chapters 5 thru 8	Q	15 Jan 98	1+00	
FM 1-303 Chapters 2 thru 4	P	16 Jan 98	1+00	
Flips, Charts, VFR & IFR Supplements	P	16 Jan 98	0+30	
FM 1-303 Chapters 6 thru 8	P	16 Jan 98	1+00	
A2C2	Q	14 Jan 98	1+00	
AR 40-8 and AIG Messages	P	17 Jan 98	2+00	
AR 95-2 Chapters 2 thru 5	P	17 Jan 98	1+00	
AR 40-501 Chapter 6	P	17 Jan 98	0+30	
Process Flight Progress Strips	P	17 Jan 98	1+00	
Interpret Crash Grid Map	P	17 Jan 98	0 +30	
Flight Data Procedures	P	18 Jan 98	37+00	PQ FD
FTM Chapters 9 & 12	Q	18 Jan 98	1+00	
FAAH 7110.65 Chapters 7 & 10	P	18 Jan 98	1+30	
Control Aircraft Taxi	P	18 Jan 98	0+30	
Issue Airport Condition Information	Q	20 Jan 98	1+00	

DA FORM 3479-R, JUN 2003

3- 8

USAPA V1.00

Figure A-3. DA Form 3479-R Example (Continued)

SECTION III - QUALIFICATION, PROFICIENCY, AND REMEDIAL TRAINING RECORD				
SUBJECT	TYPE	DATE	HOURS	REMARKS
Light Gun Procedures	Q	20 Jan 98	2 + 30	
Provide Emergency Assistance	Q	24 Jan 98	2	
Ground Control Procedures	Q	24 Jan 98	18	PQ GC
Select Runway in Use	P	25 Jan 98	2 + 30	
Provide Traffic Advisories	P	26 Jan 98	2 + 30	
Control VFR / SVFR Aircraft	P	26 Jan 98	2 + 30	
Flight Following Procedures	P	26 Jan 98	1	
Local Control Procedures	P	27 Jan 98	25	PQ LC
Pre-ATCS Exam	Q	29 Jan 98	1	
FTM Chapter 13	P	2 Jan 98	1	
Review AIG Messages thru 98-05	Q	17 Jul 98	5	
AIG Messages 98-06 & 98-07	Q	7 Oct 98	3	
Review Changes to AR 95-2	P	7 Oct 98	2	IAW AIG 98-07
Annual Weather Certification	P	7 Oct 98	2	USAF
Annual Weather Certification	P	6 Nov 99	3	USAF
-----RECORDS CLOSED-----	-----	-----1 FEB 00,---	/S/	IAM D. PLUTO, SSG, USA, Training Supervisor

DA FORM 3479-R, JUN 2003

3- 9

USAPA V1.00

Figure A-3. DA Form 3479-R Example (Continued)

SECTION IV - WRITTEN/ORAL/PRACTICAL TEST ACTION			
SUBJECT	DATE	SCORE	REMARKS
FTM Chap 1	30 Jul 96	SAT	
Operate/PMCS M998/	9 Aug 96	SAT	Practical/Hands-On Motor Sergeant
Operate/PMCS M35A2	9 Aug 96	SAT	Practical/Hands-On Motor Sergeant
Install/Operate/PMCS MJQ-15 15Kw Generator Set	9 Aug 96	SAT	Practical/Hands-On Motor Sergeant
Operate AN/PSN-11 (GPS)	2 Aug 96	SAT	Oral/Practical
Initial Weather Certification	29 Jul 96	SAT	USAF
Operate ANCD / KYK-13	2 Aug 96	SAT	Oral/Practical
Develop Reflector Layout Diagram	7 Aug 96	SAT	Oral/Practical
Determine Dial Divisions	8 Aug 96	SAT	Oral/Practical
Perform ASR/PAR Cursor Alignment	9 Aug 96	SAT	Oral/Practical
Phase 1 Qualification Exam	15 Aug 96	SAT	Written/Oral/Practical
Develop MVA Chart	20 Aug 96	SAT	Oral/Practical
FTM Chapters 2 thru 4	21 Aug 96	SAT	
FAAH 7110.65 Chap 2 & 3	25 Aug 96	SAT	
FTM Chapters 5 thru 8	3 Sep 96	SAT	
FM 1-303 Chapters 2 thru 4	4 Sep 96	SAT	
Flips, Charts, IFR/VFR Supplements	4 Sep 96	SAT	Practical

DA FORM 3479-R, JUN 2003

4- _____

USAPA V1.00

Figure A-3. DA Form 3479-R Example (Continued)

SECTION IV - WRITTEN/ORAL/PRACTICAL TEST ACTION			
SUBJECT	DATE	SCORE	REMARKS
AR 40-8 and AIG Messages	7 Sep 96	SAT	
AR 95-2 Chapters 2 thru 5	7 Sep 96	SAT	
Flight Data PQ Exam	8 Sep 96	SAT	Written/Oral/Practical
FTM Chapters 9 thru 12	10 Sep 96	SAT	
FAAH 7110.65 Chapter 5	10 Sep 96	SAT	
FAAH 7110.65 Chapters 7 & 10	14 Sep 96	SAT	
PAR Safety Limits	15 Sep 96	SAT	Oral/Practical
ASR/PAR PQ Exam	18 Sep 96	SAT	Written/Oral/Practical
Pre-ATCS Exam	19 Sep 96	SAT	
ATCS Exam	20 Sep 96	SAT	Written/Oral/Practical
FTM Chapter 13	27 Sep 96	SAT	Written/Oral/Practical
-----RECORDS CLOSED -----	---1 DEC 96,--	----- /S/-----	SNEEZY DWARF, SGT, USA, Training Supervisor
FTM Chapter 1	12 Mar 97	SAT	
Install/Operate AN/TSQ-97A	12 Mar 97	SAT	Oral/Practical
Install/Operate AN/TRN-30 (v) 1	13 Mar 97	SAT	Oral/Practical
Initial Weather Certification	15 Mar 97	SAT	USAF
Operate ANCD / KYK-13	16 mar 97	SAT	Oral/Practical

DA FORM 3479-R, JUN 2003

4- 1

USAPA V1.00

Figure A-3. DA Form 3479-R Example (Continued)

SECTION IV - WRITTEN/ORAL/PRACTICAL TEST ACTION			
SUBJECT	DATE	SCORE	REMARKS
FTM Chapters 2 thru 4	19 Apr 97	SAT	
Develop TAPS Report	27 Mar 97	SAT	Oral/Practical
FAAH 7110.65 Chapters 2 thru 4	28 Mar 97	SAT	
FTM Chapters 5 thru 8	19 Apr 97	SAT	
FM 1-303 Chapters 2 thru 4	1 Apr 97	SAT	
Flips, Charts, VFR & IFR Supplements	1 Apr 97	SAT	
FM 1-303 Chapters 6 thru 8	3 Apr 97	SAT	
AR 40-8 and AIG Messages	7 Apr 97	SAT	Oral
AR 95-2 Chapters 2 thru 5	7 Apr 97	SAT	
Process Flight Progress Strips	20 Apr 97	SAT	Oral/Practical
Interpret Crash Grid Map	20 Apr 97	SAT	Oral/Practical
Flight Data PQ Exam	25 Apr 97	SAT	Written/Oral/Practical
FTM Chapters 9 & 12	19 Apr 97	SAT	
FAAH 7110.65 Chap 7 & 10	8 Apr 97	SAT	
FARP Operations	28 Apr 97	SAT	Oral/Practical
Ground Control PQ Exam	29Apr 97	SAT	Written/Oral/Practical
Flight Following Procedures	17 May 97	SAT	Oral/Practical

DA FORM 3479-R, JUN 2003

4- 2

USAPA V1.00

Figure A-3. DA Form 3479-R Example (Continued)

SECTION IV - WRITTEN/ORAL/PRACTICAL TEST ACTION			
SUBJECT	DATE	SCORE	REMARKS
Local Control PQ Exam	18 May 97	SAT	Written/Oral/Practical
Pre-ATCS Exam	19 May 97	SAT	
ATCS Exam	20 May 97	SAT	Written/Oral/Practical
FTM Chapter 13	21 May 97	SAT	
Install/Operate/PMCS AN/TSQ-97A	9 Aug 97	SAT	Oral/Practical
AN/TSW-7A FTM Chapter 1	13 Jan 98	SAT	See Section VI # 6
Install/Operate AN/TSW-7A	15 Feb 99	SAT	Oral/Practical
Install AN/TRN-30 (v) 1	10 Mar 99	SAT	
Annual Weather Certification	10 Jan 98	SAT	USAF
Operate ANCD / KYK-13	14 Jan 98	SAT	Oral/Practical
Operate AN/PSN-11 (GPS)	14 Jan 98	SAT	Oral/Practical
Operate Night Vision Devices	14 Jan 98	SAT	Oral/Practical
Install Landing "Y" / NATO "T"	14 Jan 98	SAT	Oral/Practical
Phase 1 Qualification Exam	18 Apr 99	SAT	Written/Oral/Practical
FTM Chapters 2 thru 4	15 Jan 98	SAT	
Develop TAPS Report	15 Jan 98	SAT	Oral/Practical
FAAH 7110.65 Chapters 2 thru 4	14 Jan 98	SAT	

DA FORM 3479-R, JUN 2003

4 3

USAPA V1.00

Figure A-3. DA Form 3479-R Example (Continued)

SECTION IV - WRITTEN/ORAL/PRACTICAL TEST ACTION			
SUBJECT	DATE	SCORE	REMARKS
FTM Chapters 5 thru 8	15 Jan 98	SAT	Oral
FM 1-303 Chapters 2 thru 4	16 Jan 98	SAT	Oral
FM 1-303 Chapters 6 thru 8	16 Jan 98	SAT	Oral
AR 40-8 and AIG Messages	17 Jan 98	SAT	Oral
AR 95-2 Chapters 2 thru 5	17 Jan 98	SAT	Oral
Process Flight Progress Strips	17 Jan 98	SAT	Oral
Interpret Crash Grid Map	17 Jan 98	SAT	Oral/Practical
Flight Data PQ Exam	18 Jan 98	SAT	Written/Oral/Practical
FTM Chapters 9 & 12	18 Jan 98	SAT	Oral
FAAH 7110.65 Chapters 7 & 10	18 Jan 98	SAT	
Ground Control PQ Exam	24 Jan 98	SAT	Written/Oral/Practical
Flight Following Procedures	26 Jan 98	SAT	Oral/Practical
Local Control PQ Exam	27 Jan 98	SAT	Written/Oral/Practical
Pre-ATCS Exam	29 Jan 98	SAT	
ATCS Exam	30 Jan 98	SAT	See Section VI # 6 Written/Oral/Practical
FTM Chapter 13	2 Feb 98	SAT	
Install/Operate/PMCS AN/TSQ-97A	1 Jun 99	SAT	Oral/Practical

DA FORM 3479-R, JUN 2003

4- 4

USAPA V1.00

Figure A-3. DA Form 3479-R Example (Continued)

SECTION IV - WRITTEN/ORAL/PRACTICAL TEST ACTION			
SUBJECT	DATE	SCORE	REMARKS
Install/Operate/PMCS AN/TRN-30 (v) 1	12 Jun 99	SAT	15 and 30 foot configurations Oral/Practical
Develop TAPS Report	14 Jul 99	SAT	Oral/Practical
Prepare AN/TSQ-97A for Deployment	27 Sep 99	SAT	Oral/Practical
Annual Weather Certification	6 Nov 99	SAT	USAF
-----RECORDS CLOSED-----	---1 FEB 00 --	----- /S/-----	IAM D. PLUTO, SSG, USA, Training Supervisor

DA FORM 3479-R, JUN 2003

4- 5
USAPA V1.00

Figure A-3. DA Form 3479-R Example (Continued)

SECTION V - PROFICIENCY CHECKS						
POSITION	DATE	SCORE	HOURS	INITIALS		REMARKS
				ATC	SUPV	
71B FD	17 Aug 96	S	3+ 00	JD	RA	T96-01
71B FD	25 Aug 96	S	1+ 00	JD	SG	T96-02
71B FD	7 Sep 96	S	4+ 30	JD	RA	T96-03 PQ Recommend
71B FD	8 Sep 96	S	1+ 30	JD	DF	T96-04 PQ FD
71B ASR/PAR	15 Sep 96	S	4+ 30	JD	SG	T96-05
71B ASR/PAR	17 Sep 96	S	2+00	JD	RA	T96-06 PQ Recommend
71B ASR/PAR	18 Sep 96	S	7+00	JD	DF	T96-07 PQ ASR/PAR
71B FD/ASR/PAR	19 Sep 96	S	2+ 45	JD	RA	T96-08 Recommend Rating
71B FD/ASR/PAR	20 Sep 96	S	4+00	JD	DF	T96-09 AN/TSQ-71B
--RECORDS CLOSED----	-----1 DEC 96,---	----	-----	/S/	-----	SNEEZY DWARF, SGT, USA, Training Supervisor
97A FD	18 Apr 97	S	2+00	JD	TJ	T97-01
97A FD	18 Apr 97	S	1+00	JD	AP	T97-02 PQ Recommend
97A FD	25 Apr 97	S	2+ 30	JD	PO	T97-03 FD PQ
97A GC	29 Apr 97	S	6+ 30	JD	AP	T97-04 PQ Recommend
97A GC	29 Apr 97	S	4+ 30	JD	PO	T97-05 GC PQ
97A LC	3 May 97	S	3+00	JD	TJ	T97-06
97A LC	10 May 97	S	2+00	JD	AP	T97-07 PQ Recommend

DA FORM 3479-R, JUN 2003

5-
USAPA V1.00

Figure A-3. DA Form 3479-R Example (Continued)

SECTION V - PROFICIENCY CHECKS						
POSITION	DATE	SCORE	HOURS	INITIALS		REMARKS
				ATC	SUPV	
97A LC	18 May 97	S	7+00	JD	PO	T97-08 LC PQ
97A FD/GC/LC	19 May 97	S	2+00	JD	TJ	T97-09 Rating Recommend
97A FD/GC/LC	20 May 97	S	4+00	JD	PO	AN/TSQ-97A T97-10 ATCS
7A FD	18 Jan 98	S	4+00	JD	BM	T98-01 PQ Recommend
7A FD	18 Jan 98	S	2+30	JD	DK	T98-02 PQ FD
7A GC	24 Jan 98	S	5+30	JD	CN	T98-03 PQ Recommend
7A GC	24 Jan 98	S	1+30	JD	DK	T98-04 PQ GC
7A LC	25 Jan 98	S	8+00	JD	BM	T98-05
7A LC	27 Jan 98	S	3+00	JD	CN	T98-06 PQ Recommend
7A LC	27 Jan 98	S	4+45	JD	DK	T98-07 PQ LC
7A FD/GC/LC	29 Jan 98	S	4+00	JD	BM	T98-08 Rating Recommend
7A FD/GC/LC	30 Jan 98	S	6+00	JD	DK	AN/TSW-7A T98-09 ATCS
7A FD/GC/LC	18 Apr 99	S	4+00	JD	DK	T99-01 See Section VI # 8 Proficiency
97A FD/GC/LC	7 Jun 99	S	2+00	JD	PO	T99-02 Proficiency
---RECORDS CLOSED---	----1 FEB 00, ----	----	/S/	IAM	D.	PLUTO, SSG, USA, TRNG Supervisor

DA FORM 3479-R, JUN 2003

5- 1

USAPA V1.00

Figure A-3. DA Form 3479-R Example (Continued)

SECTION VI - MISCELLANEOUS GENERAL COMMENTS	
<p>1 30 Jul 96 - SPC Doe has been assigned to the AN/TSQ-71B (Tac GCA) for cross training. He has been briefed on training program expectations, Training Time Limits, AR 95-2 and a general review of the FTM. He was issued a FTP, FTM and will keep "JD" as operating initials. SPC Doe completed his Weather Certification on 29 Jul 96 with Tower personnel.</p>	
<p>NAME, RANK, AND TITLE SNEEZY DWARF, SGT, Training Supervisor</p>	<p>SIGNATURE /S/ SNEEZY DWARF</p>
<p>2 1 Dec 96 - SPC Doe is re-assigned to Desiderio GCA. Tactical RECORDS CLOSED.</p>	
<p>NAME, RANK, AND TITLE SNEEZY DWARF, SGT, Training Supervisor</p>	<p>SIGNATURE /S/ SNEEZY DWARF</p>
<p>3 12 Mar 97 - SPC Doe has received his up-slip 4186 and is assigned to the AN/TSQ-97A (Tac Team) section on this date. He has been briefed on training program expectations, Training Time Limits, AR 95-2 and a general review of the FTM. He was issued a FTP, FTM and assigned "JD" as operating initials.</p>	
<p>NAME, RANK, AND TITLE IAM D. PLUTO, SSG, Training Supervisor</p>	<p>SIGNATURE /S/ IAM D. PLUTO</p>
<p>4 16 Apr 97 - SGT Doe is deployed with the AN/TSQ-97A to JRTC. He will return on 20 May 97.</p>	
<p>NAME, RANK, AND TITLE IAM D. PLUTO, SSG, Training Supervisor</p>	<p>SIGNATURE /S/ IAM D. PLUTO</p>
<p>5 13 Jan 98 - SGT Doe is deploying to Bosnia as a member of the AN/TSW-7A tower team. Due to other training requirements he will not be able to complete Phase 1 prior to deployment. Expected date of return 15 Jan 99.</p>	
<p>NAME, RANK, AND TITLE DAFFY R. DUCK, SPC, Training Supervisor</p>	<p>SIGNATURE /S/ DAFFY R. DUCK</p>
<p>6 20 Jan 98 - Due to the AN/TSW-7A being emplaced prior to his arrival and no additional available assets, SGT Doe is unable to complete Phase 1 during deployment. He will continue with Phase 2 and complete rating. Phase 1 requirements will be completed upon return to home station. He will be re-evaluated for rating after Phase 1 completion using DA Form 3479-1-R.</p>	
<p>NAME, RANK, AND TITLE DAFFY R. DUCK, SPC, Training Supervisor</p>	<p>SIGNATURE /S/ DAFFY R. DUCK</p>
<p>7 17 Jan 99 - SGT Doe returned to Home station. He will continue training toward Phase 1 completion after His return from block leave.</p>	
<p>NAME, RANK, AND TITLE DAFFY R. DUCK, SPC, Training Supervisor</p>	<p>SIGNATURE /S/ DAFFY R. DUCK</p>

DA FORM 3479-R, JUN 2003

6- _____
USAPA V1.00

Figure A-3. DA Form 3479-R Example (Continued)

SECTION VI - MISCELLANEOUS GENERAL COMMENTS	
1 18 Apr 99 - SSG Doe has completed Phase 1 requirements for the AN/TSW-7A and is re-assigned to the Tac Team this date.	
NAME, RANK, AND TITLE IAM D. PLUTO, SSG, Training Supervisor	SIGNATURE /S/ IAM D. PLUTO
2 1 Feb 00 - SSG Doe is PCS'ing to Korea with BNCOC enroute. RECORDS CLOSED.	
NAME, RANK, AND TITLE IAM D. PLUTO, SSG, Training Supervisor	SIGNATURE /S/ IAM D. PLUTO
3	
NAME, RANK, AND TITLE	SIGNATURE
4	
NAME, RANK, AND TITLE	SIGNATURE
5	
NAME, RANK, AND TITLE	SIGNATURE
6	
NAME, RANK, AND TITLE	SIGNATURE
7	
NAME, RANK, AND TITLE	SIGNATURE

DA FORM 3479-R, JUN 2003

6- 1
 USAPA V1.00

Figure A-3. DA Form 3479-R Example (Continued)

SECTION VII - INDIVIDUAL RADAR RECORD										
* S/S = Supervised/Simulated					*LV = Live Unsupervised/Non-Simulated					
YEAR:	PAR		ASR		EMERG/NO GYRO				GRAND TOTAL	REMARKS
					PAR		ASR			
	*S/S	*LV	*S/S	*LV	*S/S	*LV	*S/S	*LV		
January										
February										
March										
April										
May										
June										
July										
August										
September										
October										
November										
December										
Total Runs for Year										
Total Runs Brought Forward	58	134	10	9	12	8	5	3	239	
TOTAL Runs	58	134	10	9	12	8	5	3	239	
I have verified the runs brought forward are accurate.										
FACILITY CHIEF'S PRINTED NAME					FACILITY CHIEF'S SIGNATURE					DATE
IAM D. MANN										16 Jun 03

DA FORM 3479-R, JUN 2003

7- _____

USAPA V1.00

Figure A-3. DA Form 3479-R Example (Continued)

SECTION III – ATC MAINTENANCE PERSONNEL CERTIFICATION AND RELATED TRAINING RECORD (DA FORM 3479-9-R) AND RESPONSIBILITY ASSIGNMENT (DA FORM 3479-10-R)

A-3. Instructions for completing and maintaining DA Form 3479-9-R and DA Form 3479-10-R can be found in chapter 8. Figures A-4 and A-5 provide an example of a completed Maintenance Certification Record.

ATC MAINTENANCE PERSONNEL CERTIFICATION AND RELATED TRAINING RECORD For use of this form, see FM 3-04.303; the proponent agency is TRADOC.								
1. NAME (last, first, MI) Jones, John H.			2. SSN 123-45-6789			3. GRADE/RANK SFC		
SECTION I. QUALIFICATION AND CERTIFICATION RECORD								
4. SYSTEM/ SUBSYSTEM/ EQUIPMENT	5. THEORY			6. PERFORMANCE			7. CERTIFICATION	
	a. Qual Meth ¹	b. Date Qual	c. Init	a. Qual Meth ¹	b. Date Qual	c. Init	a. Date Acquired ²	b. Date Revoked
AN/FSQ-84	EXP	15 Sep 94	SS	EXP	15 Sep 94	SS	15 Sep 94	
NDB-200	EXP	15 Sep 94	SS	EXP	15 Sep 94	SS	15 Sep 94	
ILS MARK 1F	NTRN	15 NOV 97	RM	RTRN	15 NOV 97	RM	15 NOV 97	
AN/FRN-41	CEXAM	20 FEB 98	RM	PEXAM	20 FEB 98	RM	20 FEB 98	
AN/TSQ-71B	CEXAM	20 OCT 98	VR	PEXAM	20 OCT 98	VR	20 OCT 98	
AN/TRN-30V 1&2	CEXAM	20 OCT 98	VR	PEXAM	20 OCT 98	VR	20 OCT 98	

Figure A-4. DA Form 3479-9-R Example

RESPONSIBILITY ASSIGNMENT						
For use of this form, see FM 3-04.303; the proponent agency is TRADOC.						
1. TYPE <input type="checkbox"/> Initial Assignment <input checked="" type="checkbox"/> Revision No. <u> 2 </u> <input type="checkbox"/> Revocation		2. DATE 25 NOV 98			3. PAGE NO. 1	
4. NAME (last, first, MI) JONES, JOHN H.			5. LOCATION F CO 1-58TH Avn Fort Hood, TX			
6. POSITION TITLE AND RANK/GRADE ATCSS Supervisor, SGT/E-5		7. IMMEDIATE SUPERVISOR SFC Rogers Victor A		8. LOCATION/PHONE NO. Fort Hood/737-0143		
NOTE: As recorded on DA Form 3479-9-R, you have demonstrated proficiency on the equipment listed below. You are hereby assigned maintenance and certification responsibility for this equipment. The kinds and levels of responsibility delegated to you are shown by the code designations, which are explained on the reverse side of this form. If you have any questions concerning these assignments or, for example, hours of duty, watch schedules, or crew chiefs, contact your immediate supervisor.						
9. SYSTEM/FACILITY/EQUIPMENT		10. RESPONSIBILITY		11. EFFECTIVE DATES		12. COMMENTS (If none, so state.)
		a. Maint	b. Cert	a. Start	b. End	
a. Type	b. Ident or Location					
TSQ-71B	Fort Hood	RWA	FC	25 Oct 98		None
TRN-30	Fort Hood	RWA	FC	25 Nov 98		None

Figure A-5. DA Form 3479-10-R Example

13. SPECIAL INSTRUCTIONS/RESTRICTIONS/LIMITATIONS/REMARKS			
14. I understand the nature and extent of the responsibilities listed on this document. NAME, TITLE, AND GRADE/RANK (typed) AND SIGNATURE OF TECHNICIAN Jones, John H., ATCSS supervisor, E5/SGT, Signature			
15. NAME AND TITLE (typed) AND SIGNATURE OF IMMEDIATE SUPERVISOR Rogers, Victor A., Maintenance NCOIC, Signature			
16. NAME AND TITLE (typed) AND SIGNATURE OF FACILITY MAINTENANCE CHIEF/35D BN CERTIFIER Rogers, Victor A., Company Certifier, Signature			
RESPONSIBILITY CODE DESIGNATIONS			
MAINTENANCE CBO Callback only; not regular workload. FIR Facility inspection responsibility. R-AST Regular workload assistance as assigned by supervisor. R-ASTCS Regular workload and/or callback as assigned by supervisor. RWA Regular workload assignments. RWCS Regular workload and callback responsibility. STAF Duties as assigned by the facility maintenance chief such as analytical, diagnostic, evaluation, major modification, inspection, relief, training and supervisory duties.			
CERTIFICATION FC Full certification for complete system. FIC Full installation certification. LC Limited certification; subject to listed limitations. SSC Subsystem certification; limited to listed equipment.			
17. COPY TO	<input checked="" type="checkbox"/> Technician	<input type="checkbox"/> Maintenance Supervisor	<input type="checkbox"/> Maintenance Chief
	<input type="checkbox"/> OTHER (Specify)	<input type="checkbox"/> FILE	

Figure A-5. DA Form 2479-10-R Example (Continued)

Appendix B

Publication Reference Files

ATC facilities use two types of reference files to support training and daily operations. A facility reference file is maintained in the office of the ATC chief/ATC SR SGT/PSG/ATC facility chief and in the company/platoon headquarters. (A single reference file may be used for dual facilities.) The controller reference file, which is maintained in the ATC facility, is readily available to the facility operating positions. The facility and controller reference files are explained in chapter 5. Table B-1 lists the publications that are required for both types (training and facility) of reference files. Table B-2 lists the required maintenance publications for installation and tactical facilities. An X in the reference file columns indicates that the publication is required.

Table B-1. Required ATC Reference Files										
<i>Publications</i>	Installation Facilities						Tactical Facilities			
	Towers and Stagefields		Radar		AIC		All Facilities		Co/Plt	A ² C ² LNOs
	FAC	CON	FAC	CON	FAC	CON	FAC	CON	HQs	
<i>Army Regulations</i>										
AR 25-50	X		X		X		X		X	
AR 25-55	X		X		X				X	
AR 25-400-2	X		X		X		X		X	
AR 40-8	X	X	X	X	X	X	X		X	
AR 40-501	X		X		X		X		X	
AR 95-2	X	X	X	X	X	X	X		X	
AR 385-10	X		X		X		X		X	
AR 385-95	X		X		X		X		X	
AR 420-90	X		X		X		X		X	
<i>Army Training And Evaluation Program (ARTEP) Manuals</i>										
ARTEP 1-425-MTP							X		X	
<i>DA Pamphlets</i>										
DA Pam 25-50	X		X		X				X	
DA Pam 738-750	X		X		X		X		X	
<i>DOD FLIPS (for applicable areas)</i>										
Low Altitude Instrument										
Approach Procedures	X	X	X	X	X	X	X	X	X	X
Charts	X	X	X	X	X	X	X	X	X	X
IFR Supplement	X	X	X	X	X	X	X	X	X	X
VFR Supplement	X	X	X	X	X	X	X	X	X	X

Table B-1. Required ATC Reference Files										
Publications	Installation Facilities						Tactical Facilities			
	Towers and Stagefields		Radar		AIC		All Facilities		Co/Plt	A²C² LNOs
	FAC	CON	FAC	CON	FAC	CON	FAC	CON	HQs	
FAA Publications										
FAAO 7110.65	X	X	X	X	X	X	X	X	X	X
FAAO 7210.3	X		X		X		X		X	
FAAO 7220.1	X	X	X	X	X	X	X		X	
FAAO 7340.1		X		X		X			X	
FAAO 7350.7	X		X		X				X	
FAAO 8200.1	X		X		X		X		X	X
FAAO 8260.3	X		X		X		X		X	X
Federal Aviation Regulations CONUS only										
FAR Part 65	X		X		X		X		X	
FAR Part 105	X		X		X		X		X	
Field Manuals										
FM 1-100							X		X	
FM 1-120	X	X	X	X	X	X	X	X	X	X
FM 3-04.303	X	X	X	X	X	X	X	X	X	X
FM 3-0									X	
FM 3-21.38							X		X	
FM 3-52							X	X	X	X
FM 3-100.2							X		X	X
FM 7-0*	X		X		X		X		X	
FM 100-103-2							X		X	X
FM 101-5									X	X
* Publications required only in those installation facilities with military personnel assigned.										
Joint Publications										
JP 3-52							X		X	X
ICAO Manual OCONUS only										
ICAO Manual 7910		X		X		X		X	X	
Technical Manuals										
UFC 3-260-01 (TM 5-803-7)	X		X				X		X	X

Table B-2. Required ATC Maintenance Reference Files				
Publications	Maintenance			
	Installation	Tactical Sections		
Army Regulations				
AR 25-400-2	X	X		
AR 70-1	X	X		
AR 95-1	X	X		
AR 95-2	X	X		
AR 385-10	X	X		
AR 385-95	X	X		
AR 420-90	X	X		
AR 700-138	X	X		
AR 710-2	X	X		
AR 725-50	X	X		
AR 735-5	X	X		
AR 750-1	X	X		
AR 750-43	X	X		
ARTEP Manuals				
ARTEP 1-425-MTP		X		
DA Pamphlets				
DA Pam 25-30	X	X		
DA Pam 710-2-1	X	X		
DA Pam 710-2-2	X	X		
DA Pam 738-750	X	X		
DA Pam 750-10	X	X		
DA Pam 750-35	X	X		
FAA Publications				
FAAO 6000.6	X	X		
FAAO 6000.15	X			
FAAO 6310.19 *	X			
FAAO 6360.1 *	X			
FAAO 6470.29 *	X			
FAAO 6480.6 *	X			
FAAO 6670.13 *	X			
FAAO 6700.20 *	X			
FAAO 6730.2 *	X			
FAAO 6740.2 *	X			
FAAO 6750.49 *	X			
FAAO 6770.2 *	X			
FAAO 6820.7 *	X			
FAAO 8020.11	X			
FAAO 8200.1	X	X		
* Required only at sites with systems listed in chapter 8.				

Table B-2. Required ATC Maintenance Reference Files				
Publications	Maintenance			
	Installation	Tactical Sections		
Field Manuals				
FM 1-120		X		
FM 3.04-303	X	X		
FM 9-43-1	X	X		
FM 10-27-4	X	X		
FM 11-486-23	X	X		
FM 11-487-4	X	X		
FM 11-490-9	X	X		
FM 21-11	X	X		
FM 22-100	X	X		
FM 24-2	X	X		
FM 25-100	X	X		
FM 25-101	X	X		
Supply Bulletin				
SB 11-573	X	X		
Technical Bulletins				
TB 11-6625-3263-25	X	X		
TB 43-0118	X	X		
TB 43-0129	X	X		
TB 43-0133	X	X		
TB 43-0180	X	X		
TB 385-4	X	X		
TB 750-25	X	X		
TB Med 523	X	X		
TB Sig 222	X	X		
Technical Manuals				
TM 5-803-7	X	X		
TM 5-811-3	X	X		
TM 5-811-5	X	X		
TM 5-823-4	X	X		
TM 9-6140-200-14	X	X		
TM 43-0139	X	X		

Appendix C

Facility Training Manuals

This appendix includes a detailed subject outline for an FTM that each facility develops and an abbreviated outline for a tactical facility FTM. These outlines cover indoctrination, equipment, responsibilities, and emergency equipment and notification procedures. They also cover local area information, reference material, coordination procedures, and facility administration and management. Facilities will use only the portions of these outlines that pertain to that specific facility.

Detailed Outline for an Installation Facility Training Manual

CHAPTER 1 INSTALLATION FACILITY INDOCTRINATION

1-1. MISSION

1-2. ATC FACILITY

- a. Operating hours and reporting time.
- b. Duty schedule.
- c. Preduty Requirements.
 - (1) Bulletin boards.
 - (2) Reading file.
 - (3) Equipment checks.
 - (4) Briefings.
- d. Duty requirements.
 - (1) Briefings.
 - (2) Facility cleanup.
- e. Training program.
 - (1) Description.
 - (2) Type (classroom, hands-on, and so forth).
 - (3) Written, oral, and practical exams.
 - (4) Training time limitation (AR 95-2).
 - (5) Facility training schedule.
- f. Controller reference file.
 - (1) Contents.
 - (2) Location.

- g. Facility reference file.
 - (1) Contents.
 - (2) Location.

1-3. GENERAL DESCRIPTION OF ASSOCIATED FACILITIES

- a. Weather.
- b. Base operations.
- c. Dispatch.
- d. Other ATC facilities.
- e. Range control.
- f. Fire station.
- g. Alert sections.

1-2. TRAINING RECORDS

- a. Use.
- b. Location.
- c. Access.

1-5. ELECTRONIC WARFARE TRAINING

- a. Threat briefing.
- b. Equipment vulnerabilities.
- c. Electronic countermeasures.
- d. Recognition of electronic countermeasures and appropriate Electronic counter-countermeasures.
- e. Meaconing, intrusion, jamming, and interference reporting.

1-6. FACILITY FORMS

**CHAPTER 2
AIR TRAFFIC CONTROL FACILITY EQUIPMENT**

2-1. RADIO COMMUNICATIONS EQUIPMENT

- a. Transmitters.
 - (1) Type.
 - (2) Location.
- b. Receivers.
 - (1) Type.
 - (2) Location.
- c. Frequencies.
- d. Channelization.
- e. Standby communications equipment.
- f. Secure voice operation.
- g. Maintenance and outage.

2-2. LAND-LINE COMMUNICATIONS EQUIPMENT

- a. Interphone.
 - (1) Type.
 - (2) Location.
 - (3) Use.

- (4) Circuit identification.
- (5) Maintenance and outage.
- b. Telephones.
- c. Intercommunications units.
 - (1) Type.
 - (2) Location.
 - (3) Use.
 - (4) Maintenance and outage.
- d. Weather dissemination.
 - (1) Type.
 - (2) Location.
 - (3) Use.
 - (4) Maintenance.
- e. Automation equipment.
 - (1) Type.
 - (2) Location.
 - (3) Use.
 - (4) Maintenance and outage.

2-3. RECORDING EQUIPMENT

- a. Type.
- b. Location.
- c. Positions/frequencies recorded.
- d. Tape change procedures.
- e. Playback.
- f. Maintenance and outage.

2-4. BRIGHT RADAR INDICATOR TOWER EQUIPMENT

- a. Operation and use.
- b. Automation procedures.

2-5. AIRFIELD/HELIPORT LIGHTING

- a. Control panel.
- b. Runway and helipad.
- c. Threshold.
- d. Boundary.
- e. Approach.
- f. Taxiway.
- g. Rotating beacon.
- h. Obstruction.
- i. Wind direction indicator.
- j. Spotlights.
- m. Maintenance and outage.
- n. Other.

2-6. MONITORING EQUIPMENT

- a. Equipment monitored.
- b. Operational checks.
- c. Maintenance checks.

2-7. AUTOMATIC TERMINAL INFORMATION SERVICE

- a. Use.
- b. Operational procedures.
- c. Message content and sequence.
- d. Maintenance and outage.

2-8. MISCELLANEOUS EQUIPMENT

- a. Light guns.
- b. Traffic counters.
- c. Binoculars.
- d. Wind instruments.
- e. Altimeters.
- f. Clocks.
 - (1) Time check.
 - (2) Setting procedure.
- g. First aid kits.
- h. Fire extinguisher.
- i. Fuse boxes.
- j. Heating and cooling equipment.
- k. Emergency power.
- l. Emergency egress system.
- m. Night vision devices.
- n. Maintenance and outages.

2-9. OPERATOR MAINTENANCE OF FACILITY EQUIPMENT

2-10. NOTICE TO AIRMEN

- a. Responsible agency.
- b. Equipment outages requiring a NOTAM.
- c. Controller action.

**CHAPTER 3
RESPONSIBILITIES**

3-1. OPERATING POSITIONS

- a. Control tower
 - (1) Flight data.
 - (2) Ground control.
 - (3) Local control.
 - (4) Clearance delivery.
 - (5) Approach control.
 - (6) Combined positions.
 - (7) Others.

- b. GCA.
 - (1) Feeder.
 - (2) Flight data.
 - (3) Final.
- c. ARAC.
 - (1) Flight data.
 - (2) Arrival.
 - (3) Departure.
 - (4) Precision approach radar.
 - (5) Other.
- d. AIC.
 - (1) Flight data.
 - (2) Flight-following control.
 - (3) Other.

3-2. SUPERVISORS

- a. Controller in charge.
- b. Shift leader.
- c. Training supervisor.
- d. Facility chief.
- e. ATC chief/ATC AR SGT.

CHAPTER 4 LOCAL AIRPORT/HELIPORT INFORMATION

4-1. AIRPORT/HELIPORT

- a. Responsible agency.
- b. Layout.
 - (1) Runways.
 - (a) Width.
 - (b) Length.
 - (c) Weight restrictions.
 - (d) Preferential runway.
 - (2) Other landing areas.
 - (3) Taxiways.
 - (a) Width.
 - (b) Weight restrictions.
 - (4) Ramp area.
 - (a) Hangar locations.
 - (b) Parking areas.
 - (c) Taxi restrictions.
 - (d) Servicing areas.
 - (5) Services available.
 - (6) Airport boundaries.
 - (7) Crash standby points.

4-2. TOWER VISIBILITY RESTRICTIONS

4-3. INSTRUMENT LANDING SYSTEM-CRITICAL AREAS

4-4. RADIO BLIND SPOTS

4-5. COMPASS ROSE

4-6. VOR RECEIVER CHECKPOINTS

4-7. AIRPORT/HELIPORT OBSTRUCTIONS

- a. Bearing.
- b. Height.
- c. Distance.

4-8. TRAFFIC PATTERNS

4-9. VISUAL FLIGHT RULES REPORTING POINTS

- a. Bearing.
- b. Distance.

4-10. SPECIAL VISUAL FLIGHT RULES

- a. Minimums.
- b. Routes.
- c. Reporting points.

4-11. LOCAL AIRPORT/HELIPORT RULES AND REGULATIONS

- a. Taxi regulations.
- b. Terminal procedures.
 - (1) Medical evacuation.
 - (2) Night vision devices.
 - (3) Very important persons.
 - (4) Hot refueling.
 - (5) Aircraft types and call signs.
- c. Hazardous cargo.
- d. Emergency equipment location.
- e. Restricted aircraft movement.
- f. Airfield security.
- g. Noise abatement.
- h. Launch and recovery procedures.
- i. Autorotation.
 - (1) Procedures.
 - (2) Areas.

4-12. AIRCRAFT OPERATIONS

- a. Scheduled air carriers.
- b. Nonscheduled operations.
- c. Military operations.
- d. General aviation operations.

4-13. WEATHER REPORTING PROCEDURES

- a. Responsible agency.
- b. Visibility checkpoints.
 - (1) Day.
 - (a) Bearing.
 - (b) Distance.
 - (2) Night.
 - (a) Bearing.
 - (b) Distance.
- c. Nearest weather reporting facilities.
- d. Pilot reports.
- e. Weather warnings.
- f. High-wind plan.

4-14. UNAUTHORIZED PERSONNEL AND VEHICLES

- a. Reporting.
- b. Recording Incidents.

CHAPTER 5

EMERGENCY EQUIPMENT AND NOTIFICATION PROCEDURES

5-1. AVAILABLE EQUIPMENT

- a. Ambulance.
- b. Fire fighting equipment.
- c. Rescue equipment.
 - (1) Helicopter.
 - (2) Other.

5-2. EMERGENCY NOTIFICATION PROCEDURES

- a. Controllers.
 - (1) Position responsibilities.
 - (2) Closing and opening the airfield.
 - (3) Foaming runways.
 - (4) Required reports.
- b. Firefighting personnel and equipment.
- c. Medical personnel and equipment.
- d. Military police.

5-3. INCIDENTS AND ACCIDENTS

- a. On-the-Airfield.
- b. Off-the-Airfield.
- c. Information Sources.
- d. Primary Reporting Procedures.
- e. Format and Recording of Reports.

CHAPTER 6
LOCAL AREA INFORMATION

- 6-1. *CLASS 'C' AIRSPACE (RADAR)*
 - a. Boundaries.
 - b. Adjacent areas.
 - c. Altitudes.
 - d. Airways.
- 6-2. *CLASS 'D/E/G' AIRSPACE*
 - a. Dimensions and description.
 - b. Adjacent class 'B/C/D/E' airspace.
- 6-3. *SURFACE AREA*
 - a. Boundaries.
 - b. Users.
- 6-4. *NAVIGATIONAL AIDS*
 - a. Type.
 - b. Location.
 - c. Identification.
 - d. Airways.
- 6-5. *PROMINENT OBJECTS AND OBSTRUCTIONS*
 - a. Bearing.
 - b. Height.
 - c. Distance.
- 6-6. *SPECIAL USE AIRSPACE*
 - a. Location.
 - (1) Boundaries.
 - (2) Altitudes.
 - (3) Times.
 - (4) Controlling agency.
 - b. Use.
 - c. Remotely piloted vehicles/unmanned aerial vehicles.
 - (1) Area.
 - (2) Procedure.
 - d. Nap-of-the-earth.
 - e. Night vision devices.
 - (1) Area.
 - (2) Procedure.
 - f. IFR/VFR corridors.
 - g. Airstrips.
 - (1) Location.
 - (2) Use.

6-7. *VFR TRAINING AREAS*

6-8. *ADJACENT AIRPORTS/HELIPORTS*

6-9. *PARACHUTE AREAS*

**CHAPTER 7
LETTERS, MEMORANDA, REPORTS, AND FORMS**

7-1. *LETTERS OF AGREEMENT*

- a. Agencies.
- b. General content.

7-2. *OPERATIONS LETTERS*

- a. Agencies.
- b. General content.

7-3. *FACILITY MEMORANDA*

7-4. *OPERATIONAL HAZARD REPORTS*

- a. Preparation.
- b. Submission.

**CHAPTER 8
FLIGHT PLANS, STRIPS, AND MARKINGS**

8-1. *FLIGHT PLANS*

- a. Types.
- b. Requirements.
- c. Local filing.
- d. In-flight filing.
- e. Action upon receipt.
 - (1) IFR.
 - (2) VFR.
 - (3) SVFR.
- f. Procedures.
 - (1) Forwarding information.
 - (2) Flight plan changes (IFR to VFR).

8-2. *FLIGHT STRIPS*

- a. Marking.
- b. Retention.

**CHAPTER 9
INSTRUMENT FLIGHT RULES AND COORDINATION PROCEDURES**

9-1. *APPROACH PROCEDURES*

- a. Initial approach altitudes.
- b. Holding patterns.
 - (1) Location.
 - (2) Description.

- c. Procedure turn.
- d. Final approach altitude and heading.
- e. Release points.
- f. Missed-approach procedures.
- g. Weather minimums.

9-2. DEPARTURE PROCEDURES

- a. Routes.
 - (1) DPs.
 - (2) Transitions.
- b. Altitudes Between Fixes and Intersections.
 - (1) Normal assigned frequencies.
 - (2) Minimum en route altitudes.

9-3. COORDINATION PROCEDURES

- a. Interposition.
- b. Local facilities.
- c. ARTCC.
- d. Adjacent airports.

9-4. INADVERTANT IMC

9-5. MULTIPLE EMERGENCY HAND-OFF PROCEDURES

- a. Frequency Management.
- b. Coordination.
- c. Abbreviated (short) approaches.
- d. Sequencing and separation standards.

**CHAPTER 10
SECONDARY RADAR**

10-1. COMPONENTS

- a. Interrogator.
- b. Transponder.
- c. Decoder.

10-2. TYPE OF EQUIPMENT (AN/TPX-41 AND ATCBI-3)

10-3. PRESENTATIONS

- a. Factors.
 - (1) Line-of-sight.
 - (2) Aircraft altitude.
 - (3) Reflections.
 - (4) Resolution.
 - (5) Ring-around.
 - (6) Slant-range.
- b. Interface.
- c. Others.

10-4. CODE ASSIGNMENTS

- a. Facility.
- b. Adjacent facilities.
- c. Emergency.

**CHAPTER 11
RADAR**

11-1. EQUIPMENT

- a. Type.
- b. Display.
- c. Alignment and adjustment.
- d. Characteristics.
- e. Keyboard.
- f. Computer.
- g. Radar coverage.
- h. Simulators.

11-2. MINIMA

- a. MVA.
- b. MSA.
- c. MRA.
- d. SVFR.

11-3. USE

Note: This paragraph was left blank intentionally. The ATC chief/ATC SR SGT/ATC facility chief may use it to expound on, or refer to, radar use, services, separation, sequencing, and phraseology contained in FAA Handbook 7110.65. All Army radar controllers are required to know and use the applicable radar procedures in the handbook. For purposes of testing, training, proficiency, and record keeping, FAA Handbook 7110.65, chapter 5 shall be considered an extension of this manual.

**CHAPTER 12
FACILITY ADMINISTRATION**

12-1. DAILY ADMINISTRATION

- a. Compiling traffic count.
- b. Recording traffic count.
- c. Maintaining facility forms and records.
- d. Filing facility forms and records.

12-2. STORING OF RECORDS

- a. Labels.
- b. Storage area.
- c. Retention.

12-3. DISSEMINATION OF INFORMATION

- a. Accidents and incidents.
- b. Numbers and types of aircraft.
- c. Types and capabilities of equipment.
- d. Personnel.
- e. Operations.
- f. Others.

CHAPTER 13
ATC MANAGEMENT TRAINING

13-1. ADMINISTRATION

13-2. FACILITY REPORTS

13-3. OPERATIONAL HAZARD REPORTS

13-4. ACCIDENTS OR INCIDENTS

13-5. FLIGHT INSPECTION PROCEDURES

13-6. TRAINING RECORDS AND TRAINING PROGRAMS

13-7. ADMINISTRATION OF FACILITY QUALIFICATION AND RATING PROGRAM

13-8. ARMY REGULATIONS

13-9. OPERATIONS LETTERS, LETTERS OF AGREEMENT, AND FACILITY MEMORANDA

Abbreviated Outline For A Tactical Facility Training Manual

CHAPTER 1 TACTICAL FACILITY INDOCTRINATION

- 1-1. *MISSION*
- 1-2. *FACILITIES*
- 1-3. *GENERAL DESCRIPTION OF ASSOCIATED OR SUPPORTED UNITS*
- 1-4. *TRAINING RECORDS*
- 1-5. *ELECTRONIC WARFARE TRAINING*
- 1-6. *DA FORM 3501-R, DA FORM 3502-R, AND DA FORM 3503-R*

CHAPTER 2 AIR TRAFFIC CONTROL FACILITY EQUIPMENT

- 2-1. *RADIO COMMUNICATIONS EQUIPMENT*
- 2-2. *LAND-LINE COMMUNICATIONS EQUIPMENT*
- 2-3. *POWER GENERATION EQUIPMENT*
- 2-4. *NAVIGATIONAL EQUIPMENT*
- 2-5. *AIRFIELD/HELIPORT LIGHTING*
- 2-6. *MISCELLANEOUS EQUIPMENT*
- 2-7. *EQUIPMENT MAINTENANCE*

CHAPTER 3 RESPONSIBILITIES

- 3-1. *CONTROL TOWER (7A, 70A, OR AN/MSQ-135)*
- 3-2. *TACTICAL TEAM (TTCS)*
- 3-3. *GCA TEAM (71B OR ATNAVICS)*
- 3-4. *FLIGHT FOLLOWING (61B OR TAIS)*
- 3-5. *SUPERVISOR*

CHAPTER 4 LOCAL AIRFIELD/HELIPORT AND AREA INFORMATION

- 4-1. *AIRFIELD/HELIPORT LOCATION*
- 4-2. *VISIBILITY RESTRICTIONS*
- 4-3. *RADIO RESTRICTIONS*
- 4-4. *AIRFIELD/HELIPORT OBSTRUCTIONS*
- 4-5. *TRAFFIC PATTERNS*
- 4-6. *VFR REPORTING POINTS*

4-7. *LOCAL RULES AND REGULATIONS*

4-8. *WEATHER REPORTING PROCEDURES*

**CHAPTER 5
EMERGENCY EQUIPMENT AND NOTIFICATION PROCEDURES**

5-1. *AVAILABLE EQUIPMENT*

5-2. *EMERGENCY NOTIFICATION PROCEDURES*

5-3. *FACILITY ACTIONS*

5-4. *INCIDENTS AND ACCIDENTS*

**CHAPTER 6
LOCAL AREA INFORMATION**

6-1. *CLASS B/C/D/E AIRSPACE*

6-2. *ADJACENT CLASS B/C/D/E AIRSPACE*

6-3. *NAVIGATIONAL AIDS*

6-4. *PROMINENT OBSTRUCTIONS*

6-5. *RESTRICTED AND PROHIBITED AREAS*

6-6. *ADJACENT AIRFIELDS/HELIPORTS*

**CHAPTER 7
LETTERS, MEMORANDA, REPORTS, AND FORMS**

7-1. *LETTERS OF AGREEMENT*

7-2. *OPERATIONS LETTERS*

7-3. *FACILITY MEMORANDA*

7-4. *OPERATIONAL HAZARD REPORTS*

**CHAPTER 8
FLIGHT PLANS, STRIPS, AND MARKINGS**

8-1. *FLIGHT PLANS*

8-2. *FLIGHT STRIPS AND MARKINGS*

**CHAPTER 9
INSTRUMENT FLIGHT RULES AND COORDINATION PROCEDURES**

9-1. *APPROACH PROCEDURES*

9-2. *DEPARTURE PROCEDURES*

9-3. *COORDINATION PROCEDURES*

9-4. *VERTICAL HELICOPTER IFR RECOVERY PROCEDURES*

9-5. *MULTIPLE EMERGENCIES HANDOFF PROCEDURES, FREQUENCY MANAGEMENT, COORDINATION PROCEDURES, ABBREVIATED (SHORT) APPROACHES, AND SEQUENCING AND SEPARATION STANDARDS.*

**CHAPTER 10
SECONDARY RADAR**

- 10-1. COMPONENTS*
- 10-2. TYPE OF EQUIPMENT*
- 10-3. CODE ASSIGNMENT*

**CHAPTER 11
RADAR**

- 11-1. EQUIPMENT*
- 11-2. MINIMA*
- 11-3. USE*

**CHAPTER 12
FACILITY ADMINISTRATION**

- 12-1. FACILITY OPERATING FORMS*
- 12-2. STORING OF RECORDS*
- 12-3. DISSEMINATION OF INFORMATION*

**CHAPTER 13
ATC MANAGEMENT TRAINING**

- 13-1. ADMINISTRATION*
- 13-2. FACILITY REPORTS*
- 13-3. OPERATIONAL HAZARD REPORTS*
- 13-4. ACCIDENTS AND INCIDENTS*
- 13-5. FLIGHT INSPECTION PROCEDURES*
- 13-6. TRAINING RECORDS AND TRAINING PROGRAMS*
- 13-7. ADMINISTRATION OF FACILITY QUALIFICATION AND RATING PROGRAM*
- 13-8. ARMY REGULATIONS*
- 13-9. OPERATIONS LETTERS, LETTERS OF AGREEMENT, AND FACILITY MENORANDA*
- 13-10. TERPS*

Appendix D

Theodolite Operations

The accuracy of Theodolite measurements depends on the proper care, setup, and adjustment of the instrument. Personnel must be careful when removing the Theodolite from its carrying case and mounting it onto the tripod. This appendix explains the correct procedures for setting up, leveling, adjusting, positioning, and orienting the Theodolite. It also includes flight check commissioning factors and preventive maintenance measures. Figure D-1 illustrates the components of the Theodolite (model 20-8400).

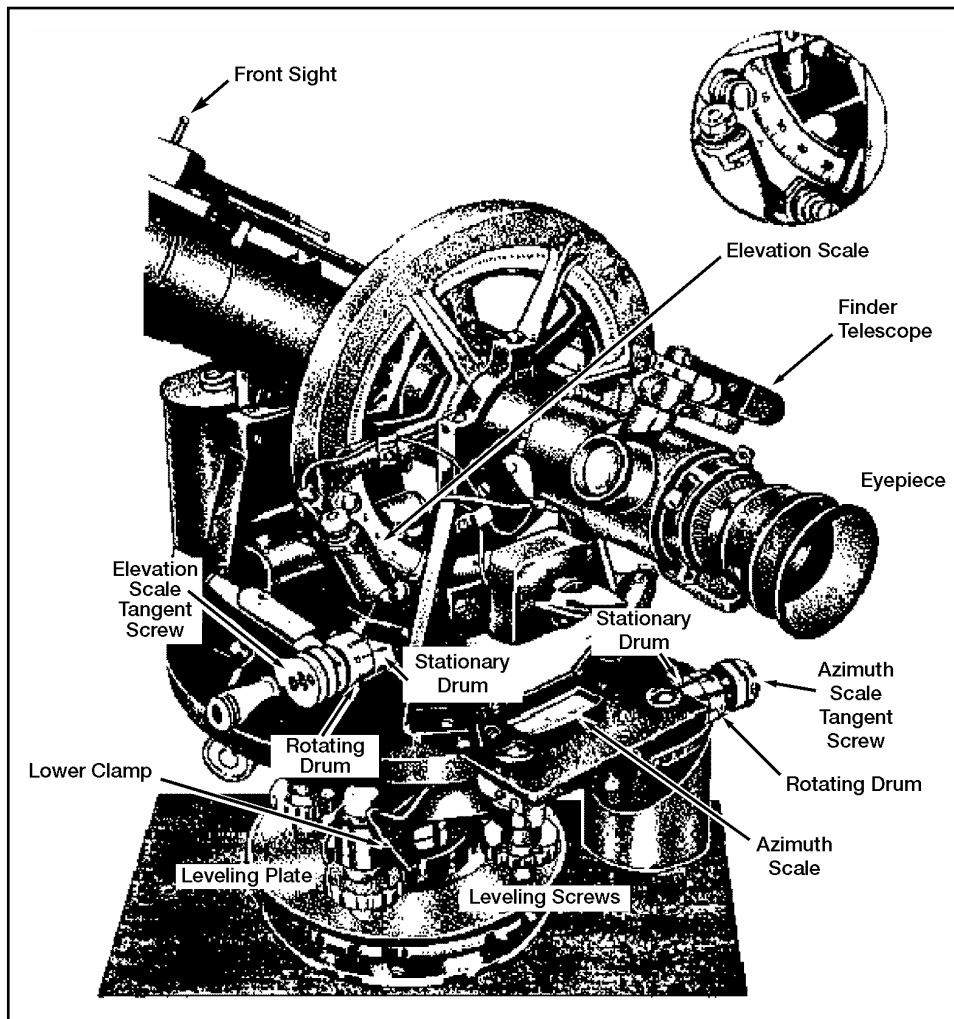

Figure D-1. Theodolite Components

SETUP

REMOVAL FROM THE CARRYING CASE

D-1. To remove the Theodolite from its carrying case, use the following steps. (Refer to paragraph D-22 for instructions on replacing the instrument in the case.)

Step 1. Place both hands under the base plate (the part containing the azimuth scale), and slide the instrument out of its case.

Step 2. With one hand (reaching from above), grasp the two adjacent leveling screws at the narrow part of the column and cradle the instrument carefully against your body with your forearm.

Step 3. With the other hand, unscrew the baseboard.

MOUNTING ONTO THE TRIPOD

Note: When mounting the Theodolite onto the tripod, do not turn the Theodolite by the upper part when the azimuth tangent screw is engaged; this may cause damage to the threads.

Step 1. With both hands on the column, carefully screw the instrument onto the tripod head.

Step 2. Remove the dust cap, and install the sunshade onto the telescope.

Step 3. Screw the tripod cap onto the baseboard, replace the baseboard in the carrying case, and close the door.

LEVELING

D-2. Preparation for Leveling.

Note: Steps 2 through 4 may be omitted if the Theodolite is not positioned over a point such as a marker stake or bench marker.

Step 1. If the Theodolite is to be located over a point such as a marker stake, suspend the plumb bob by its string from the eye accessible through the hole in the bottom of the leveling plate.

Step 2. Keeping the Theodolite approximately level (as gauged by the eye), center the plumb bob over the marker by moving tripod legs.

Step 3. Accurately center the plumb bob over the marker by loosening the two adjacent leveling screws and shifting the instrument laterally by moving its shifting plate. If this moves the Theodolite too near the edge of the base plate, reposition the tripod legs.

Step 4. Ensure that the Theodolite is approximately level (as gauged by the eye).

Step 5. Disengage the elevation scale tangent screw by pushing it down.

Step 6. Point the telescope straight up.

Step 7. Reengage the elevation scale tangent screw by pushing it up.

Step 8. Lower the battery box to provide a better view of bubble levels.

Step 9. Disengage the azimuth scale tangent screw by pulling it out.

Step 10. Set the horizontal azimuth scale to zero degrees.

Step 11. Reengage the azimuth scale tangent screw by pushing it in.

Step 12. Loosen the lower clamp.

Step 13. Loosen the leveling screws slightly, and slide the instrument until it is centered or until the plumb bob (if used) is exactly over the marked observation point; then retighten the leveling screws.

Step 14. Rotate the instrument so each bubble level is parallel to a diagonally opposite pair of leveling screws, then retighten the lower clamp.

D-3. Procedures for Leveling.

Note: The proper Theodolite level is indicated when leveling bubbles are centered and their ends are an equal distance from the corresponding graduation marks.

Step 1. Using both hands, grasp one pair of diagonally opposite leveling screws between the thumbs and forefingers.

Step 2. With a smooth and steady motion, turn the screws simultaneously so your thumbs move either toward or away from each other. This ensures that the screws are tightened or loosened an equal amount. The bubble will move in the same direction as your left thumb.

Note: Do not loosen any screw to a point that will allow the instrument to wobble on the mount.

Step 3. Using the technique in the previous steps 1 and 2, bring one bubble near the center. Then move to the opposite pair of leveling screws and bring the other bubble near the center. The bubble levels should now be nearly centered, and all leveling screws should be fairly snug.

Step 4. To center the bubbles exactly, carefully adjust one screw (of a pair), alternating pairs until both bubbles are exactly centered. All leveling screws should be firm and both bubbles centered.

Step 5. Disengage the azimuth scale tangent screw, and rotate the instrument to exactly 180 degrees. If the bubbles remain centered, the instrument is level.

Step 6. If the bubbles are slightly off center, center them again using the technique in step 4.

Step 7. Rotate the instrument to zero degrees.

Note: If the bubbles are centered, the instrument is level. If the bubbles are off center, a vertical axis adjustment is required. Refer to paragraph D-12 for this major adjustment procedure.

MINOR ADJUSTMENTS

CAUTION

Never sight the Theodolite on the sun without using the special sun filter. The concentration afforded by the telescope can easily cause damage to the eye.

Focusing

D-4. If personnel who normally wear eyeglasses can remove them during Theodolite operations, they will obtain a greater field of view. They should choose a distant, preferably indistinct, object to make focus comparisons with and without eyeglasses. They should completely refocus the instrument each time. Figure D-2 shows a cutaway view of the Theodolite optical system.

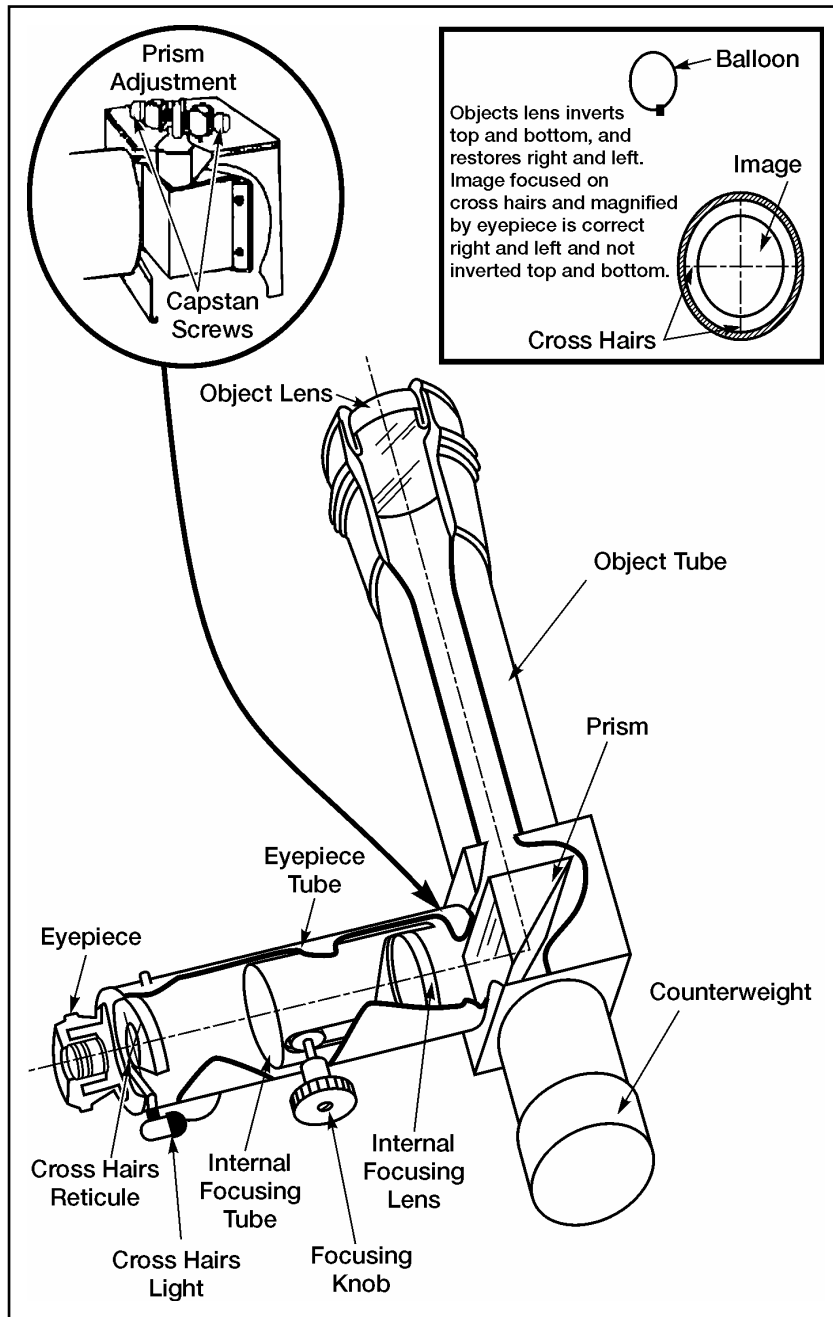

Figure D-2. Cutaway View of the Theodolite Optical System

Cross-Hair Focusing

D-5. Sight through the eyepiece with the telescope pointed toward the sky, and bring the cross hairs into focus by rotating the eyepiece by hand until the cross hairs are seen with maximum sharpness.

Telescope Focusing

D-6. Sight on an object at least 100 feet away, and focus on it by turning the knurled knob until the object is clear and distinct.

Note: If an aircraft is to be picked up at some distance inbound, focus on a distant object on the horizon. Check the focus by moving the head slightly from side to side or up and down, while peering into the eyepiece. Focusing is correct when the cross hairs do not appear to move across the field of the telescope.

CHECKING FOR THE CORRECTING BACKLASH

Checking for Backlash

D-7. Sight the cross hairs on a target about 1,500 feet away or farther. With the tangent screws engaged, rotate the tangent screws slowly back and forth, one at a time, while looking at the target through the telescope. If a tangent screw can be rotated without a corresponding movement of the cross hairs on the target, backlash is present.

Correcting Backlash

D-8. Refer to higher echelon maintenance.

CHECKING FOR AND CORRECTING MESH

Checking for Proper Mesh

D-9. While watching the elevation scale, lift the elevation tangent screw against the vertical scale ring gear. If mesh is proper, there should be no movement of the vertical scale. Improper mesh of the azimuth tangent screw will cause binding and undue wear.

Correcting Improper Mesh

D-10. Refer to higher echelon maintenance.

Note: The tangent screw fiducial marks on the stationary drum should be visible when your eye is at the eyepiece position. The spacing should be as close as possible without touching.

ADJUSTING DRUMS

D-11. Refer to higher echelon maintenance.

MAJOR ADJUSTMENTS

Vertical Axis Adjustment

D-12. The vertical axis is the axis of horizontal rotation of the base plate and, consequently, of the telescope. The purpose of this adjustment is to make the axis of each bubble level perpendicular to the vertical axis of the Theodolite. That is, it makes the axis of each level exactly parallel with the plane of the base plate. When the adjustment has been properly completed, the bubble in each level will remain centered during a complete horizontal rotation of the instrument and the axis of that rotation will be vertical. Each time the

Theodolite is set up, the vertical axis adjustment should be checked and, if necessary, the adjustment made. Figure D-3 shows the vertical axis adjustment.

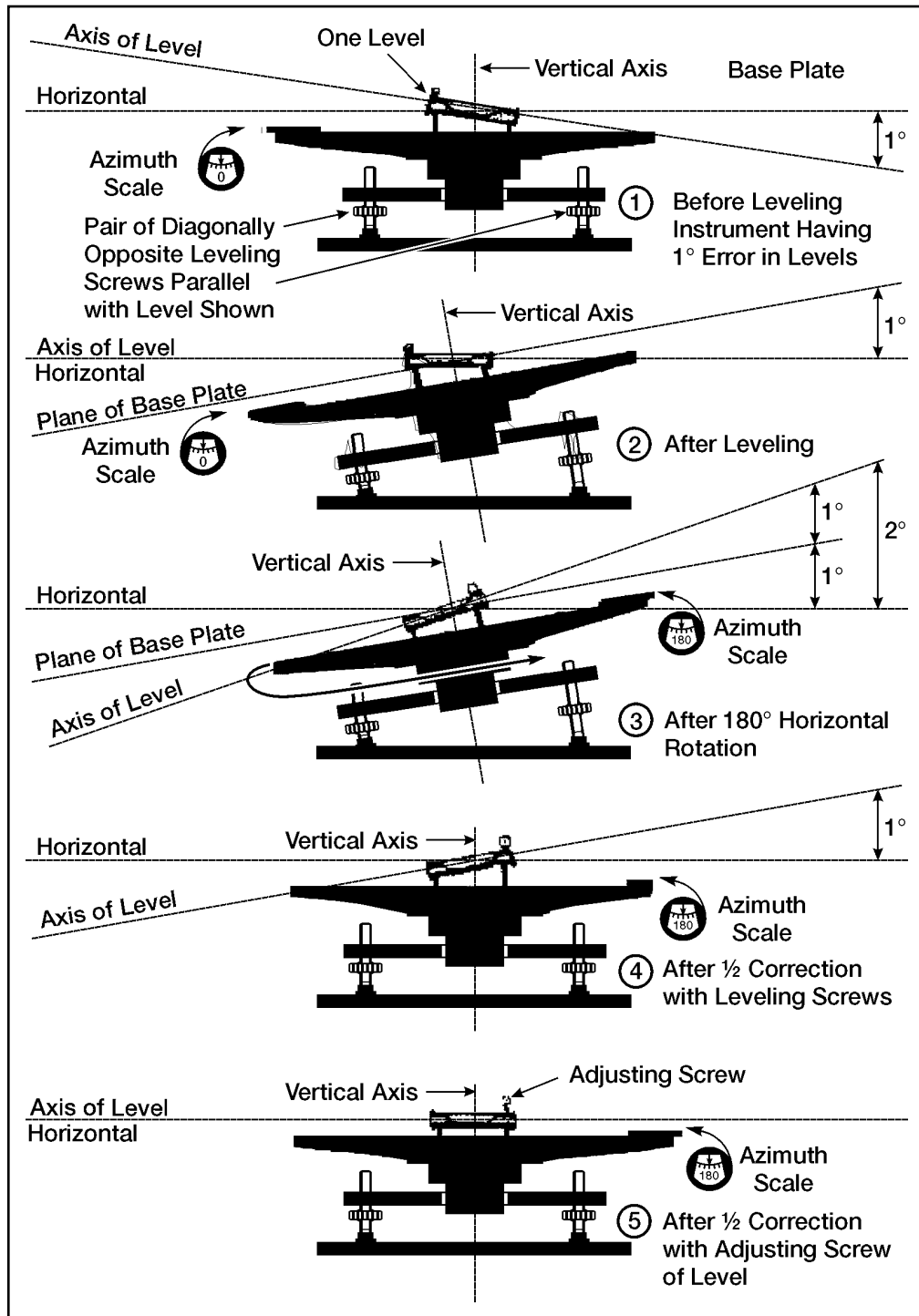

Figure D-3. Vertical Axis Adjustment

CAUTION

The vertical axis adjustment is a complex procedure that should be performed only by operators who know how to correctly make the adjustment.

Step 1. Set the azimuth scale at zero degrees, and leave the tangent screw in mesh.

Step 2. Level the Theodolite.

Step 3. When both bubbles indicate the instrument is level, disengage the azimuth scale tangent screw and rotate the azimuth scale exactly 180 degrees. If the bubbles remain centered, the vertical axis adjustment is correct.

Step 4. If the bubbles are not centered, turn the adjusting screw at the back of the levels so the bubbles return half-way to the center. If the bubble is displaced far enough to be against the end of the bubble case, turn the adjusting screw only until the bubble starts to move. Rotate the screw back to zero degrees azimuth, and center the bubble with diagonally opposite leveling screws. Continue this procedure until at 180 degrees azimuth; the bubble is away from the end of the bubble case.

Step 5. Return the azimuth scale to zero degrees and adjust each pair of diagonally opposite leveling screws to center the bubbles.

Step 6. Rotate the azimuth scale to 180 degrees. If the bubble in each level remains centered, the adjustment is satisfactory.

Step 7. If the bubbles again move off center, remove one-half the error by adjusting the bubble level screws. Return the azimuth scale to zero degrees, and re-level the instrument. Continue the above procedure until the bubbles remain centered for all positions of the azimuth scale.

CAUTION

Before making the correction, always re-level the Theodolite and rotate the azimuth scale 180 degrees. To avoid confusion, always level at zero degrees and correct at 180 degrees.

Line of Collimation Adjustment

D-13. The line of collimation is a line through the optical center of the object lens, the prism, and the cross-hairs intersection of the telescope. The line of collimation should make a 90-degree angle in the prism. The purpose of this adjustment is to make the line of sight through the telescope correspond to the line of collimation. If the vertical cross hair does not fall on the target after rotating 180 degrees and the apparent error exceeds 0.2 degree, a correction may be required for precise azimuth readings. However, the necessity for this adjustment is not as great in flight inspection work as the elevation scale adjustment in paragraph D-14. The line of collimation error is

constant throughout, therefore this error is compensated for when the azimuth scale is aligned to a reference bearing. If the line of collimation adjustment is deemed necessary, refer to higher echelon maintenance.

Elevation Scale Fiducial Mark Adjustment

D-14. The purpose of this adjustment is to make the elevation scale indicate zero degrees when the horizontal axis of the Theodolite lies in the horizontal plane. This adjustment should be checked each time the Theodolite is set up to measure vertical angles (for example, in glide slope flight checks). The adjustment should be made if the indicated error, described below, exceeds 0.02 degree. Use the following steps 1 through 11 to measure the error.

Crosshair

Step 1. Set up and level the Theodolite.

Step 2. Set the azimuth scale and the elevation scale at exactly zero degrees, and leave the tangent screws in mesh.

Step 3. Loosen the lower clamp wing screw and rotate the instrument horizontally, while looking through the eyepiece, until you select a target some distance away. (This target must lie on the horizontal crosshair, be well defined in the vertical plane, and permit re-identification.)

Step 4. Tighten the wing screw and adjust the slow-motion screw until both crosshairs lie exactly on the target.

Step 5. Disengage the elevation scale tangent screw and rotate the telescope 180 degrees.

Step 6. Engage the tangent screw and set it exactly to 180 degrees.

Step 7. Disengage the azimuth scale tangent screw and rotate the base plate to 180 degrees.

Step 8. Engage the tangent screw and set it exactly to 180 degrees. If the crosshairs again fall exactly on the target, there is no error.

Step 9. If the horizontal cross-hair does not fall exactly on the target, turn the elevation scale tangent screw until it does.

Step 10. Note the reading of the elevation scale. The deviation from 180 degrees is the apparent error of the fiducial mark and is double the real error.

Step 11. If the vertical crosshair does not fall on the target, and the apparent error exceeds 0.02 degree, refer to higher echelon maintenance.

POSITIONING

D-15. The Theodolite will be positioned according to the criteria for the precision approach radar. Figure D-4 through figure D-9 show how to position and reposition the Theodolite. If an aircraft equipped with the automatic flight inspection system is not used for the commissioning inspection, a Theodolite shall be used to determine glide angles including lower safety limits. For a PAR facility performance evaluation, the Theodolite is placed as close to the runway as possible. However, it must be placed forward of the runway point of intercept (RPI) to minimize or eliminate the elevation difference between the RPI (touchdown) and the

Theodolite location; this difference includes the height of the Theodolite eyepiece. The touchdown reflector is usually abeam the RPI, but not always. Aircraft operations will dictate how close to the runway the Theodolite can be located.

Note: The elevation and azimuth scales are graduated in whole degrees, whereas the elevation and azimuth tangent screws are accurately in degrees and tenths of a degree.

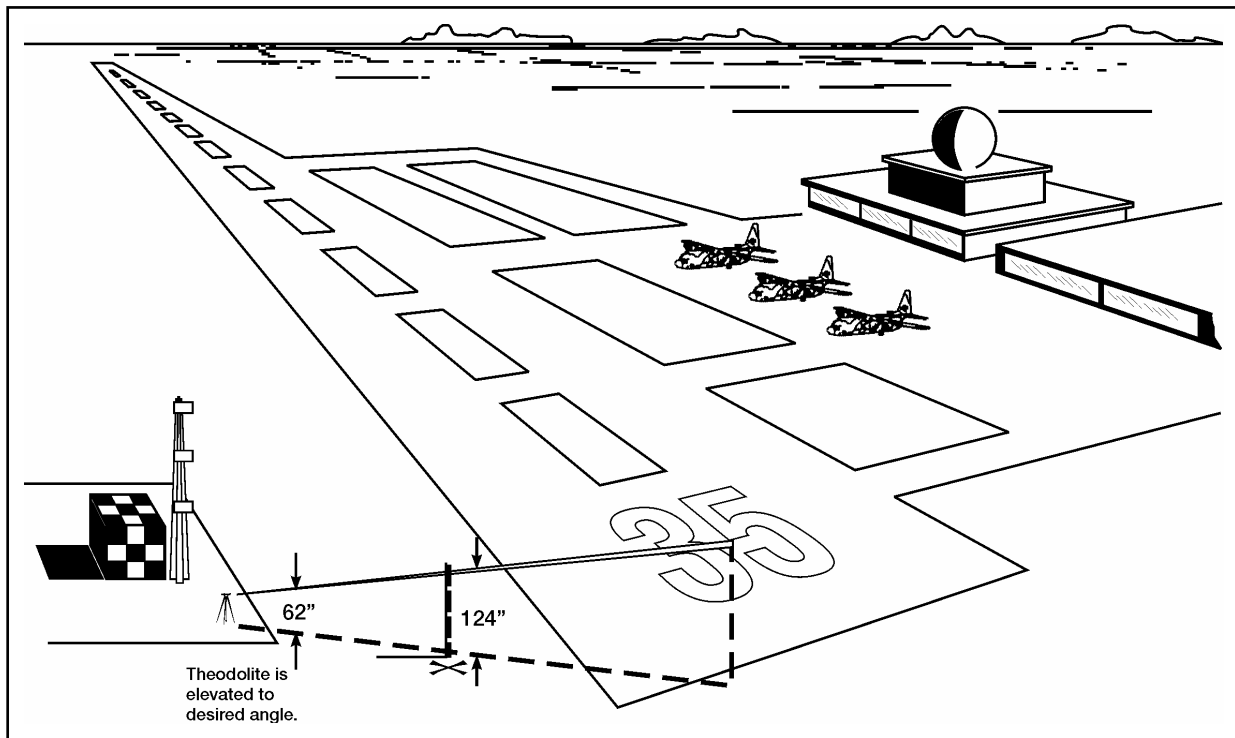

Figure D-4. Theodolite Positioned

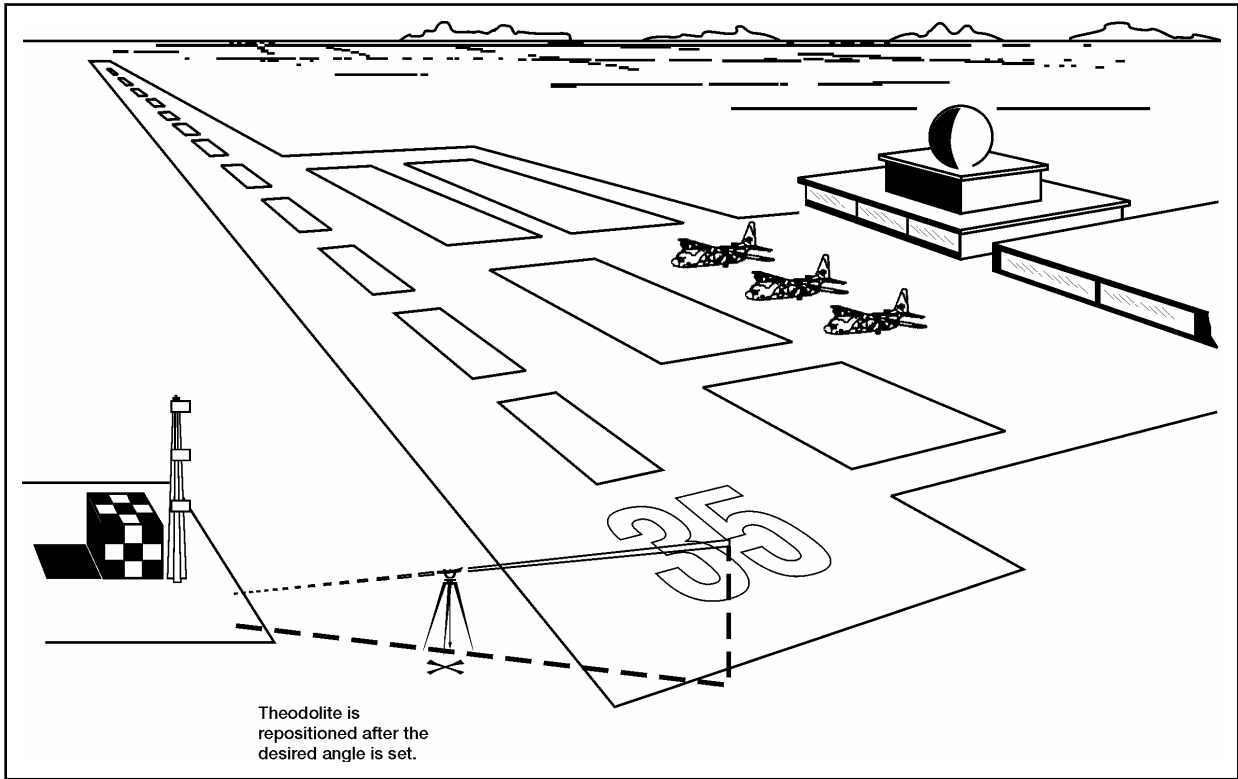

Figure D-5. Desired Angle Set and Theodolite Repositioned

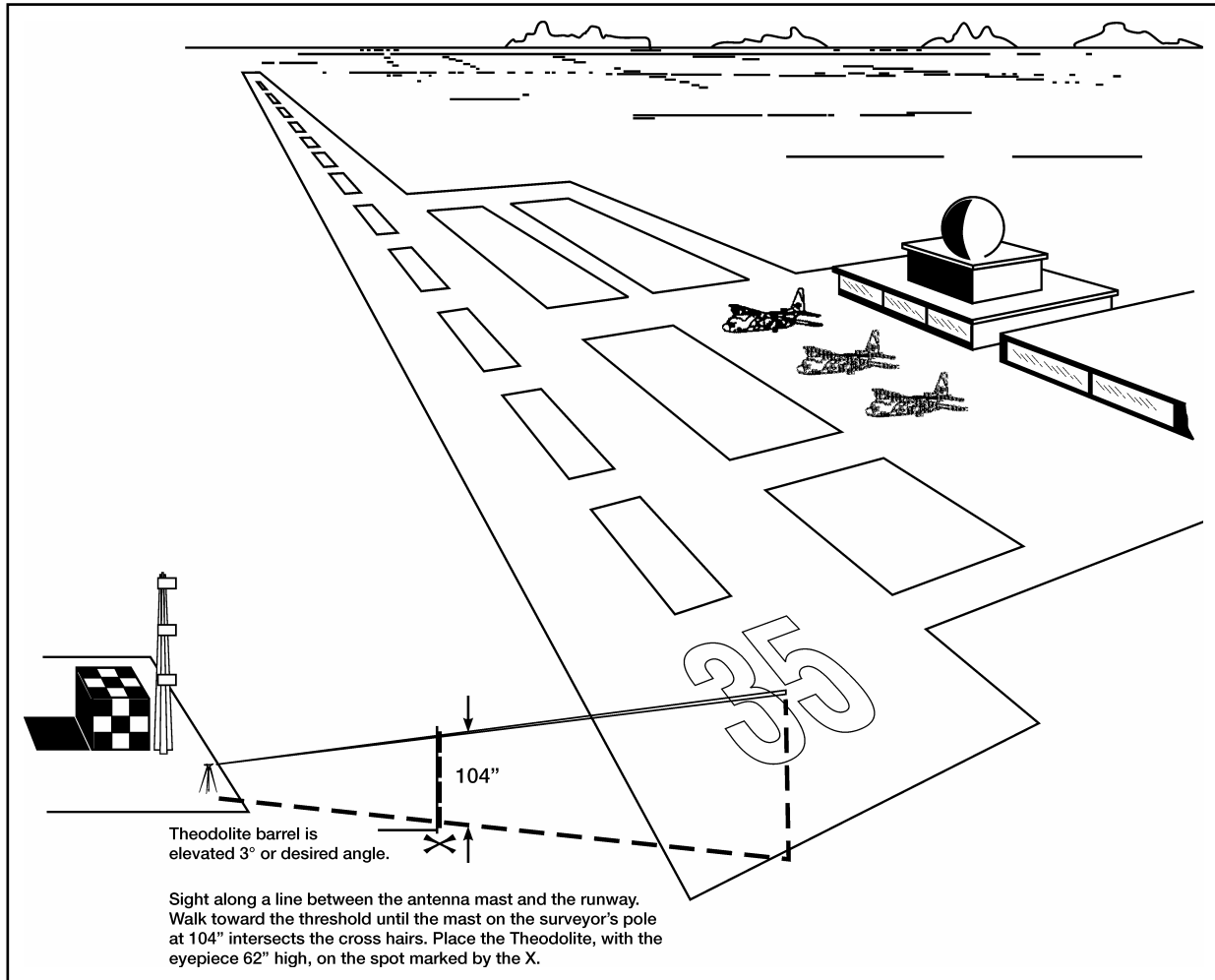

Figure D-6. Theodolite Barrel Elevated

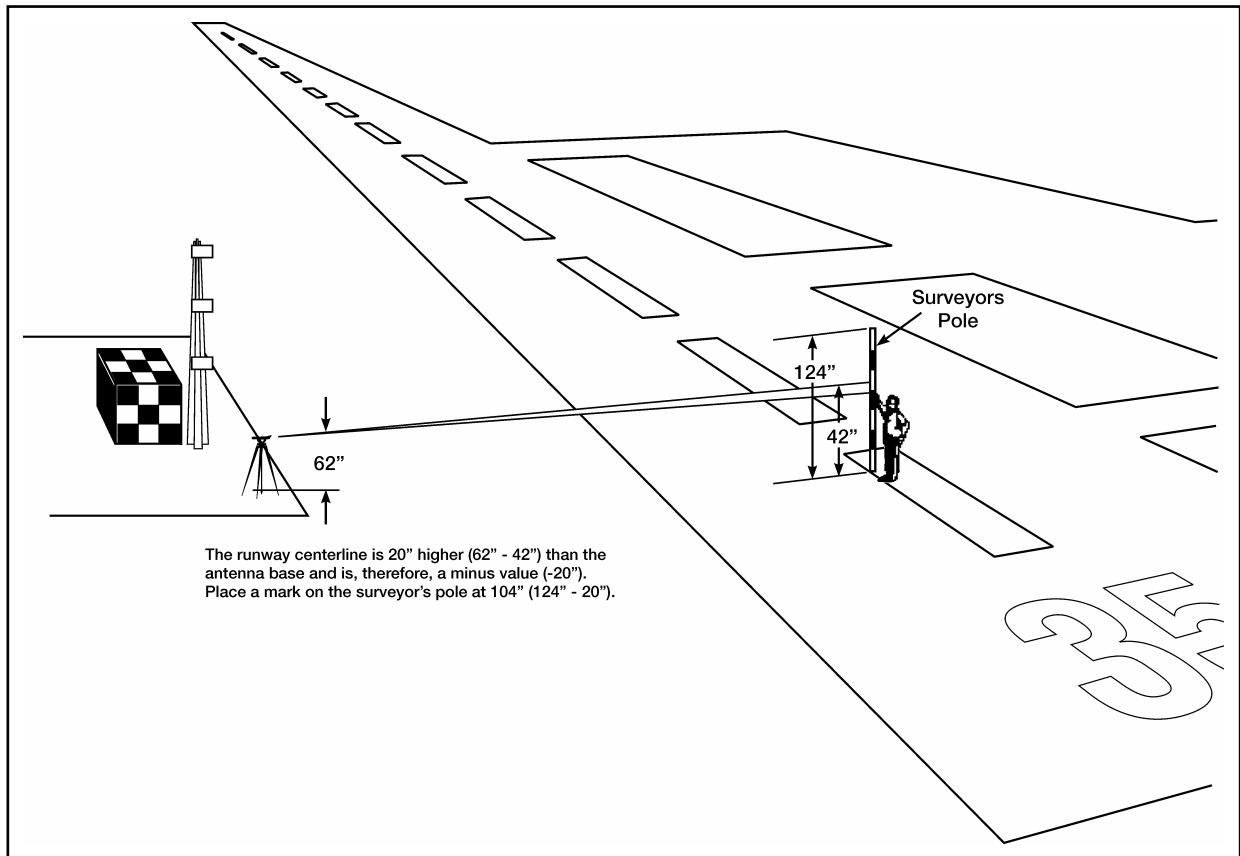

Figure D-7. Adjustment for Height Differences

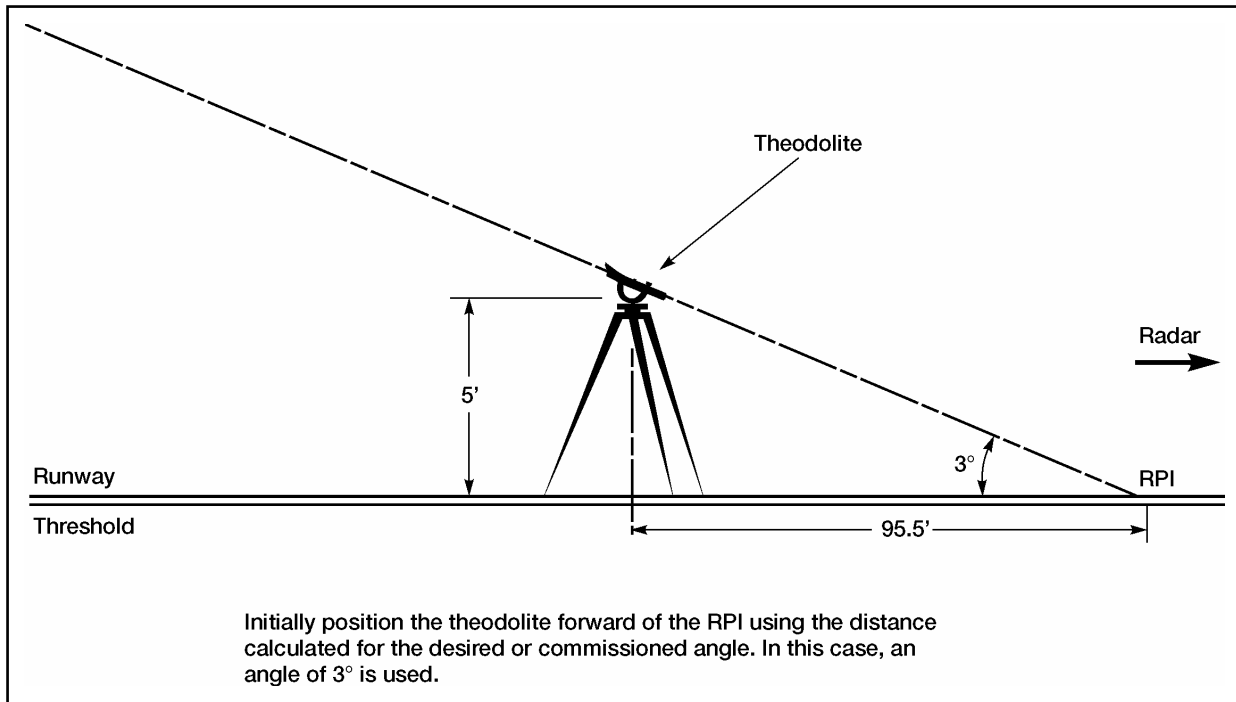

Figure D-8. Theodolite Positioned for Zero Elevation Difference

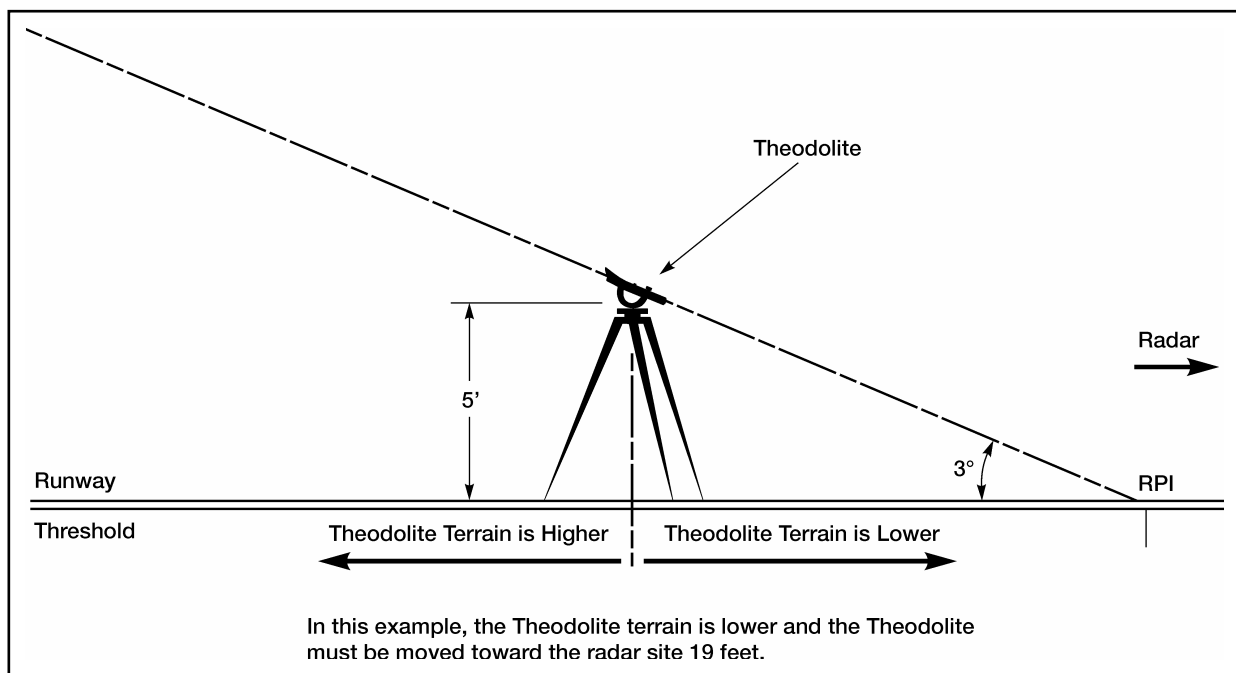

Figure D-9. Theodolite Positioned for Known Elevation Difference

ORIENTATION

D-16. The Theodolite is oriented on the actual glide slope angle (for example, 2.5 degrees) on the vertical scale when set up on the observation point and viewing the approach end of the runway. The following steps will orient the Theodolite properly.

Step 1. With a lensatic compass, select a prominent object; record its bearing from the observation point.

Step 2. Place the Theodolite at the observation point.

Step 3. Level the Theodolite.

Step 4. Set the azimuth scale and azimuth scale tangent screw to read the exact azimuth of the established reference point.

Step 5. Loosen the lower clamp and sight the reference point as close to the vertical crosshair as possible.

Step 6. Retighten the lower clamp, then adjust the slow-motion screw until the vertical crosshair is exactly on the reference point. Make the final adjustment by turning the slow-motion screw clockwise.

Note: Because of the prism arrangement in some Theodolite telescopes, objects viewed through the proper plane may be presented upside down. When the aircraft appears in the bottom half of the scope, it is high. When it appears in the top half, it is low.

CHECK COMMISSIONING FACTORS

D-17. Communications with GCA is essential during a PAR flight inspection. Only *on glide path* calls shall be recorded. Calls inside of decision height shall not be recorded. Radar shall be capable of detecting an aircraft a minimum of 7.5 nautical miles from touchdown and within the azimuth and elevation sector portrayed on the radar scope.

D-18. The flight check is a team effort; therefore, good communications is vital. Aircrew members will continuously advise the Theodolite operator of their intentions. The Theodolite operator should ask questions if there is doubt, and request assistance if problems arise.

Note: To correctly evaluate the equipment, it is important to record at least 15 to 20 *on glide path* calls.

D-19. Three approaches for each runway and one lower safe check are required for commissioning. The lower safe limit is normally 0.5 degree less than the glide path angle; however, obstacle clearance is all that is required.

D-20. To evaluate bends on the approach, range shall be given at least once per mile.

D-21. The Theodolite is placed as close to the runway as possible and forward of the runway point of intercept. The locations of the marked reference

points are calculated using the formulas shown below. Figure D-10 shows how to determine zero elevation differences.

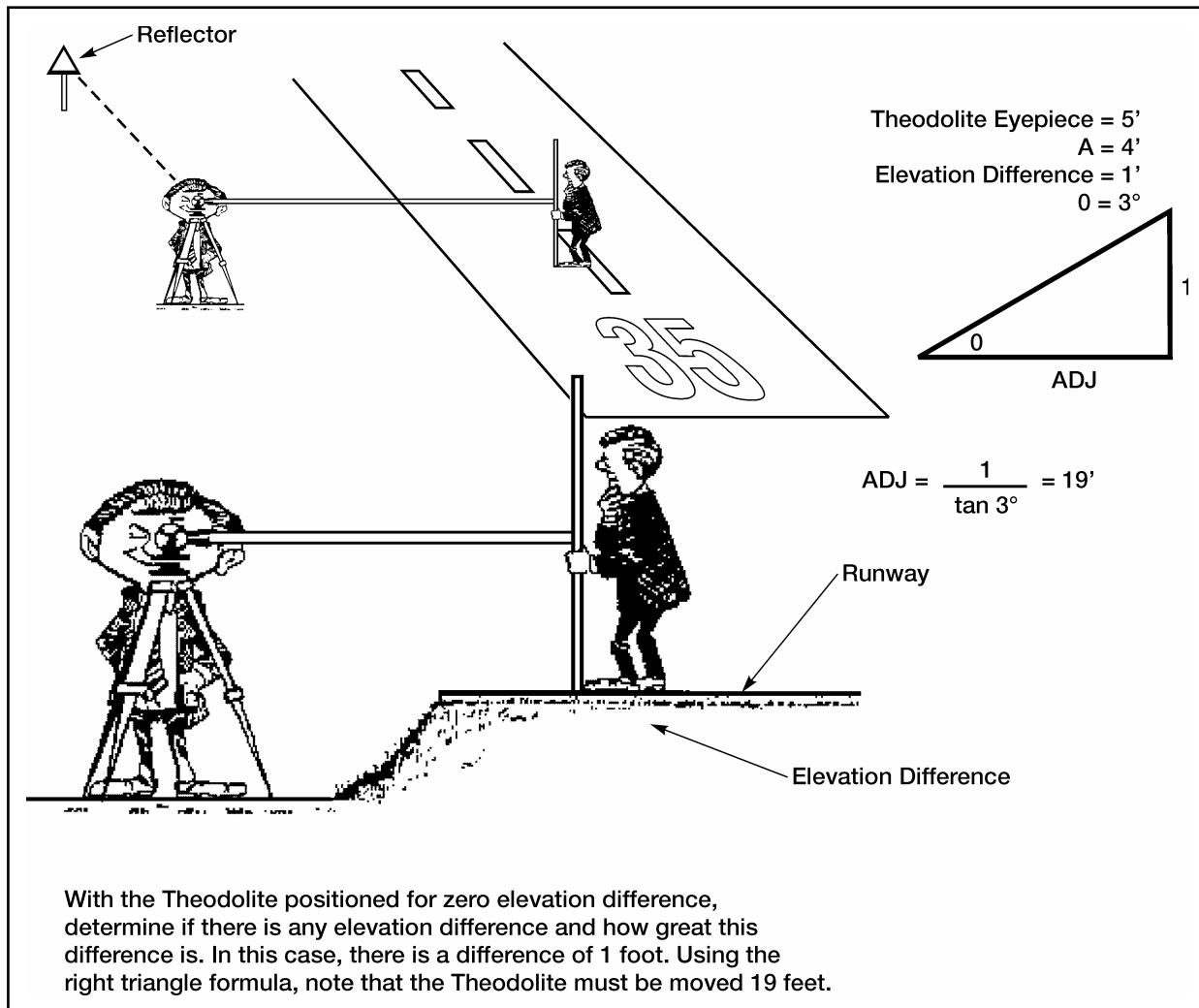

Figure D-10. Zero Elevation Difference Calculated

Formulas:

Opposite = Adjacent X Tangent; or $O = A \times T$.

Adjacent = Opposite/Tangent; or $A = O/T$.

Tangent = Opposite/Adjacent; or $T = O/A$.

Example. A 5-foot/3-degree tangent (.0524078) = 95.4 feet. Therefore, the Theodolite would be placed 95.4 feet forward of RPI.

Problems and Solutions:

With a 1,200-foot ceiling and a 3-degree angle, what is the distance? The solution is $1,200/3 \text{ degrees } (.0524078) = 22897.365/6076.1 = 3.76$ nautical miles. This is not acceptable.

With a 2,000-foot ceiling and a 3-degree angle, what is the distance? The solution is $2,000/3 \text{ degrees } (.0524078) = 38162.275/6076.1 = 6.28$ nautical miles. This is acceptable.

PREVENTIVE MAINTENANCE

D-22. Theodolite operators must keep the instrument clean and protect it from damage through mishandling or neglect. Listed below are some of the measures operators should take to keep the Theodolite in good condition.

ROUTINE CARE OF THE INSTRUMENT

- Protect it from dust and foreign matter by covering it with the canvas hood while it is left standing unused or by packing it in its carrying case to transport it.
- Inspect it for loose or broken parts after it has been used.
- Take care not to twist off the brass screws when tightening them.
- Occasionally wipe off the instrument (except for the telescope lens) with a soft, clean cloth.
- Clean the telescope lens with a clean, soft-haired brush, then wipe it clean with special lens tissue.
- If lens tissue is not available, use either a soft facial tissue or a linen handkerchief that has been washed several times. Be careful not to wipe the lens because the lens surface is easily ruined by scratches.
- If it is necessary to clean the inside surface of the lens, unscrew the object lens barrel, but do not remove the lens from the barrel.
- If it is necessary to clean the lens, unscrew the eyepiece but be careful not to touch the fragile cross hairs that are exposed.
- If the silvered surfaces of the tangent screw drum scales and the elevation scale become tarnished from contact with the operator's hands, remove the oxidation by rubbing the surfaces with bone black or by applying a few drops of clock oil. Leave the oil on the surfaces overnight, then wipe the surfaces clean with a soft cloth. Leave a very thin film of oil on the surfaces to protect them. (The azimuth scale is covered and does not require routine cleaning.)
- Replacement in Carrying Case.
- Remove the sunshade from the telescope, and place it on the baseboard with the long side away from the center of the baseboard. Place the dust cap over the object lens of the telescope. Fold the long sights flat down.
- Disengage the elevation tangent screw, and swing the telescope upside down so the sights are on the bottom of the tube. Do this carefully so that long rear sight does not strike the transverse level. Point the object lens up at about a 30-degree angle. Leave the tangent screw disengaged.
- Disengage the azimuth tangent screw. Unscrew and remove the Theodolite from the tripod head, keeping one hand on the instrument at all times. Cradle the instrument against the body with the forearm while replacing the baseboard on the Theodolite by turning it clockwise.

- Rotate the Theodolite until the rear end of the baseboard slides into the case and the wood blocks face outward. Reposition the telescope slightly, as necessary, to permit the baseboard to slide all the way in and the door on the carrying case to shut.
- Replace the screw cap protecting the treads of the tripod heads.

Appendix E

Air Traffic Control Tape Transcriptions

This appendix is an example format for transcribing air traffic control tapes. Memorandum format contained in AR 25-50 is the Army standard.

PURPOSE

E-1. The following format will standardize transcribing tapes for accidents/incidents.

CONTENTS

- Subject.
- Recording facility.
- List of transmitting facilities.
- Facility, land line, or position being recorded.
- Date of, and time covered by, transcript.
- Certification.

FORMAT

E-2. The following figure provides the required memorandum format for tape transcriptions.

DEPARTMENT OF THE ARMY ORGANIZATION NAME/TITLE CITY, STATE, AND ZIP CODE	
OFFICE SYMBOL (MARKS NUMBER)	DATE
MEMORANDUM FOR	
SUBJECT: Transcript of Accident/Incident of (Aircraft call sign) on (Date)	
1. The recording facility was (facility name).	
2. The following is a list of facilities/operating position(s)/aircraft (and their abbreviations) that made transmissions during the period 5 minutes prior to 5 minutes after the recorded accident/incident.	
OFFICE SYMBOL	
SUBJECT: Transcript of Accident/Incident of (Aircraft call sign) on (Date)	
<u>TRANSMITTER</u>	<u>ABBREVIATION</u>
R12345	R345
Coastal	C-AIC
3. The time period covered and date of this transcript is from (5 minutes prior to accident/incident) to (5 minutes after accident/incident) on (date).	
4. As custodian of the original recording, I certify this to be a true and exact <u>TRANSCRIPT</u> thereof.	
FRED E. JOHNSONE SFC, USA Tower Chief	

Figure E-1. Memorandum Format for Official Tape Transcriptions

Appendix F

Risk Management

Risk management is not an add-on feature to the decisionmaking process, but rather a fully integrated element of planning and executing operations... Risk management helps us preserve combat power and retain the flexibility for bold and decisive action. Proper risk management is a combat multiplier that we can ill afford to squander.

General Dennis J. Reimer
Chief of Staff, Army
27 July 1996

Risk decisions are the commander's business. Such decisions are normally based on the next higher commander's guidance on how much risk he is willing to accept and delegate for the mission. Risk decisions should be made at the lowest possible level, except in extreme circumstances. FM 100-14 and this appendix provides guidance on risk management; use this appendix as a tool when assessing ATS missions.

RISK MANAGEMENT PROCESS

F-1. Risk management is the process of identifying, assessing, and controlling risks arising from operational factors, and making decisions that balance risk costs with mission benefits. Hazards and the resulting risks may vary as circumstances change and experiences are gained. Leaders and individual soldiers become the assessors for ever-changing hazards (such as those associated with environment—weather, visibility, contaminated air, water, and soil—equipment readiness, individual and unit experience, and fatigue). The risk management process allows individuals to make informed, conscious decisions and accept risks at acceptable levels.

F-2. During the exercise planning stage, a risk assessment must be conducted to accomplish risk management. This systematic process helps leaders make informed decisions. The five major areas for risk assessment are fiscal, threat, tactical doctrine, physical security, and safety. Leaders must complete the following five steps for risk management. Tactical units shall conduct risk assessment before each mission. Each tactical facility shall develop its own risk assessment. See table F-1 for an example of a risk assessment worksheet.

Step 1. Identify Hazards

F-3. Make an operations analysis. This is simply a description, normally in time sequence, of the events that are expected to occur during the operation.

F-4. Make a preliminary hazard analysis. This is a list of the various hazards that could occur and result in accidents. It is developed using experience, the data base, and scenario thinking or similar techniques.

F-5. If necessary, use a more in-depth hazard analysis. This analysis is normally used when time permits or when certain risks require more careful consideration to be fully understood.

Step 2. Assess Hazards

F-6. Assess the various hazards to determine their relative probability and severity and their potential impact on the mission.

Step 3. Make Decisions and Develop Controls

F-7. Develop risk control options, starting with the most serious risks.

F-8. Complete a training realism assessment to assure the suitability of risk controls.

F-9. Make risk decisions. Select risk controls that will reduce the risk to a practical minimum consistent with the mission objectives.

Step 4. Implement Controls

F-10. Implement the risk control procedures. Implementation is best accomplished by integrating the procedures as standards in unit SOPs, orders, and training operations.

Step 5. Supervise

F-11. Maintain the effectiveness of risk controls by ensuring that risk control standards are as effective as expected and kept at high levels.

Table F-1. Sample Installation Risk Assessment			
1. Facility Personnel Experience	All CTO Rated	All Rated Mixed (CTO/ATCS)	One Or More Not PQ
Inexperience– (<6 Mos)	3	4	5
Experience– (6 – 12 Mos)	2	3	4
Experience– (>12 Mos)	1	2	3
2. Airport Structure (Select one each line)	< Or = 1	2 – 3	3 Or More
a. Number of Adjacent Facilities Within 15 nautical miles	1	2	3
b. Number of Primary Landing Surfaces	1	2	3
c. Number of NAVAIDS	1	2	3
d. Number of Coordinating Facilities	1	2	3
3. Traffic Density	Day	Night	Night vision goggles (NVG)
20 + A/C per hour	3	4	5
5 – 19 A/C per hour	2	3	4
LESS THAN 5 per hour	1	2	3
4. Weather	Wet Bulb Globe Temperature (WBGT) Category I	(WBGT) Category II/III	(WBGT) Category IV/V
Night IFR	3	4	5

Table F-1. Sample Installation Risk Assessment			
Day IFR	2	3	4
Day/Night VFR	1	2	3
5. Fighter Mgmt Rest	On Shift 8 Hours	On Shift 9 Hours	On Shift 10 Hours
8 Hours	—	4	5
8 – 12 Hours	2	3	4
12 – 24 Hours	1	2	3
Note: Shift member with the least amount of rest will be used for calculation			
6. Cumulative Fighter Mgmt Hrs Worked In — Days	0 – 2 Weeks Over 40 Hrs	3 – 6 Weeks Over 40 Hrs	More Than 6 Weeks Over 40 Hrs
50 +	3–4	5	
40 – 50	2	3	4
LESS THAN 40	1	2	3
<p>Notes: As a minimum paragraph 1, 5, and 6 shall be used in all installation ATC risk assessments.</p> <p>New risk assessment should be completed semiannually or when there is a change in facility operating hours or airport structure. Any significant change in personnel should be considered as a cause for a new risk assessment.</p> <p>Instructions: Under the appropriate column circle only one value for each numbered block. For block 2, circle one value for each line. Total all circled values and compare to ATS/ATC risk matrix.</p>			

Table F-2. Sample Tactical Risk Assessment			
1. Team Experience	All CTO Rated	All Rated Mixed (CTO/ATCS)	One Or More Not PQ
Inexperience– (<3 Months)	3	4	5
Experience– (3 – 6 Months)	2	3	4
Experience– (>6 Months)	1	2	3
2. Mission Planning Time Allotted To Plan	8 Hours	4 – 8 Hours	Less 4 Hours
Complex	3	4	5
Routine–New Mission	2	3	4
Routine–Same Mission	1	2	3
3. Traffic Density	Day	Night	Nvg
20 + A/C per hour	3	4	5
5 – 19 A/C per hour	2	3	4
Less Than 5 per hour	1	2	3

Table F-2. Sample Tactical Risk Assessment

Table F-2. Sample Tactical Risk Assessment			
4. WEATHER	(WBGT) Category I	(WBGT) Category II/III	(WBGT) Category IV/V
Night IFR	3	4	5
Day IFR	2	3	4
Day/Night VFR	1	2	3
5. Environment Operating Environment	Garrison/ EXCL Condition	Tactical AVG Condition	Tactical POOR Condition
TAC/Unsecured	3	4	5
TAC/Secured	2	3	4
Garrison	1	2	3
6. Fighter Mgmt Rest	On Shift 8 Hours	On Shift 10 Hours	On Shift 12 Hours
8 Hours	—	4	5
8 – 12 Hours	2–3	4	
12 – 24 Hours	1	2	3
Note: Team member with the least amount of rest will be used for calculation			
7. Cumulative Fighter Mgmt Hrs Worked In — Days	0 – 2 Weeks Over 40 Hrs	3 – 6 Weeks Over 40 Hrs	More Than 6 Weeks Over 40 Hrs
50 +	3	–4	5
40 – 50	2	3	4
Less Than 40	1	2	3
Notes: As a minimum paragraph 1, 6, and 7 shall be used in all tactical ATS risk assessments.			
Instructions: Under the appropriate column circle only one value for each numbered block. Total all circled values and compare to ATS/ATC risk matrix.			

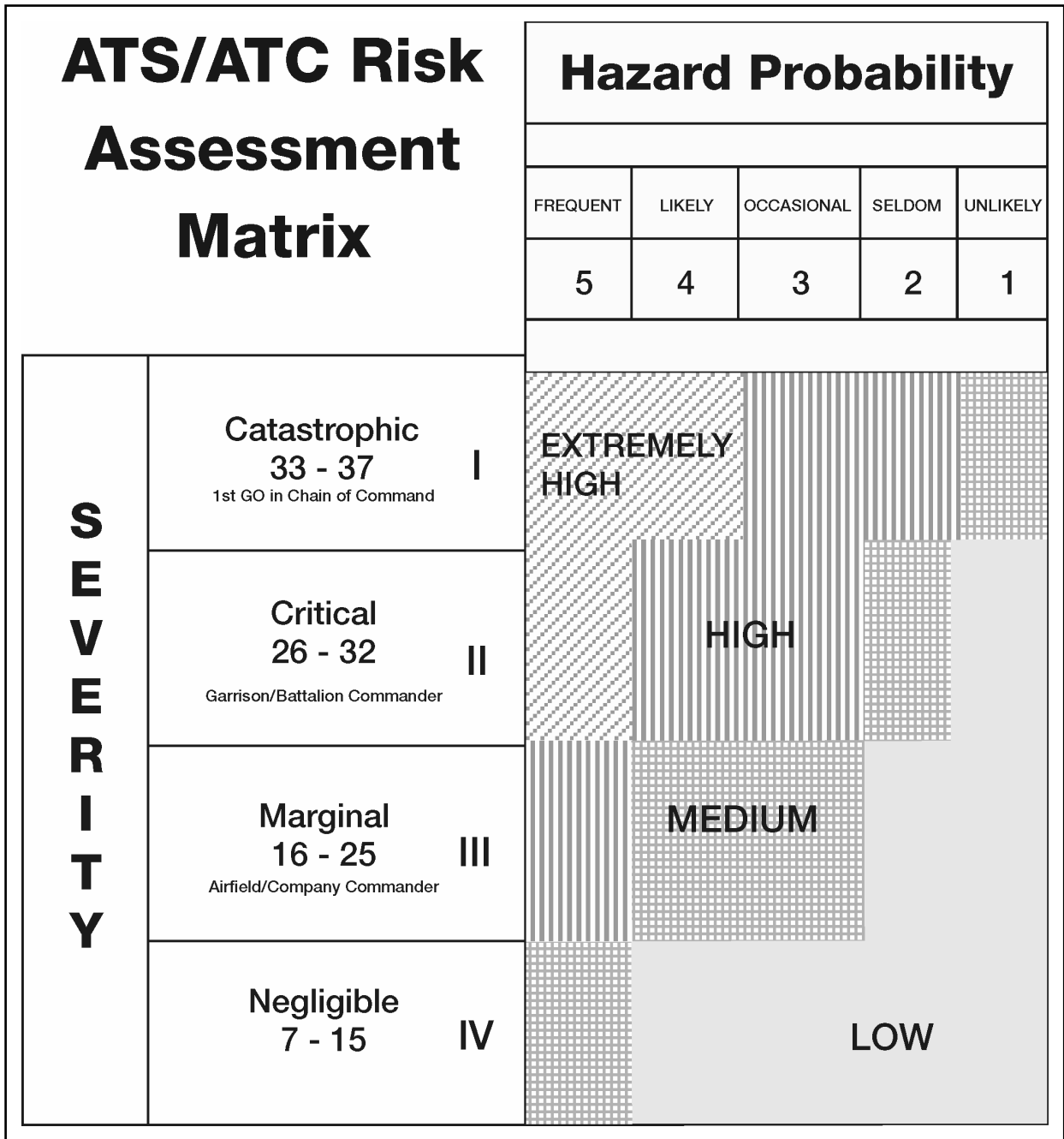

Figure F-1. Sample Risk Matrix

Appendix G

Tactical Operations

This appendix contains criteria and guidance on tactical deployment of ATS NAVAIDS. Commanders should use this appendix as a tool for assessing ATS mission requirements. Additional information may be found in FAAO 8260.3, FAAO 8260.15D, and FAAO 8260.36A.

TERMINAL INSTRUMENT PROCEDURES

G-1. Terminal instrument procedures (TERPS) is the process of developing approach procedures based on location, obstacles, airspace, air traffic flow, procedures desired, and aircraft performance in accordance with FAAO 8200.1, FAAO 8260.15D, FAAO 8260.3B, and this manual.

G-2. Under National Agreement (NAT) 127, the FAA provides worldwide terminal instrument procedures service for the U.S. Army. This service shall include original procedure development and amendments as necessary (to include procedures for contingency/exercise operations), facility and procedure flight inspection service, site evaluation of proposed navigational aids, procedure processing, and publication. Request for procedure development shall be forwarded to the FAA through the DARR, USAASD-E Commander, or Eighth Army ATC Office.

REQUIRED INFORMATION FOR PROCEDURE DEVELOPMENT

G-3. In accordance with NAT 127, the following information is required for procedure development (see figures G-1 through G-3, pages G-3, G-4, and G-7).

- Type procedure requested.
- Type radar system in use.
- Two copies of FAA Form 7210-9 (*En Route Minimum IFT/Minimum Vectoring Altitude Obstruction Document*).
- Two copies of the sectionals used for the MVA chart (MVAC).
- Requested glideslope (GS).
- Requested threshold crossing height (TCH).
- Runway point of intercept (RPI) distance.
- Ground plane intercept (GPI) distance.
- Requested decision height.
- Latitude/longitude/elevation of—
 - Runway threshold (RWY THLD).
 - Runway departure end.
 - Touchdown (TD)/runway point of intercept (RPI).
 - Radar receiver/transmitter (R/T) group.
 - Ground plane intercept (GPI).

- NDB location.
- NDB approach information (identifier, frequency, holding patterns, altitudes, fixes, include any restrictions, such as remain within five nautical miles).
- Missed approach procedure (straight or turning with direction).
- Airport information.
- Name (identifier), elevation.
- NAVAIDS (include type, location, procedure, glideslope, if applicable).
- Runway number, length, width, lighting (include approach lights), markings, composition.
- Displaced threshold (latitude/longitude).
- Any photographs of airport (surface, air, or satellite), maps (scale 1:24,000 through 1:500,000), airport layout plans (ALP) or civil engineering master tabs, if available.

IDENTIFYING OBSTACLES

G-4. Obstacles (manmade or natural) within 25 nautical miles (at a minimum) of a tactical NAVAID shall be identified and annotated on FAA Form 7210-9 (see figure G-1). This example is completed using non-mountainous terrain required obstacle clearance (ROC) of 1000 feet in lieu of mountainous terrain (ROC 2000). The example also shows how the horizon may be broken down into four equal areas of ninety degrees each and ranges in increments of 5 to 10 miles. This makes it easier to scan for obstacles. When obstacles are identified, they will be used to determine the procedure altitudes for the NDB, the minimum vectoring altitude (MVA), minimum safe altitude (MSA), lowest usable glidepath, and any required adjustments to the missed approach procedure. U.S. Army ATS facilities shall forward two copies of new or revised MVAC and FAA Form 7210-9 to the appropriate DARR for review. For U.S. Army installations outside U.S. territory and not under an FAA regional office, MVAC shall be forwarded to HQ USAASA or USAASD-E respective of the area of responsibility. Chapter 3 contains more information on the development of minimum vectoring altitude charts (MVAC).

MINIMUM VECTORING ALTITUDE OBSTRUCTION DOCUMENTATION							
<i>Instructions for Altitude Selection Refer to Handbook 8260.19, Chapter 3, Section 9, Radar Vectoring Charts.</i>							
AREA/ ZONE	CONTROLLING OBSTRUCTION	LOCATION AZ / DIST	ELEVATION MSL	ROC	ALTITUDE ADJ	MINIMUM ALTITUDE	REMARKS
1	Spot Elevation	002 / 9.7NM	1785	1000	2785	2800	Zone 1=000-090 Airport to 10NM
1	Antenna Group	023 / 4NM	983	1000	1983	2000	
1a	Antenna	030 / 12.5NM	1608	1000	2608	2600	Zone 1 10 to 15 NM
1a	Antenna Group	033 / 11.4NM	1928	1000	2928	2900	
1b	Antenna Group	018 / 23.1NM	1947	1000	2947	2900	Zone 1 15 to 25 NM
1b	Antenna	040 / 24.5NM	2001	1000	3001	3000	
1b	Antenna Group	086 / 20.1NM	1046	1000	2046	2000	
2	Antenna Group	120 / 9.9NM	860	1000	1860	1900	Zone 2=090-180 Airport to 10NM
2	Antenna Group	142 / 6.7NM	812	1000	1812	1800	
2a	Antenna	117 / 11.4NM	775	1000	1775	1800	Zone 2 10 to 15 NM
2a	Antenna Group	165 / 12.7NM	1943	1000	2943	2900	
2b	Antenna	093 / 22.9NM	869	1000	1869	1900	Zone 2 15 to 25 NM
2b	Antenna	118 / 20.2NM	1426	1000	2426	2400	
3	Antenna Group	206 / 6.5NM	824	1000	1824	1800	Zone 3=180-270 Airport to 10NM
3	Spot Elevation	266 / 3.3NM	1289	1000	2289	2300	
3a	Antenna	185 / 12.5NM	784	1000	1784	1800	Zone 3 10 to 15 NM
3a	Antenna Group	258 / 14.9NM	2037	1000	3037	3000	
3b	Antenna	181 / 23.4NM	888	1000	1888	1900	Zone 3 15 to 25 NM
3b	Antenna	265 / 21.8NM	814	1000	1814	1800	
4	Lookout Tower	277 / 9.1NM	1690	1000	2690	**2800**	Zone 4= 270-360 Airport to 10 NM
4a	Lookout Tower	314 / 9.7NM	1661	1000	2661	**2800**	Zone 4 10 to 15 NM
4b	Antenna	283 / 15.5NM	1080	1000	2080	2100	Zone 4 15 to 25 NM
NOTE Obstacle height is from base of Lookout Towers. During evaluation, 100 feet was added to original obstacle height.							
APPROVED							
Air Traffic manager (signature)			Date	TTFO Manager (signature)		Date	

FAA FORM 7210-9

Figure G-1. Sample Obstruction Documentation

RADAR REFLECTOR DIAGRAM

G-5. These diagrams provide accurate information about the radars installation and its location in relation to the runway/landing area. This diagram may also assist tower personnel by alerting them to hazardous/restricted areas in relation to the radar facility. When flight

inspection (FI) of the radar is conducted by ATSCOM, the FI team will use a theodolite provided by the unit, their own theodolite, or the automated flight inspection system (AFIS). The sample radar reflector diagram (figure G-2) shows all the information that the AFIS requires to complete a commissioning flight inspection of IFR/VFR radar facilities. This information shall be sent to ATSCOM along with the request for flight inspection.

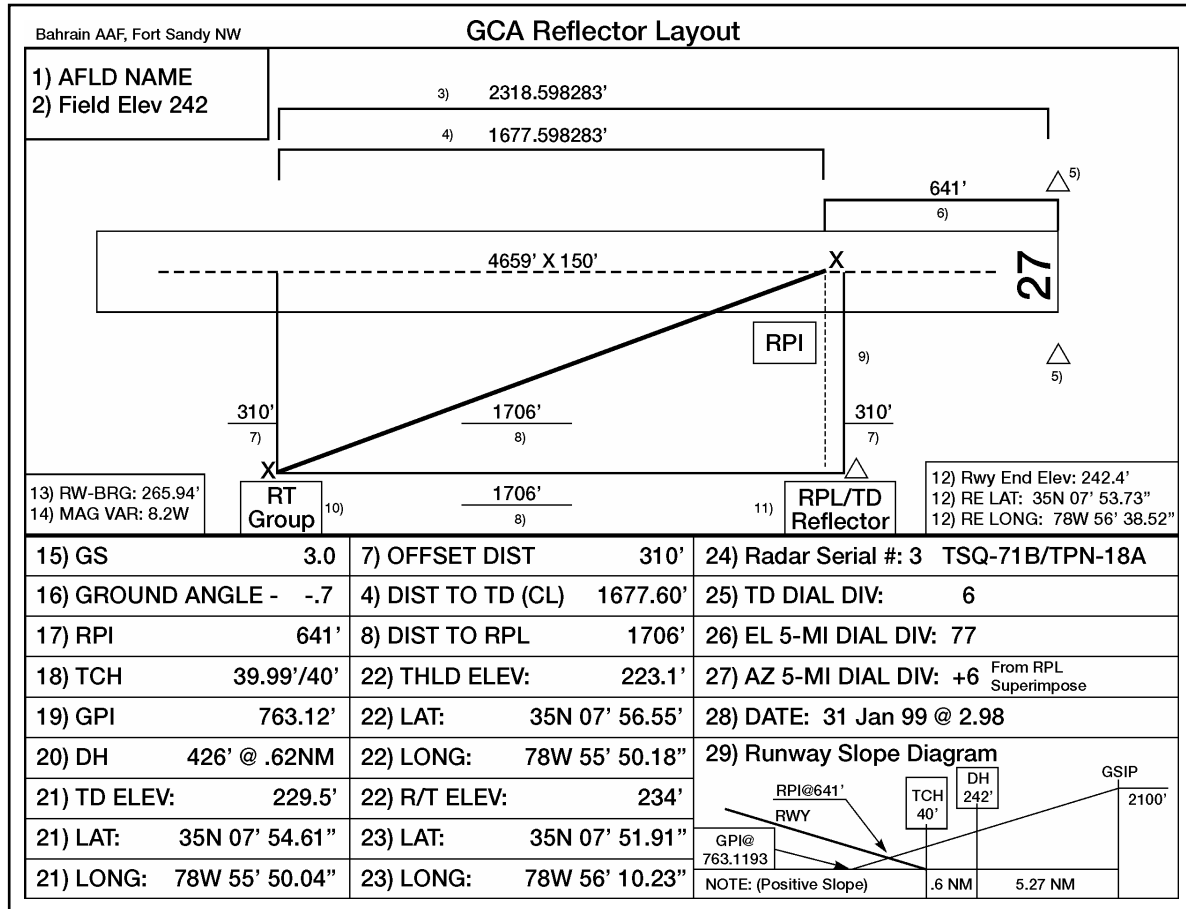

Figure G-2. Radar Reflector Diagram (Left of Runway)

G-6. The radar reflector diagram is completed as follows:

Items 1 and 2. Self explanatory

Item 3. Insert distance from abeam receiver/transmitter (R/T) group, to RWY THLD on runway centerline.

Item 4. Insert distance from abeam R/T group, to TD/RPI on RWY centerline.

Item 5. Determine which reflector method will be used. (Centerline reflector shall be a minimum of 200 feet from THLD toward approach path of aircraft in accordance with FAAO 8260.3 (TERPS). Bracket reflectors shall be a minimum of 75 feet off RWY centerline. If brackets are used to mark TD/RPI, they are set up 90 degrees of RWY centerline abeam TD/RPI. Also see Item 9).

Item 6. Insert distance from TD/RPI to RWY THLD.

Item 7. Insert offset distance from R/T group to RWY centerline.

Item 8. Insert distance from R/T group to TD/RPI on angle. (Item 4 squared + Item 7 squared = ? (push inverse or shift or 2nd function key square) = R/T to TD/RPI on angle.

Example:

Item 4 = 100 feet offset squared = 10,000

Item 7 = 1,000 feet squared = 1,000,000

10,000 + 1,000,000 = 1,010,000

1,010,000 INV square = 1,004.987562 feet

Item 8 = 1,004.99 feet

Item 9. Insert distance from runway parallel line (RPL) to TD/RPI on angle. (When RPL is used to mark TD/RPI, it will be farther away from R/T than distance R/T to TD/RPI on centerline). Item 8 above shows that while TD/RPI is 1,000 feet from the R/T on centerline, the actual distance from R/T to TD/RPI on the direct line is 1,004.99 feet. You will have to measure 4.99 feet from TD/RPI toward THLD, then place the RPL reflector 90 degrees off RWY centerline to ensure touchdown rangemark is properly aligned.

Item 10. Location of R/T group.

Item 11. Location of RPL reflector (may be used to mark TD/RPI). (See Item 9.)

Item 12. Insert runway end elevation (departure end of instrument runway), latitude/longitude.

Item 13. Insert runway bearing (for example RWY 27 can be 265 degrees to 274.99 degrees).

Item 14. Insert magnetic variation for the location.

Item 15. Insert glideslope/glidepath angle.

Item 16. Insert ground angle (GA) between R/T and TD/RPI.

Item 17. Insert distance from THLD to RPI.

Item 18. Insert threshold crossing height (TCH) (shall be between 32 feet and 60 feet to avoid requiring a waiver).

Item 19. Insert distance from THLD to ground plane intercept (GPI).

Item 20. Insert decision height (DH) altitude and location (for example .7 nautical miles).

Item 21. Insert airfield elevation at TD with latitude/longitude.

Item 22. Insert airfield elevation at THLD with latitude/longitude.

Item 23. Insert airfield elevation at center of R/T group with latitude/longitude.

Item 24. Insert radar R/T group serial number with type (for example Serial #3, TPN-18A).

Item 25. Insert TD dial division (DD) (for example ground angle (GA) x 20 + 20 = TD DD).

Item 26. Insert elevation 5 mile DD (formula found in equipment technical manual (TM) or use formula as follows for TPN-18/18A).

STEP 1. 30380.5 x tangent (TAN) GS = altitude angle alignment (AAA).

STEP 2. Distance R/T to TD/RPI on angle + 30380.5 = ?

STEP 3. Answer Step 1 / Answer Step 2 = ?

STEP 4. Answer from Step 3 (INV TAN) = EAA.

STEP 5. EAA x 20 + 20 = Elevation 5 mile DD.

Item 27. Insert azimuth 5 mile DD (Formula found in TM or use formula as follows for TPN-18/18A).

STEP 1. Distance R/T to TD/RPI on angle + 30380.5 = ?

STEP 2. Offset distance R/T to centerline / answer of Step 1 = ?

STEP 3. Answer from Step 2 (INV TAN) = ?

STEP 4. Answer of Step 3 (? x 10) = amount to add or subtract from RPL DD. (Left of RWY=Add, Right of RWY=Subtract)

Item 28. Insert date of FI and actual GS angle.

Item 29. Draw runway slope diagram.

FLIGHT INSPECTION

G-7. The FAA and ATSCOM are the only agencies that can *certify* NAVAIDS prior to their use. In accordance with FM 1-120, while deployed in a combat or contingency zone, the ATS unit normally provides limited flight inspection of deployed air navigational facilities, using organic expertise and aviation assets. The ATS commander will be responsible for advising the supported aviation units of the risks involved in using these air navigational facilities when a certified flight inspection has not been performed. This is especially true when instrument meteorological conditions (IMC) may exist. This authority is not meant to supersede the requirement for completing a certified flight inspection, but to allow commanders the flexibility of limited usage of deployed air navigational facilities until such time as a certified flight inspection may be completed. See figure G-3 for further certification requirements/guidance.

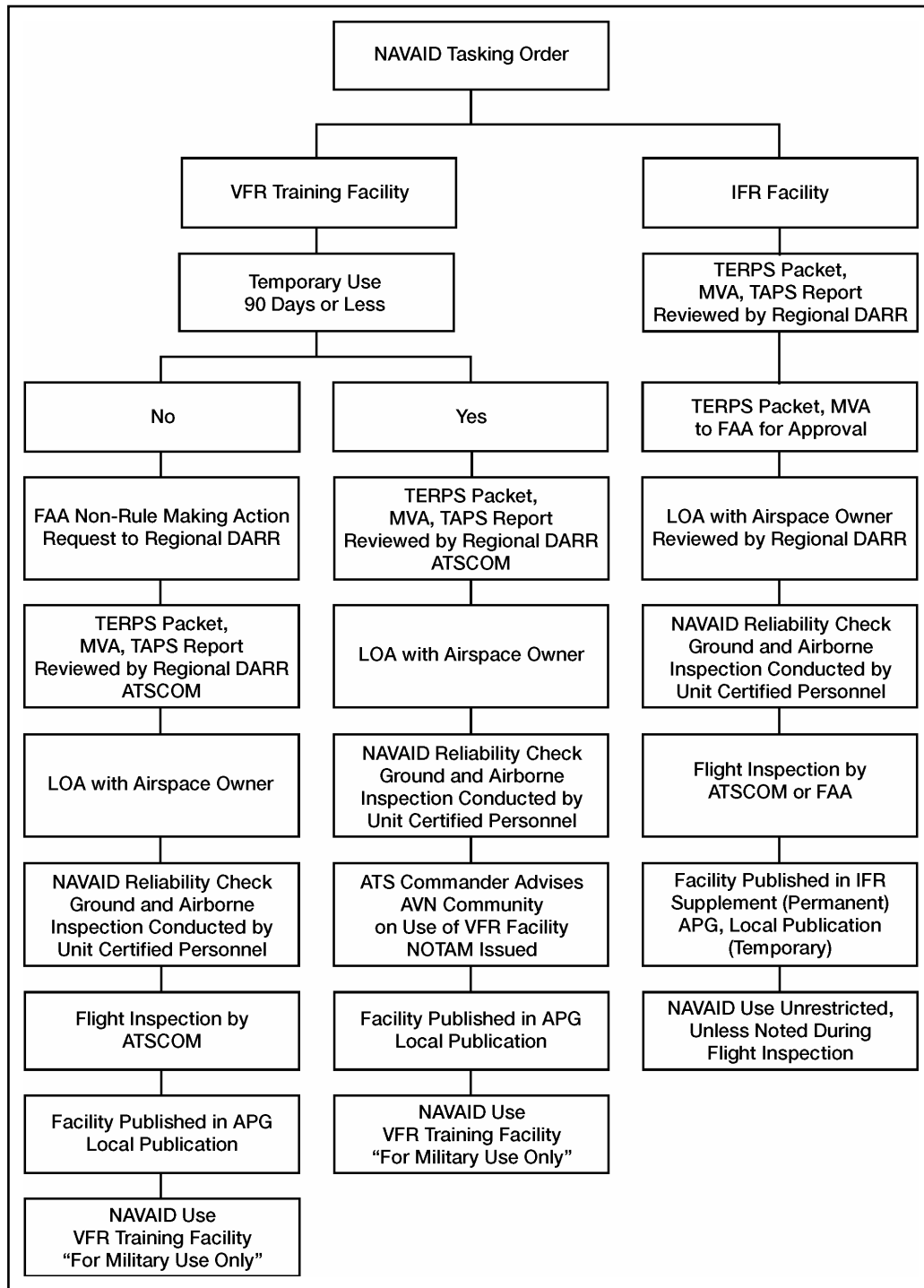

Figure G-3. Navigational Aid (NAVAID) Deployment Matrix

TERPS PACKETS

G-8. A TERPS packet shall be completed each time a NAVAID is installed for operational use. Instructions for completing each form in the packet are provided for clarification and guidance.

G-9. When the radar system is deployed for periods less than 90 days (VFR training/military use only), the packet sent to regional DARR/USAASD-E/ATSCOM shall include the following documents:

- FAA Form 7210-9 (*MVA Obstruction Document*).
- Minimum vectoring altitude chart (MVAC) drawn on two copies of the appropriate sectionals.
- DA Form 3501-1-R (*Precision Approach Radar [GCA] Data*).
- DA Form 3479-8-R.

G-10. When the radar is deployed for VFR/IFR use or for more than 90 days (VFR training), the packet sent to regional DARR/USAASD-E shall include the following documents.

- FAA Form 7210-9.
- Minimum vectoring altitude chart (MVAC) drawn on two copies of the appropriate sectionals.
- DA Form 3479-8-R.
- DA Form 3501-1-R.

G-11. DA Form 3501-1-R contains all the information required by USAASA/USAASD-E to have a terminal instrument approach procedure developed (see figure G-4). When ASR approaches are requested, the information contained in the PAR data sheet for the specific radar shall be used to develop the procedure. Instructions for completing DA Form 3501-1-R are as follows:

- **Item 1:** List the name of the airport/airfield/facility.
- **Item 2 through 5:** Self-explanatory.
- **Item 6a through 6d:** Provide the coordinates (6b and 6c) to the 1/100 second, and elevation (6d) to the 1/10 foot for the items listed in 6a. The numbered items correspond to the diagram in item 9.

PRECISION APPROACH RADAR (GCA) DATA			
For use of this form, see FM 3-04.303 the proponent agency is TRADOC.			
1. AIRPORT NAME Nowhere International		2. CITY Fort Sandy	
3. STATE No Where	4. COUNTRY USA	5. DATE 10 Jul 03	
6a. PAR COMPONENTS AND PERTINENT RUNWAY DATA (Numbered items correspond to the diagram in Item 9)	6b. LATITUDE	6c. LONGITUDE	6d. ELEVATION
	(1/100 Second)		(1/10 Feet)
(1) PAR Antenna Right of Runway	350754.55 N	785630.43 W	234.0
(1a) Touchdown Reflector/RPL Reflector Right of Runway	350754.55 N	785610.23 W	230.1
(2) PAR Antenna Left of Runway			
(2a) Touchdown Reflector/RPL Reflector Left of Runway			
(3) The point on runway centerline (C/L) closest to the touchdown reflector (RPI)	350751.51 N	785610.23 W	229.5
(4) Runway C/L End (Landing Threshold)	350751.51 N	785562.51 W	223.1
(5) Runway C/L End (Departure End of Runway)	350751.51 N	785658.61 W	235.6
(6) The point of runway closest to PAR Antenna (Offset)	350751.51 N	785630.43 W	233.9
(7) Displaced Threshold (if applicable)			
7. PAR GROUND DISTANCE (1/10 feet)			
a. 1 to 6 307.4	b. 1a to 3 307.4	c. 2 to 6	
d. 2a to 3	e. 3 to 4 641.2	f. 3 to 6 1677.8	
g. 3 to 7	h. 4 to 7	i. GEODETIC AZIMUTH 270 4 to 5 4659.8	
8. SHOW MAGNETIC NORTH ARROW HERE. Insert graphic image.			
			
9. DIAGRAM. Data referenced to WGS 84			
			
10. FACILITY CHIEF'S NAME, RANK, AND PHONE NUMBER Clubb, Timmy G. SFC DSN 555-5555		11. FACILITY CHIEF'S SIGNATURE //SIGN HERE//	

Figure G-4. Precision Approach Radar (GCA) Data

- **Item 7:** Information needed for 7a through 7i corresponds to the items under column 6a and the diagram in item 9. Provide the distance, to 1/10 foot, for each of the following items—
 - **7a:** If the PAR antenna (RT group) is placed on the right side of the runway, provide the distance from the PAR antenna to the point of runway closest to PAR antenna (offset).
 - **7b:** If the PAR antenna (RT group) is placed on the right side of the runway, provide the distance from the touchdown reflector or RPL reflector to the point on the runway centerline closest to the touchdown reflector. (Skip to 7e.)
 - **7c:** If the PAR antenna (RT group) is placed on the left side of the runway, provide the distance from the PAR antenna to the point of runway closest to PAR antenna (offset).
 - **7d:** If the PAR antenna (RT group) is placed on the left side of the runway, provide the distance from the touchdown reflector or RPL reflector to the point on the runway centerline closest to the touchdown reflector.
 - **7e:** Provide the distance from the point on the runway centerline closest to the touchdown reflector to the runway centerline end (landing threshold).
 - **7f:** Provide the distance from the point on the runway centerline closest to the touchdown reflector to the point of runway closest to PAR antenna (offset).
 - **7g:** If applicable, provide the distance from the point on the runway centerline closest to the touchdown reflector to the displaced threshold.
 - **7h:** If applicable, provide the distance from the runway centerline end (Landing Threshold) to the displaced threshold.
 - **7i:** Provide the distance from the runway centerline end (landing threshold) to the runway centerline end (departure end of the runway). Additionally provide the geodetic azimuth from point 4 to point 5. This is the magnetic heading of the runway.
- **Item 8:** Indicate with an arrow the direction of magnetic north in relation to the runway in item 9. If you are using formflow the arrow can be copied from PowerPoint and pasted in the box provided.
- **Item 9:** The Diagram is provided on the form for reference and requires no input from the controller.
- **Item 10 and 11:** Self-explanatory.

G-12. DA Form 3479-8-R, *Tactical Approach Publications System (TAPS)*, is used to distribute information on tactical NAVAIDS to supported units. The form should be completed and distributed early enough in the mission, that it is included in the aviation unit's aviation procedures guide (APG).

Appendix H

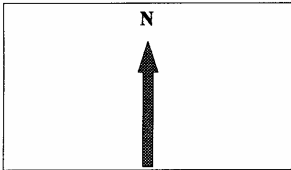
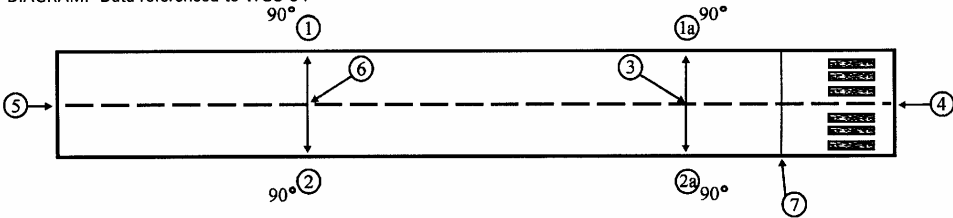
Determining Currency Requirements (Installation Facilities Only)

Pending revision of AR 95-2, which will include currency requirements previously contained in TC 95-93, use this appendix to determine currency requirements. A controller is current and may exercise the privileges of his/her rating when the following requirements are met.

H-1. Except for ATC chiefs, ATC SR SGTs and data systems officers, air traffic controllers shall remain current in the ATC facility to which assigned. Before becoming facility rated, a position-qualified individual may perform controller duties in those positions for which he is qualified. However, he must be under the general supervision of a controller who is facility rated and current in that facility.

H-2. To remain current in a tower/AIC facility, facility chiefs, training supervisors, and data system specialists shall demonstrate their ability to apply relevant procedures and techniques in actual operation of all functions and positions associated with the rating held, at least 24 hours per calendar month. This time shall be equitably distributed among all positions that are relative to the rating/position held. Half the time spent behind a trainee may count toward currency requirements.

H-3. To remain current in a tower/AIC facility, all other controllers shall demonstrate their ability to apply relevant procedures and techniques in actual operation of all functions and positions associated with the rating held, at least 40 hours per calendar month. This time shall be equitably distributed among all positions that are relative to the rating/position held. The time spent on a position monitoring a trainee will satisfy this requirement.

H-4. To remain current in the GCA, each controller shall conduct at least 10 PAR/ASR approaches per calendar month.

H-5. When a facility-rated controller is assigned a trainee and the amount of air traffic activity limits currency, the facility chief may allow the controller to count his approaches concurrently with those counted by the trainee controller receiving the one-on-one supervision. However, not more than five monitored or simulated approaches may be counted toward monthly currency.

H-6. Target simulations may also be used to fulfill up to 50 percent of the monthly currency approach requirements.

H-7. The provisions of H-1 and H-2 above shall not be applied concurrently to reduce the required number of approaches to less than five actual approaches. Time spent in a tactical situation performing the same types of duties for which the rating is held shall be counted for currency.

H-8. ARAC controllers are not required to conduct any set number of PAR approaches. ARAC facility chiefs are expected to establish currency requirements consistent with manning, training, and safety requirements. To remain current in an ARAC facility, controllers shall rotate each month through all positions on which they are rated. A minimum of 16 hours shall be spent on control or operational positions.

H-9. Every effort shall be expended to provide sufficient time, equipment, and training flights to ensure radar controllers meet operational and currency requirements.

H-10. When radar controllers have difficulty maintaining currency because of insufficient traffic, the airfield commander shall be advised in writing. Correspondence shall include the number of hours the facility can be adequately staffed and a request to provide the required number of approaches needed to maintain controller currency. If the controllers are unable to maintain currency, the airfield commander shall be advised, in writing, that a NOTAM should be issued stating what hours the facility will be out of service.

H-11. To maintain currency in two different facilities, dual-rated controllers must meet the currency requirements for the facility of assignment. When the second rating is in the tower/AIC, the controller must be present for duty in that facility not less than 24 hours each calendar month. If the second rating is in a GCA, five actual PAR/ASR approaches are required.

H-12. If a controller does not maintain currency, it will be noted on DA Form 3479-R with remarks as required.

H-13. An air traffic controller who has failed to maintain currency shall be given an evaluation to assess proficiency. The evaluation shall be administered on all control positions. The evaluation will be conducted under normal traffic conditions and last long enough to provide a reliable performance sample. It must be satisfactorily completed before the controller assumes position responsibility without direct supervision. The evaluation given for a loss of currency does not make the controller current for the month given. The evaluation only satisfies the proficiency requirements and allows the controller to continue working toward his currency requirements during the next 30 days, without direct one-on-one supervision. Evaluations for loss of currency will be administered by the ATC facility chief, training supervisor, or shift leader and retained for one year. The ATC chief or ATC SR SGT may administer the evaluation if facility-rated and current in the facility. The ATCS/CTO examiner may also administer the evaluation. The evaluation is recorded on DA Form 3479-1-R.

Determining Currency Requirements (Installation Facilities Only)

H-14. Remedial training shall be noted in sections III, IV, V, and VI of DA Form 3479-R, if additional training is needed to regain proficiency because of an unsatisfactory evaluation. The amount of training devoted to regaining proficiency should depend on the number and type of previous ratings the controller holds. Individuals unable to regain proficiency shall be processed in accordance with AR 95-2.

Glossary

A²C²	Army airspace command and control
A	adjacent (in formula)
AAC	Army approach control (nonradar)—an air traffic control facility located at a U.S. Army airfield or heliport. It provides approach control service without the use of radar.
AAF	Army airfield
AAR	after action report
AC	arrival control
ACA	airspace control authority—a service component commander designated by the joint force commander to plan and coordinate airspace control matters. The ACA also is responsible for the operation of the airspace control system in the airspace control area. As used in this publication, the airspace control authority is the Air Force component commander (AFCC) or the Commander Air Forces (COMAFFOR).
ACM	airspace control measure
ACO	airspace control order—a document that details all approved airspace requests. It complements the air tasking order (ATO) cycle and serves as the one planning document for airspace considerations.
act	actual
AD	air defense
ADIZ	air defense identification zone
AHP	Army heliport
AIC	Airspace information center—formerly flight coordination center, flight operations center, or Army flight-following service—an ATC facility used in the corps/division area to provide flight-following services and air warning advisories and assist in search and rescue operations
AIG	address indicating/indicator group
AIM	aeronautical information manual
air carrier	a civil aircraft certified to operate and serve the public interest by transporting people and cargo for scheduled and unscheduled operations
air taxi	a term used to describe helicopter or vertical takeoff and landing (VTOL) aircraft movement conducted above the surface. However, air traffic movement is not above 100 feet above ground level (AGL). The aircraft may proceed either by hover taxi or flight at speeds of more than 20 knots. The pilot is solely responsible for selecting a safe airspeed and altitude for the operation being conducted.

airspace control	a service provided within the combat zone to maximize combat effectiveness. It does so by promoting safe, efficient, and flexible use of airspace. Airspace control permits flexibility of actions in controlled airspace. Authority to approve, disapprove, or deny combat operations is vested only in the joint force commander.
airspace management	the coordination, integration, and regulation of the use of airspace of defined dimensions
AIT	advanced individual training
AL	Alabama
ALE	automated link establishment
ALSF-1	high-intensity approach lighting system
AM	amplitude modulation
ANCD	automated net control devices
ANCOC	Advanced Noncommissioned Officer Course
AOC	air operations center
AP	approach control
APG	aviation procedures guide
APM	approach path monitor
AR	Army regulation
ARAC	Army radar approach control
ARIMS	Army records information management system (formerly MARKS)
ARNG	Army National Guard
ARR	arrival
ARTCC	air route traffic control center
ARTEP	Army training and evaluation program
ARTS	Automated Radar Terminal System
ARTS II	Automated Radar Terminal System (ARTS) II—a programmable, nontracking, computer-aided display subsystem capable of modular expansion. ARTS II provides a level of automated ATC capability at terminals with low-to-medium activity. Flight identification and altitude may be associated with the display of secondary radar targets. Flight plan information also may be exchanged between the terminal and the air route tactical control center (ARTCC).
asgd	assigned
ASHRAE	American Society of Heating, Refrigeration, and Air Conditioning Engineers
ASI	additional skill identifier

ASR	airport surveillance radar—the approach control radar used to detect and display an aircraft position in the terminal area. It provides range and azimuth information but does not provide elevation data. Final ASR—an instrument or visual approach wherein the air traffic controller issues instructions to the pilot. The instructions are based on the aircraft position in relation to the final approach course (azimuth) and the distance (range) from the end of the runway as displayed on the controller's radar indicator.
AT	annual training
AT&A	air traffic and airspace
AT&AO	air traffic and airspace officer
ATC	air traffic control/controller
ATCS	air traffic control section, air traffic control specialist
ATC SR SGT	air traffic control senior sergeant
ATCRBS	air traffic control radar beacon system
ATCSS	air traffic control signaling system
ATCT	airport traffic control tower
ATSCOM	Air Traffic Services Command
ATIS	automatic terminal information service
ATNAVICS	air traffic navigation, integration, and coordination system
ATO	air tasking order—the document that implements tactical air support. The order tasks assigned and attached units to accomplish specific missions to support the objectives of the joint force commander. The combat plans division of the air operations center (AOC) publishes the ATO daily. The order provides sufficient detail to enable mission aircrew and theater air-ground system (TAGS) elements to execute assigned missions.
ATS	air traffic services
ATTN	attention
avn	aviation
AWDS	Automated Weather Distribution System
AWS	air weather service
baluns	impedance-matching transformers
BNCOC	Basic Noncommissioned Officer Course
BTU	British Thermal Unit
C²	command and control
C	Centigrade; concept
CA	conflict alert
C-AIC	corps airspace information center
CBO	callback only (responsibility code)
CCU	communication control unit

CD	clearance delivery; combat developer
CDT	cumulative downtime
CECOM	Communications-Electronics Command
certification	the technical verification that the system/subsystem/equipment provides the required or advertised services to the user (air traffic personnel or the aviation community) after commissioning. The verification is followed by the prescribed written entry in the official facility maintenance log. Certification includes the independent determination as to when the system/subsystem equipment should be either continued or removed from service.
certification authority	consists of the appropriate documentation in the certification and training records of the satisfactory completion of the theory and performance requirements according to the directive on the pertinent system/subsystem/equipment. The certification authority may be exercised only after the assignment in, writing of, specific responsibilities in the certification/training records.
certification record	DA Form 3479-9-R (<i>ATC Certification and Related Training Record</i>)
certification responsibility	responsibility consisting of the accountability for determining and documenting the operational status of specific systems/ subsystems/equipment in the official facility maintenance log.
CFM	cubic feet per minute (obsolete); use ft ³ /min
CI	coordinator
CIC	commander-in-chief; controller in charge
CM	configuration management
co	company
COMSEC	communications security
controller	person authorized to provide ATC service
CONUS	continental United States
CRC	control and reporting center—an element of the theater air – ground system (TAGS) from which air defense, radar control, and warning operations are conducted within its area of responsibility. The CRC supervises the activities of subordinate units. It collects, displays, evaluates, and disseminates information on air activities throughout the TAGS. The CRC provides defensive and offensive mission control, navigational and air rescue assistance, and threat warning for friendly aircraft. The CRC provides the means for air traffic regulation and identification coordination of air defense activities. It is the primary control agency in the airspace control area or sector.
CTA	common table of allowance
CTO	control tower operator
current	Controller is current and may exercise the privileges of their rating when they meet the requirements of appendix H, paragraph H-2 through H-4

currency	signifies that a person has met all the requirements for performing the duties associated with a particular facility rating
CXAM	concept exam
DA	Department of the Army
DAC	Department of the Army civilian
D-AIC	division airspace information center
DARR	Department of the Army regional representative
DAT	digital audio tape
dB	decibel
DBRITE	digital bright radar indicator tower equipment
DCA	Deputy Chief of Staff
DC	departure control
DEP	departure
DH	decision height
direct	(one-on-one) supervision provided by a facility-rated, current/proficient supervisor or controller who is assigned to a control position with an individual who is not position-qualified or proficient at that control position
DME	distance measuring equipment
DMOS	duty military occupational specialty
DNIF	duties not to include flying
DOD	Department of Defense
DSN	defense switching network
DSO	data systems officer
DSS	direct support system; data systems specialist
DTM	digital terrain map
DTS	date training starts
DVRS	digital voice recorder system
E	equipment; enlisted
ECCM	electronic counter-countermeasures
ECHUM	electronic chart updating manual
ECM	electronic countermeasures
ECU	electronic control unit
EDA	estimated date of arrival
EDR	expect departure release; estimated date of return
EIP	engineering installation package
EMC	electromagnetic compatibility
emerg	emergency
EML	emergency manning level
EOD	explosive ordnance disposal; explosive ordnance demolition

ETA	estimated time of arrival
ETS	expiration term of service
ETVS	enhanced tower voice switch
EUSA	Eighth United States Army
examiner	an ATC maintenance person designated, in writing, to monitor and conduct examinations
exp	experience
F	Fahrenheit; failed
FAA	Federal Aviation Administration
facility rating	an endorsement on a control tower operator (CTO) or an air control specialist (ATCS) certificate that signifies the applicant has demonstrated the competence, qualifications, and skills required to control air traffic at a given location. A certificate, along with the rating, is issued to the applicant to confirm the rating and grant certain privileges. It may prescribe certain limitations according to the Federal Aviation Act, Federal aviation regulations (FAR), and Army regulations.
FAR	Federal aviation regulations
FARP	forward area rearming/refueling point
FBPAR	fixed wing precision approach radar
FC	full certification for complete service (responsibility code)
FCC	Federal Communication Commission.
FD	flight data
FDB	Fahrenheit dry bulb
FDIO	flight data entry and printout equipment
FF	flight following
FFD	full flying duties
FI	flight inspection
FIC	full installation certification (responsibility code)
FIR	facility inspection responsibility (responsibility code)
FLIP	flight information publication
FM	field manual, frequency modulation
FOIA	Freedom of Information Act
FPN	fixed pulse radar navigation aid
FS	full stop
FSC	front supply classification
FSS	flight service station
ft	foot/feet
FTM	facility training manual
FTP	facility training program
FTX	field training exercise

FWB	Fahrenheit wet bulb
G3	Assistant Chief of Staff, G3 (Operations and Plans)
GC	ground control
GCA	ground-controlled approach—a radar approach system operated from the ground by ATC personnel transmitting radio instruction to a pilot. The approach may be conducted with airport surveillance radar (ASR) only or with both surveillance and precision approach radar (PAR). The use of the term GCA by pilots is discouraged except when they are referring to a GCA facility. Pilots should specifically request either a PAR approach when they desire a precision radar approach or an ASR or a surveillance approach when they desire a nonprecision radar approach.
gd	grounding
general aviation	the portion of civil aviation that includes all facets of aviation except air carriers
general supervision	supervision provided by the shift supervisor or controller in charge (CIC) to ensure the efficient operation of the facility .
GPI	ground plane intercept
GPS	global positioning system
GS	general support; general schedule
GTM	general terrain map
HF	high frequency
HIRLS	high-intensity runway lighting system
HQ	headquarters
Hz	hertz
I	interim
IAW	in accordance with
ICAO	International Civil Aviation Organization
ID	identification
IFF	identification, friend or foe (radar)
IFR	instrument flight rules—rules that govern the procedures for conducting instrument flight. The term “IFR” is also used by aviators and controllers to indicate the type of flight plan filed
ILS	instrument landing system
IMC	instrument meteorological conditions—meteorological conditions expressed in terms of visibility, the distance from clouds, and the ceiling. They are less than the minima specified for visual meteorological conditions (was IFR).
improv	improvement
init	initial
installation	one or more ATS facilities, located on an Army airfield or heliport,

facilities	which provides air traffic control particular functions (formerly named fixed-base ATC facilities)
intro	introduction
JAC²C	Joint Airspace Command and Control Course
JAOS	joint air operations staff
JFCC	Joint Firepower Control Course
JO	job order
kv	kilovolt
kw	kilowatt
KHz	kilohertz
LA	low approach
LAT	latitude
LC	local control, limited certification (responsibility code)
LNO	liaison officer
LOA	letter of agreement
LONG	longitude
LOP	letter of procedure
emg lv	emergency leave
LWO	limited weather observation
LZ	landing zone
MA	missed approach
MACOM	major Army command
maint	maintenance
MALS	medium intensity approach light system
MAP	missed approach point
MDA	minimum descent altitude (now MAP)
med	medical
METAR	meteorological aviation report
MHz	megahertz
military aircraft	rotary-wing and fixed-wing airframes under the jurisdiction of the U.S. military, foreign military, or U.S. Coast Guard
MIRLS	medium-intensity runway (edge) lights
MMS	meteorological measuring system
MOA	military operations area
MOS	military occupational specialty
MRA	minimum reception altitude
M/S	monitored and/or simulated
MSA	minimum safe altitude
MSAW	minimum safe altitude warning
MSL	mean sea level

MVA	minimum vectoring altitude
MVAC	minimum vectoring altitude charts
MWOD	multiple word of day
N	north
NAS	National Airspace System
NATO	North Atlantic Treaty Organization
NAVAID	navigational aid
NCO	noncommissioned officer
NDB	nondirectional radio beacon
NIMA	National Imagery and Mapping Agency
NM	nautical miles
no	number
NOE	nap-of-the-earth
no-Gyro	a radar approach/vector provided in case the gyrocompass or directional gyro malfunctions. Instead of providing the pilot with headings to be flown, the controller observes the radar track and issues the control instructions “turn right/left” or “stop turn,” as appropriate.
NOTAM	notice to airmen
NSN	national stock number
NTFYD	notified
NTRN	nonresident training
NVD	night vision device
NVG	night vision goggles
NVIS	near vertical incidence sky wave
O	opposite (in formula)
OCE	Office, Chief of Engineer
OCONUS	outside continental United States
ODALS	omnidirectional approach lights system
OJT	on-the-job training
OPM	Office of Personnel Management
ops	operations
OTS	out of service
overflights	aircraft that receive Army ATC services while overflying or transiting a facility area of responsibility.
P	proficiency (as in type of training)
pam	pamphlet
PAO	public affairs office
PAPI	precision approach path indicator

PAR	precision approach radar—a precision instrument approach wherein the air traffic controller issues guidance for aviator compliance. The instruction is based on the aircraft position in relation to the final approach course (azimuth), the glide slope (elevation), and the distance (range) from the touchdown point on the runway, as displayed on the controller’s radarscope.
final PAR	a PAR approach wherein the controller issues instructions to the pilot. Instructions are based on the aircraft position in relation to the final approach course (azimuth), the glide slope (elevation), and the distance (range) from the touchdown point on the runway as displayed on the radar indicator. This count shall also be used to record radar-monitored, nonradar approaches (such as ILS approaches).
PC	prior certification, personal computer
PCS	permanent change of station
PEXAM	performance examination— an examination designed to test the ATC maintenance technician’s proficiency by means of a practical hands-on demonstration on the particular system/subsystem/equipment
PIREPS	pilot reports
PLDC	Primary Leadership Development Course
PLL	prescribed load list
PMCS	preventive maintenance checks and services
PMOS	primary military occupational specialty
POI	program of instruction
POL	petroleum, oil, and lubricants
position qualification	a term that attests that an individual has mastered the knowledge and skills required to operate independently at a specific ATC operating position. It is one step in the process of obtaining a facility rating
positive control	the operation of air traffic in a radar/nonradar control environment in which positive identification, tracking, and direction of aircraft within an airspace are conducted by an agency having the authority and responsibility therein
PQ	position-qualified
PSG	platoon sergeant
PUA	positive urinalysis
PZ	pickup zone
Q	qualification
QA	quality assurance
qual	qualification
qualified controller	a facility-rated controller or one who is position-qualified on one or more controller positions
R	remedial; record; reproducible

radar approach	an instrument approach procedure that uses PAR or ASR
RAIL	runway alignment indicator lights
R-AST	regular workload—assistance as assigned by supervisor (responsibility code)
R-ASTCS	regular workload—and/or callback as assigned by supervisor (responsibility code)
RCO	remote communication outlet
RCP	reception center processing
RDP	radar data processing
reclas	reclassification
reg	regulation
REQ	request
rev	revision
RH	relative humidity
RF	radio frequency
RPI	runway point of intercept
RPV	remotely piloted vehicle
RSC	radio set controls
RSP	reconnaissance and security positions
RT	radar tracking; receiver/transmitter
RTRN	return resident training
RTS	return to service
RVR	runway visual range
RWA	regular workload assignments (responsibility code)
RWCS	regular workload and callback responsibility (responsibility code)
SAAFR	standard use Army aviation flight route
SALS	short, high-intensity approach lighting system
SARSAT	search and rescue satellite-aided tracking
sat	satisfactory
SAVES	safe aviation via exceptional service
SD	special duty
SEIP	standard engineering installation package
SHAPE	Supreme Headquarters Allied Powers Europe
SID	standard instrument departure
SIF	selective identification feature
SINCGARS	Single-Channel Ground and Airborne Radio System
SJA	Staff Judge Advocate
SL	shift leader
SOI	signal operation instructions

SOP	standing operating procedure
SPECI	special observation
SPC	specialist
SR	senior
SS	shift supervisor
SSALR	simplified short approach lighting system with runway alignment indicator
SSALS	simplified short approach lighting system
SSB	single side band
SSC	subsystem certification (responsibility code)
SSG	staff sergeant
SSN	Social Security number
STAF	duties as assigned by facility maintenance chief (responsibility code)
STARS	SHAPE Technical Center Adaptable Radar Simulator
SUA	special use airspace
supv	supervisor
SVFR	special visual flight rules
SWOD	single word of day
T	trainee; tangent (in formula)
TAC	tactical air commander
TACAN	tactical air navigation
TAN	tangent
TAPS	tactical approach publication system
TC	training circular; quantity of air outlets (in formula)
TD	touchdown
TDA	table(s) of distribution and allowances
TDY	temporary duty
TDZE	touchdown zone elevation
TE	quantity of air outlets (in formula)
terneplate	lead-tin alloy coating
TERP	terminal instrument procedures
TG	touch and go
TM	technical manual
TMDE	test, measurement, and diagnostic equipment
TOC	tactical operations center, technical order compliance, theater of operations command
TOE	table of organization and equipment
TPN	tactical packet network
TPX	military beacon system

TR	computed air quantity (in formula)
TRADOC	U.S. Army Training and Doctrine Command
T/SIP	tactical/standard instrument procedures
TTCS	tactical terminal control system
TTE	training time extended
TTR	training time resumed, target tracking radar, time to repair, total tank requirement
TTS	training time stopped
TVO	tower visibility observations
TVOR	terminal VHF omnidirectional range
TWR	tower; aerodrome control tower
UH	utility helicopter
UHF	ultra high frequency
UNK	unknown
unsat	unsatisfactory
UPS	uninterrupted power supply
U.S.	United States
USA	U.S. Army, United States of America
USAASA	U.S. Army Aeronautical Services Agency
USAASD-E	U.S. Army Aeronautical Service Detachment—Europe
USAAVNC	U.S. Army Aviation Center
USAF	U.S. Air Force
USAISC	U.S. Army Information Systems Command
USAR	U.S. Army Reserve
USFK	U.S. Forces, Korea
UTC	coordinated universal time
ATSCOM	Air Traffic Services Command, formerly U.S. Army Air Traffic Control Activity (USAATCA)
VASI	visual approach slope indicator
VFR	visual flight rules—the rules that govern the procedures for conducting flight under visual conditions. The term VFR is used in the United States to indicate weather conditions equal to or greater than, minimum VFR requirements. The term is also used by pilots and controllers to indicate the type of flight plan.
VFR operations	operations conducted according to visual flight rules
VHF	very high frequency
VOR	very high frequency omnidirectional range
VORTAC	very high frequency omnidirectional range (VOR) and tactical air navigation (TACAN) (collocated)
WBGT	wet bulb globe temperature

w/chgs	with changes
WG	wage grade (civilian employee)
WX	weather

Bibliography

REQUIRED PUBLICATIONS

ARMY PUBLICATIONS

- AR 25-50, *Preparing and Managing Correspondence*, 3 June 2002.
- AR 25-55, *The Department of the Army Freedom of Information Act Program*, 14 April 1997.
- AR 70-1, *Army Acquisition Policy*, 15 December 1997.
- AR 25-400-2, *The Army Records Information Management System (ARIMS)*, 18 March 2003.
- AR 40-8, *Temporary Flying Restrictions Due to Exogenous Factors*, 17 August 1976.
- AR 40-501, *Standards of Medical Fitness*, 30 September 2002.
- AR 95-1, *Flight Regulations*, 1 September 1997.
- AR 95-2, *Air Traffic Control, Airspace, Airfields, Flight Activities and Navigation Aids*, 10 August 1990
- AR 115-10, *Weather Support for the U.S. Army (AFJI 15-157)*, 30 June 1996.
- AR 115-11, *Geospatial Information and Services*, 10 December 2001.
- AR 190-51, *Security of Unclassified Army Property (Sensitive and Nonsensitive)*, 30 September 1993.
- AR 310-49, *The Army Authorization Documents System (TAADS)*, 15 December 1980.
- AR 385-10, *The Army Safety Program*, 23 May 1988.
- AR 385-95, *Army Aviation Accident Prevention*, 10 December 1999.
- AR 420-90, *Fire and Emergency Services*, 10 September 1997.
- AR 700-138, *Army Logistics Readiness and Sustainability*, 16 September 1997.
- AR 710-2, *Inventory Management Supply Policy Below the Wholesale Level*, 31 October 1997.
- AR 725-50, *Requisition, Receipt, and Issue System*, 15 November 1995.
- AR 735-5, *Policy and Procedures for Property Accountability*, 10 June 2002.
- AR 750-1, *Army Materiel Maintenance Policy and Retail Maintenance Operations*, 1 August 1994.
- AR 750-43, *Army Test, Measurement and Diagnostic Equipment Program*, 28 November 1997.
- ARTEP 1-425-MTP, *Air Traffic Control Battalion*, 5 April 1996.

- DA Pam 25-30, *Consolidated Index of Army Publications and Blank Forms*, 1 April 2003.
- DA Pam 25-50, *Compilation of Army Addresses*, 3 September 2002.
- DA Pam 611-21, *Military Occupational Classification and Structure*, 31 March 1999.
- DA Pam 710-2-1, *Using Unit Supply System (Manual Procedures) (Standalone Publication)*, 31 December 1997.
- DA Pam 710-2-2, *Supply Support Activity Supply System: Manual Procedures*, 30 September 1998.
- DA Pam 738-750, *Functional Users Manual for the Army Maintenance Management System (TAMMS)*, 1 August 1994.
- DA Pam 750-10, *U.S. Army Equipment Index of Modification Work Orders*, 1 August 1989.
- DA Pam 750-35, *Guide for Motor Pool Operations*, 1 August 1994.
- FM 1-100, *Army Aviation Operations*, 21 February 1997 (will be revised as FM 3-04.100).
- FM 1-120, *Army Air Traffic Services Contingency and Combat Zone Operations*, 22 May 1995 (will be revised as FM 3-04.120).
- FM 3-52 (FM 100-103), *Army Airspace Command and Control in a Combat Zone*, 1 August 2002
- FM 3-100.2 (FM 100-103-1), *ICAC2 Multiservice Procedures for Integrated Combat Airspace Command and Control*, 30 June 2000.
- FM 4-25.11 (FM 21-11), *First Aid for Soldiers*, 23 December 2002
- FM 4-30.3 (FM 9-43-1), *Maintenance Operations and Procedures*, 1 September 2000.
- FM 7-0 (FM 25-100), *Training the Force*, 22 October 2002.
- FM 11-486-23, *Telecommunications Engineering for Air Traffic Control Facilities and System*, 15 October 1979.
- FM 11-487-4, *Installation Practices: Communications Systems Grounding, Bonding and Shielding*, 28 December 1987.
- FM 22-100, *Army Leadership*, 31 August 1999 (will be revised as FM 6-22).
- FM 24-2, *Spectrum Management*, 21 August 1991 (will be revised as FM 6-02.70).
- FM 25-101, *Battle Focused Training*, 30 September 1990 (will be revised as FM 7-1).
- FM 3-0 (FM 100-5), *Operations*, 14 June 2001.
- FM 3-21.38 (FM 57-38), *Pathfinder Operations*, 1 October 2002.
- FM 100-103-2, *TAGS Multiservice Procedures for Theater Air-Ground System*, 29 July 1998 (will be revised as FM 3-52.2).
- FM 101-5, *Staff Organization and Operations*, 31 May 1997 (will be revised as FM 5-0).

- MIL-STD-188-124, *Grounding, Bonding and Shielding for Common Long Haul/Tactical Communications System Including Ground Based Communications-Electronics Facilities and Equipment*, 1 May 1998.
- MIL-STD-1472B, *Human Engineering Design Criteria for Military Systems, Equipment and Facilities*, 31 December 1974.
- MIL-STD-1472D, *Human Engineering Design Criteria for Military Systems Equipment and Facilities*, 14 March 1989.
- TB 11-6625-3263-25, *Test Equipment Modernization (TEMOD) Program Guide and Replacement Lists*, 12 September 2000.
- TB 43-118, *Field Instructions for Painting and Preserving Communications-Electronics Equipment*, 16 June 1986.
- TB 43-129, *Safety Requirements for Use of Antenna and Mast Equipment*, 15 June 1986.
- TB 43-180, *Calibration and Repair Requirements for the Maintenance of Army Materiel*, 15 September 2002.
- TB 385-4, *Safety Requirements for Maintenance of Electrical and Electronic Equipment*, 1 August 1992.
- TB 750-25, *Maintenance of Supplies and Equipment: Army Test, Measurement and Diagnostic Equipment (TMDE) Calibration and Repair Support (C&S) Program*, 1 March 1997.
- TB Med 523, *Control of Hazards to Health from Microwave and Radio Frequency Radiation and Ultrasound*, 15 July 1980.
- TB Sig 222, *Soldier and Soldiering*, 5 March 1985.
- TC 95-93, *Air Traffic Control Facility Operations and Training*, 22 March 1989.
- TM 5-803-7, *Airfield and Heliport Planning and Design*, 1 May 1999.
- TM 9-6140-200-14, *Operator's, Unit, Direct Support and General Support Maintenance Manual for Lead-Acid Storage Batteries; 4HN, 24 Volt (Dry) (NSN 6140-00-059-3528) M11188/2-24V; 4HN, 24 Volt (Wet) (6140-01-396-1968) M11188/2-24V; 2HN, 12 Volt (Dry) (6140-00-057-2553) MS35000-2; 2HN, 12 Volt (Wet) (6140-01-390-1969) MS35000-2; 6TN, 12 Volt (Dry)*, 11 November 1998.
- TM 95-225, *United States Standard: Flight Inspection (NAVAIR 16-1-520; AFM 55-8; FAA OA-P8200.1)*, 1 May 1963.
- TM 95-226, *United States Standard For Terminal Instrument Procedures (TERPS) (OPNAVINST 3722.16C; AFM 55-9; FAA HDBK 8260.3B)*, 7 July 1976.

RELATED PUBLICATIONS

FORMS

- DA Form 2028, *Recommended Changes to Publications and Blank Forms*, (DA Form 4569).

- DA Form 2696-R (DA Form 2696), *Operational Hazard Report*.
- DA Form 3479-R, *Training and Proficiency Record—Air Traffic Controller (LRA)*.
- DA Form 3479-1-R, *Trainee/Controller Evaluation (LRA)*.
- DA Form 3479-6-R, *ATC Facility and Personnel Status Report*, March 1989.
- DA Form 3479-8-R, *Tactical Approach Publications System*.
- DA Form 3479-9-R, *ATC Maintenance Personnel Certification and Related Training Record*.
- DA Form 3479-10-R, *Responsibility Assignment*.
- DA Form 3479-11-R, *Tactical Facility Training Program (FTP) AN/TSQ-198 Tactical Terminal Control System*.
- DA Form 3479-12-R, *Tactical Facility Training Program (FTP) AN/GRC-206 Tactical Tower System*.
- DA Form 3479-13-R, *Tactical Facility Training Program (FTP) AN/TSC-61B Airspace Information Center*.
- DA Form 3479-14-R, *Tactical Facility Training Program (FTP) AN/TSQ-221 Tactical Airspace Integration System (TAIS)*.
- DA Form 3479-15-R, *Tactical Facility Training Program (FTP) AN/TSW-7A Air Traffic Control Central*.
- DA Form 3479-16-R, *Tactical Facility Training Program (FTP) AN/TSQ-71B Landing Control Central*.
- DA Form 3479-17-R, *Tactical Facility Training Program (FTP) AN/TPN-31 Air Traffic Navigation Integration and Coordination System (ATNAVICs)*.
- DA Form 3479-18-R, *Tactical Facility Training Program (FTP) AN/TSQ-70A Tactical Tower System*.
- DA Form 3479-19-R, *Tactical Facility Training Program (FTP) AN/TSQ-97A Tactical Tower System*.
- DA Form 3501-R, *GCA Operations Log*.
- DA Form 3501-1-R, *Precision Approach Radar (GCA) Data*.
- DA Form 3502-R, *Daily Report of Air Traffic Control Facility* (DA Form 4569).
- DA Form 3503-R, *Air Traffic Control Position Log*.
- DA Form 4186, *Medical Recommendation for Flying Duty*.
- DD Form 1556, *Request, Authorization, Agreement, Certification of Training and Reimbursement*.
- FAA Form 7210-9, *En Route Minimum IFR/Minimum Vectoring Altitude Obstruction Document*.

FAA Form 7230-7, *Flight Progress Strip, Terminal-Continuous With Center Performance*
(DA Form 3501-R).

FAA Form 7230-8, *Flight Progress Strip, Terminal-Cut.*

FAA Form 7230-21, *Flight Progress Strip, Flight Service Station (FSS).*

FAA Form 7460-2, *Notice of Actual Construction or Alteration Form.*

FAA Form 8240-22, *Facility Data Sheet.*

FUTURE PUBLICATIONS

National Fire Protection Association (NFPA) Life Safety Code 101, 17 October 2003

OTHER PUBLICATIONS

AFJI 15-157, *Meteorological Support for the Army*, 23 April 1990.

AFM 32-1076 (AFR 88-14), *Design Standards for Visual Air Navigation Facilities*,
1 December 1997.

American National Standards Institute Regulation A14.3-1992
(<http://www.navfac.navy.mil/safety/site/topics/ladders.htm>)

International Civil Aviation Organization Manual 7910, *Location Indicators*.
(<http://www.nws.noaa.gov/oso/site.shtml>)

JP 3-52, *Joint Doctrine for Joint Airspace Control in the Combat Zone*, 22 July 1995.

Title 14, Code of Federal Regulations (CFR), Aeronautics and Space, Part 91.209, *General
Operating and Flight Rules–Aircraft Lights*.
(<http://www.swissalpa.ch/organisation/ faa/FAR-91.html#Sec.%2091.209>)

National Imagery and Mapping Agency (NIMA), *Electronic Chart Updating Manual
(ECHUM)*, May 2003
(<http://164.214.2.62/products/webchum/index.cfm>)

FAA Handbook 7340.1, *Contractions*, (Change 3, 20 March 2003).

FAA Advisory Circular 70/7460-1, *Obstruction Marking and Lighting*, 15 April 2000.

Federal Aviation Regulations, Part 65.47 *Certification: Airmen Other Than Flight
Crewmembers*, 10 August 1962.

FAAO 6000.6, *United States Interagency Ground Inspection Manual*, 1 April 1967.

FAAO 6000.15, *General Maintenance Handbook for Airway Facilities*, 11 August 2000.

FAAO 6310.19, *Maintenance of the Airport Surveillance Radar*, February 1999.

FAAO 6360.1, *Maintenance of Air Traffic Control Beacon Interrogator*, 16 May 1979.

FAAO 6470.29, *Maintenance of Enroute Air to Ground Communications Facilities*,
7 August 1985.

FAAO 6480.6, *Maintenance of Terminal Air Traffic Control Air to Ground Facilities*,
20 June 1990.

- FAAO 6670.13, *Maintenance of Digital Voice Recorder (DVR) Equipment*, 6 December 1999.
- FAAO 6700.14, *Ground Certification of Non-FAA Federally Owned (Non Military) Navigational Aid(s)*, 27 November 1968
- FAAO 6700.20, *Non-Federal Navigational Aids and Air Traffic Control Facilities*, 13 November 1995.
- FAAO 6730.2, *Maintenance of DME Facilities*, 21 April 1989.
- FAAO 6740.2, *Maintenance of Non-Directional Beacons*, 6 March 1989.
- FAAO 6750.49, *Maintenance of Instrument Landing System (ILS) Facilities*, 2 June 1987.
- FAAO 6770.2, *Maintenance of 75MHz Fan Marker (FM) Facilities*, 5 June 1989.
- FAAO 6820.7, *Maintenance of Navigational Aids, Facilities and Equipment – VOR, VOR/DME, VORTAC*, 1 December 1995.
- FAAO 7110.10, *Flight Services*, (Change 1, 8 August 2002; Change 2, 20 Feb 2003), 21 February 2002.
- FAAO 7110.65, *Air Traffic Control*, (Change 1, 8 August 2002; Change 2, 20 February 2003), 21 February 2002.
- FAAO 7210.3, Chapter 3, *Facility Operation and Administration*, (Change 1, 8 August 2002; Change 2, 20 February 2003), 21 February 2002.
- FAAO 7220.1, *Certification and Rating Procedures*, 18 August 1996.
- FAAO 7400.2, *Procedures for Handling Airspace Matters*, (Change 1, 7 July 2001; Change 2, 25 July 2002), 7 December 2000.
- FAAO 7610.4, *Special Military Operations*, (Change 1, 3 July 2000; Change 2, 12 July 2001), 3 November 1998.
- FAAO 8020.11, *Aircraft Accident and Incident Notification, Investigation, and Reporting*, 16 August 2000. (http://www1.faa.gov/avr/aai/8020_11b.pdf)
- FAAO 8080.1, *Conduct of Airmen Written Tests*, 25 August 1971.
- FAAO 8200.1, *United States Standard Flight Inspection Manual*, 1 May 1996.
- FAAO 8260.3, United States Standard for *Terminal Instrument Procedures (TERPS) (AFJMAN 11-226)*, 1 November 1999.
- FAAO 8260.19, Chapter 3, sections 7 and 9, *Facility Operation and Administration—Facility Equipment—Radar Use and Radar Vectoring*, 16 September 1993.
- FAR 91.171, *VOR Equipment Check for IFR Operations*, 28 April 2003.
- FM 3-04.500 (FM 1-500). *Army Aviation Maintenance*. 26 September 2000.
- Office of Personnel Management (OPM) Handbook X-118, *Qualification Standards for Positions Under the General Schedule*, January 1975.

United Facilities Code 3-260-01, *Airfield and Heliport Planning and Design*.

U.S. Army Air Traffic Control Activity, (<http://155.147.98.10/atca/home/ATCHOME.htm>)

U.S. Army Aeronautical Services Agency, <http://www.usaasa.belvoir.army.mil/Default.htm>

Index

A

accidents/incidents, 2-15
air traffic services (ATS)
leaders, 2-16
aircraft involvement, 2-15
radar facilities, 2-17
shift leader, 2-16
administrative
correspondence
facility memorandums, 5-11
letters of agreement (LOA),
5-4
letters of procedure (LOP),
5-7
operations letters, 5-10

C

certification, 1-2
authority, 8-7
maintenance technician, 8-8
objectives-ATC, 8-7
responsibility, 8-7
theory of operation and
performance, 8-10
classification, 1-3
communications, 2-7
currency, 2-8
currency requirements
(installation facilities only),
H-1

D

duty
positions, 2-1
responsibilities, 2-1

E

equipment
layouts, 4-1
examinations
failure policy, 8-13
performance, 8-12
review and evaluation, 8-13
theory (concepts), 8-11

F

facility
administration, 2-1
air traffic control, 4-4
certification, 4-3
control/coordination, 2-14
equipment, 4-1
ground inspection, 4-3
navigational aids (NAVAID),
4-12
radar system (installation
Facilities only), 4-5
recertification, 4-3
Federal Aviation
Administration (FAA)
academy training, 1-2
flight
magnetic variations, 3-15
procedures, 3-17
responsibilities, 3-16
following services, 3-1
flight, 3-16
radar, 3-1
forms
controller training and
proficiency record, A-2
related training record, A-47
responsibility assignment, A-
47

G

ground inspection
certification
procedures, 8-2
responsibility, 8-1

I

inspections
75 MHz marker beacons, 8-
4
communication facilities, 8-6
glide scope, 8-4
instrument landing system
(ILS), 8-4
nondirectional radio beacon
(NDB), 8-4
primary radar, 8-5
responsibility, 8-2
secondary radar, 8-5

very high frequency
omnidirectional range
(VOR)/distance
measuring equipment
(DME)/ tactical air
navigation (TACAN), 8-2

installation

emergency manning, 2-13
introduction, 1-1

M

maintenance, 8-1
ATC certification, 8-7
ground inspection, 8-1
maintenance certification
program, 8-14
equipment list, 8-15
forms, 8-15
records file, 8-14
maintenance standards
air traffic control (ATC), 8-17
airfield advisory, 8-29
airport/airfield lighting
systems, 8-33
application, 8-18
Army ATC towers, 8-22
Army radar approach control
(ARAC), 8-20
ATC mission essential
peculiar items, 8-36
backup power system, 8-19
engineering installation, 8-17
environmental control, 8-39
general, 8-17
ground controlled approach,
8-26
installation facilities, 8-32
instrument landing system
(ILS), 8-25
navigational aid (NAVAID),
8-17
nondirectional beacon, 8-29
operations facility, 8-29
physical security, 8-38
remote communications, 8-
24
terminal VHF omnidirectional
range, 8-27
wind-measuring equipment,
8-31

N

navigational aids
altimeters, 4-13
egress systems, 4-14
night vision devices (NVD),
4-14

O

opening/closing, 2-10
operating initials, 2-8
operating records and forms
ATC facility and personnel
status report, 5-13
ATC maintenance personnel
certification and related
training record, 5-20
contests and appeals, 5-23
daily report, 5-24
flight progress strips, 5-26
GCA operations log, 5-23
operational hazard report, 5-
12
position log, 5-25
records review and
retention, 5-22
tactical approach
publications system, 5-19
training proficiency record,
5-13
other positions for operating
and controlling the ATC
facility, 2-6

P

planning, 1-2
proficiency, 2-8

R

radar
airport surveillance, 3-5
altitude warning, 3-14

automatic acquisition and
termination areas
(installation facilities only),
3-3
automatic program changes
(installation facilities only),
3-3

beacons, 3-15
conflict alert, 3-14
flight inspection approach, 3-
10
mapping, 3-4
safety limits, 3-5
TPX-42/44 system, 3-4
vectoring altitude charts, 3-
12
verification, 3-15

rating, 1-2

record

trainee/controller evaluation,
6-9

records

proficiency, A-1
proficiency—air traffic
controller (ATC), 6-5
proficiency—air traffic
controller (ATC), 7-5
training, A-1
training labels, A-1
training—air traffic controller
(ATC), 7-5
training—air traffic controller
(ATC), 6-5

reference, 5-1

administrative
correspondence, 5-4
charts, Diagrams, and maps,
5-3
controller, 5-2
facility file, 5-2
operating records and forms,
5-12

reference controller files

operating position, 5-2
recent information, 5-2

risk management, F-1

S

shifts, 2-10

T

tactical operations, G-1
flight inspection, G-6
packets, G-8
radar reflector diagram, G-3
terminal instrument
procedures (TERPS), G-1
tape transcriptions, E-1
theodolite operations, D-1
adjusting drums, D-6
flight check commissioning
factors, D-15
preventive maintenance, D-
17
setup, D-2

time, 2-10

training

administration, 6-4, 7-4
management, 6-4, 7-4
manual, 6-4
program of instruction, 6-1,
7-1

training manual, 7-4

training program

installation facility, 6-1
phases, 6-2
tactical facility, 7-1
types, 6-2, 7-2

W

waivers, 1-1

weather, 2-18

watch (installation only), 2-
18

workweeks, 2-10

TRAINING AND PROFICIENCY RECORD - AIR TRAFFIC CONTROLLER

For use of this form, see FM 3-04.303; the proponent agency is TRADOC

GENERAL INFORMATION

This form consists of Sections I through VII. It will be used as an authoritative source of information and reference in regard to the individual's training record as an air traffic controller in the United States Army and as a comprehensive training progress report. The ATC Chief/ATC SR SGT/PSG/facility chief or the training NCO/supervisor shall record the required entries within this form.

SECTION I - PERSONAL IDENTIFYING DATA

NAME <i>(Last, first, middle initial)</i>	ASGD INIT <i>(Pencil)</i>	RANK <i>(Pencil)</i>	CTO NUMBER	ATCS NO.	PMOS	DMOS <i>(Pencil)</i>
---	------------------------------	-------------------------	------------	----------	------	-------------------------

EXPIRATION DATE OF FLIGHT PHYSICAL <i>(Pencil)</i>	EXPIRATION TERM OF SERVICE <i>(Pencil)</i>
--	--

NAME AND LOCATION OF FACILITY TO WHICH ASSIGNED	DUTIES PERFORMED	DATE ASSIGNED		TYPE CERTIFICATES, AWARDS; DATES AND REMARKS
		FROM	TO	

SECTION II - SCHOOLS ATTENDED

NAME OF SCHOOL	LOCATION	DATE COMPLETED

SECTION III - QUALIFICATION, PROFICIENCY, AND REMEDIAL TRAINING RECORD

SUBJECT	TYPE	DATE	HOURS	REMARKS

SECTION IV - WRITTEN/ORAL/PRACTICAL TEST ACTION

SUBJECT	DATE	SCORE	REMARKS

SECTION V - PROFICIENCY CHECKS

POSITION	DATE	SCORE	HOURS	INITIALS		REMARKS
				ATC	SUPV	

SECTION VI - MISCELLANEOUS GENERAL COMMENTS

1

NAME, RANK, AND TITLE

SIGNATURE

2

NAME, RANK, AND TITLE

SIGNATURE

3

NAME, RANK, AND TITLE

SIGNATURE

4

NAME, RANK, AND TITLE

SIGNATURE

5

NAME, RANK, AND TITLE

SIGNATURE

6

NAME, RANK, AND TITLE

SIGNATURE

7

NAME, RANK, AND TITLE

SIGNATURE

SECTION VII - INDIVIDUAL RADAR RECORD

* S/S = Supervised/Simulated

*LV = Live Unsupervised/Non-Simulated

YEAR:	PAR		ASR		EMERG/NO GYRO				GRAND TOTAL	REMARKS
					PAR		ASR			
	*S/S	*LV	*S/S	*LV	*S/S	*LV	*S/S	*LV		
January										
February										
March										
April										
May										
June										
July										
August										
September										
October										
November										
December										
Total Runs for Year										
Total Runs Brought Forward										
TOTAL Runs										

I have verified the runs brought forward are accurate.

FACILITY CHIEF'S PRINTED NAME

FACILITY CHIEF'S SIGNATURE

DATE

TRAINEE/CONTROLLER EVALUATION

For use of this form, see FM 3-04.303; the proponent agency is TRADOC.

NAME	GRADE	ATCS NUMBER	EVALUATION NUMBER		
TYPE OF TRAINING	POSITION/FACILITY EVALUATED		TRAINING MONTH		
EVALUATION FACTOR	EXPECTED PERFORMANCE/REMARKS		SAT	NEEDS IMPROV	UNSAT
A. SEPARATION	1. Separation is ensured.				
	2. Awareness is maintained.				
B. CONTROL JUDGEMENT	3. Good control judgement is applied.				
	4. Control actions are correctly planned.				
	5. Positive control of situations is provided.				
C. TRAFFIC MANAGEMENT	6. Prompt action to correct errors is taken.				
	7. Effective traffic flow is maintained.				
	8. Aircraft identity is maintained.				
	9. Professionalism is maintained.				
D. OPERATING METHODS AND PROCEDURES	10. Flight strip postings are correct and complete.				
	11. Clearance delivery is correct/complete/timely.				
	12. Letters of agreement/directives are adhered to.				
	13. Navigational assistance is provided.				
E. COORDINATION AND COMMUNICATION	14. Weather information is provided.				
	15. Handoff procedures are correctly performed.				
	16. Necessary traffic advisories are provided.				
	17. Coordination is thorough.				
F. PHRASEOLOGY	18. Communication is clear and concise.				
	19. Necessary transmissions are made.				
	20. Standard phraseology is adhered to				
G. EQUIPMENT	21. Voice quality is good.				
	22. Speech rate is correct.				
	23. Equipment capabilities are fully understood/used.				
H. OTHER (Specify)	24.				
	25.				
	26.				
	27.				
TRAFFIC CONDITION (Check one block in each column.)	28.				
	29.				
	<input type="checkbox"/> Light	<input type="checkbox"/> Stable	OVERALL RATING		
	<input type="checkbox"/> Moderate	<input type="checkbox"/> Fluctuating			
<input type="checkbox"/> Heavy					

EVALUATOR COMMENTS		DATE
TYPED/PRINTED NAME AND GRADE		SIGNATURE
CONTROLLER/TRAINEE COMMENTS		DATE
THE UNDERSIGNED <input type="checkbox"/> AGREES <input type="checkbox"/> DISAGREES (If you disagree with the evaluation, refer to specific items of contention in your comments.)		
TYPED/PRINTED NAME AND GRADE		SIGNATURE
REVIEWING AUTHORITY COMMENTS		DATE
TYPED/PRINTED NAME, GRADE, AND TITLE		SIGNATURE

ATC FACILITY AND PERSONNEL STATUS REPORT

For use of this form, see FM 3-04.303; the proponent agency is TRADOC

When this form is filled out, the information will be treated as official use only.
Information contained in this form is covered by Systems Notice A1111.16a.

1. UNIT	2. FACILITY/BRANCH/DIVISION/ELEMENT/SECTION	3. DATE (MONTH/YEAR)
---------	---	----------------------

4. HOURS OF OPERATION

a. TOWER	b. GCA	c. ARAC
d. AIC	e. STAFF	

5. MANNED POSITIONS:	TOWER/NONRADAR APPROACH							AIC/FLT FOL			ARAC/GCA													
SHIFT A (TO)	SL	FD	GC	LC	CD	AP		SL	FD	FF														
SHIFT B (TO)																								
SHIFT C (TO)																								
Sat & Sun SHIFT D (TO)																								

6. TDA AUTHORIZATIONS (BY MOS)	7. TOE AUTHORIZATIONS (BY MOS)
--------------------------------	--------------------------------

8. AIRCRAFT ACTIVITY (BY SHIFT)					9. REMARKS
SHIFT	A	B	C	D	
ARAC					
GCA					
TOWER					
AIC/TOWER FLIGHT FOLLOWING					

11. MONTHLY TRAFFIC RECORD <i>(Installation Facilities Only)</i>				
a. AAF/AHP <i>(Name)</i>				
		MILITARY	AIR CARRIER	GEN AVN
b. TOWER - IFR	(1) LOCAL			
	(2) TRANSIENT			
c. TOWER - VFR	(1) LOCAL			
	(2) TRANSIENT			
d. ARAC <i>(Not to Include Final)</i>	(1) IFR			
	(2) VFR			
e. GCA	RADAR VECTOR <i>(Pattern)</i>			
f. GCA/ARAC	(1) FINAL ASR			
	(2) FINAL PAR			
g. AIC/TOWER FLIGHT FOLLOWING <i>(Total Count)</i>				
12. DATE	13. PREPARED BY <i>(Name and Phone)</i>		14. LAST AIG RECEIVED	
15a. AUTHENTICATION OFFICER <i>(Name, Title, Office Symbol and Phone)</i>			15b. SIGNATURE OF AUTHENTICATION OFFICER	

TAPS

TACTICAL APPROACH PUBLICATIONS SYSTEM

For use of this form, see FM 3-04.303; the proponent agency is TRADOC

- 1 AIRFIELD LOCATION _____
- 2 AIRFIELD ELEVATION _____
- 3 TOWER CALL SIGN/FREQUENCY _____
- 4 NDB FREQUENCY/IDENTIFIER _____
- 5 FINAL APPROACH COURSE _____
- 6 DIRECTION OF TURNS _____
- 7 HIGHEST OBSTACLE HEIGHT _____
- 7A DIRECTION FROM NDB _____
- 7B DISTANCE FROM NDB _____
- 8 MMA _____
- 9 MDA _____
- 10 HAL/VIS _____
- 11 LANDING AREA DIRECTION FROM NDB _____
- 12 LANDING AREA DISTANCE FROM NDB _____
- 13 GCA/CALL SIGN/FREQUENCY _____
- 14 GLIDE PATH ANGLE _____
- 15 FINAL APPROACH _____
- 16 DECISION HEIGHT _____
- 17 HAT/VIS _____
- 18 AIRPORT LIGHTING _____
- 19 MISSED APPROACH POINT _____
- 20 MISSED APPROACH PROCEDURE _____
- 21 AERODROME REMARKS _____

APPROACH PROFILE:

SIGNATURE

DATE

ATC MAINTENANCE PERSONNEL CERTIFICATION AND RELATED TRAINING RECORD

For use of this form, see FM 3-04.303; the proponent agency is TRADOC.

1. NAME (last, first, MI)

2. SSN

3. GRADE/RANK

SECTION I. QUALIFICATION AND CERTIFICATION RECORD

4. SYSTEM/ SUBSYSTEM/ EQUIPMENT	5. THEORY			6. PERFORMANCE			7. CERTIFICATION	
	a. Qual Meth ¹	b. Date Qual	c. Init	a. Qual Meth ¹	b. Date Qual	c. Init	a. Date ₂ Acquired	b. Date Revoked

SECTION III. RELATED TRAINING RECORD AND EXAMINATION RESULTS

12. SYSTEM/ SUBSYSTEM/ EQUIPMENT	13. COURSE NUMBER	14. TRAINING OR EXAMINATION				15. REMARKS	16. INIT
		a.Type ³	b.Number	c.Results ⁴	d.Date Comp		

¹ Enter RTRN for resident training, PEXAM for performance examination, EXP for experience, CEXAM for concepts (theory) examination, PC for prior certification, and NTRN for nonresident training.
² If other than regular certification, enter I for interim.
³ Enter C if action pertains to concepts (theory) or P if action pertains to performance.
⁴ Enter P for passed or F for failed.

RESPONSIBILITY ASSIGNMENT

For use of this form, see FM 3-04.303; the proponent agency is TRADOC.

1. TYPE <input type="checkbox"/> Initial Assignment <input type="checkbox"/> Revision No. _____ <input type="checkbox"/> Revocation	2. DATE	3. PAGE NO.
4. NAME (last, first, MI)	5. LOCATION	
6. POSITION TITLE AND RANK/GRADE	7. IMMEDIATE SUPERVISOR	8. LOCATION/PHONE NO.

NOTE: As recorded on DA Form 3479-9-R, you have demonstrated proficiency on the equipment listed below. You are hereby assigned maintenance and certification responsibility for this equipment. The kinds and levels of responsibility delegated to you are shown by the code designations, which are explained on the reverse side of this form. If you have any questions concerning these assignments or, for example, hours of duty, watch schedules, or crew chiefs, contact your immediate supervisor.

9. SYSTEM/FACILITY/ EQUIPMENT		10. RESPONSIBILITY		11. EFFECTIVE DATES		12. COMMENTS (If none, so state.)
a. Type	b. Ident or Location	a. Maint	b. Cert	a. Start	b. End	

13. SPECIAL INSTRUCTIONS/RESTRICTIONS/LIMITATIONS/REMARKS

14. I understand the nature and extent of the responsibilities listed on this document.
NAME, TITLE, AND GRADE/RANK (typed) AND SIGNATURE OF TECHNICIAN

15. NAME AND TITLE (typed) AND SIGNATURE OF IMMEDIATE SUPERVISOR

16. NAME AND TITLE (typed) AND SIGNATURE OF FACILITY MAINTENANCE CHIEF/35D BN
CERTIFIER

RESPONSIBILITY CODE DESIGNATIONS

MAINTENANCE

CBO Callback only; not regular workload.
FIR Facility inspection responsibility.
R-AST Regular workload assistance as assigned by supervisor.
R-ASTCS Regular workload and/or callback as assigned by supervisor.
RWA Regular workload assignments.
RWCS Regular workload and callback responsibility.
STAF Duties as assigned by the facility maintenance chief such as analytical, diagnostic, evaluation, major modification, inspection, relief, training and supervisory duties.

CERTIFICATION

FC Full certification for complete system.
FIC Full installation certification.
LC Limited certification; subject to listed limitations.
SSC Subsystem certification; limited to listed equipment.

17. COPY TO Technician Maintenance Supervisor Maintenance Chief
 OTHER (Specify) FILE

TACTICAL FACILITY TRAINING PROGRAM (FTP)
AN/TSQ-198 TACTICAL TERMINAL CONTROL SYSTEM

For use of this form, see FM 3-04.303 the proponent agency is TRADOC.

1. NAME	2. RANK	
3. OPERATING INITIALS	4. ATCS NUMBER	
5. SECURITY CLEARANCE	6. FLIGHT PHYSICAL DUE	7. DATE ASSIGNED TO UNIT
8. TRAINING START DATE	9. PHASE I COMPLETE	10. PHASE 2 COMPLETE

11. This is a standardized tactical qualification and rating checklist that will be used to follow the progress of a controller through the training program. All applicable items shall be entered in sections III and IV of DA Form 3479-R.

12. REFERENCES:

- Applicable SOP's
- Appropriate Equipment TM's
- AR 40-8/AR 40-501/AR 95-2
- ARTEP 1-425-MTP
- FAAO 7110.65
- FAAO 8200.1
- FAAO 8260.3
- Flips, Charts and IFR/VFR Supplements
- FM 1-120 (3-04.120)
- FM 3-04.303
- FM 3-52
- FTM

13. The training program consists of two phases: Phase 1 - Qualification, and Phase 2 - Position Training and Rating.

a. Phase 1 consists of individual and team training on the installation, operation and maintenance of all ATS equipment assigned to the Tactical Terminal Control System (*TTCS*). The training program is designed to ensure Phase 1 training is completed within 3 months (*Army National Guard 2 AT's*) of being assigned to the training program. However, as soon as a controller demonstrates proficiency in all applicable areas, phase completion may be achieved at an earlier date.

b. Phase 2 is dependent upon actual mission and the controller's ability to control "LIVE" traffic in a tactical environment. Phase 2 has no set time limit.

14. REMEDIAL TRAINING: Upon completion of phase training or rating, should an individual fail to maintain the required proficiency level, he/she will be placed on Remedial Training. If unable to successfully complete the Remedial Training in time allowed, reclassification actions will be taken.

15. CONTROLLER'S SIGNATURE	16. TACT CHIEF'S SIGNATURE
----------------------------	----------------------------

PHASE 1 - QUALIFICATION

TRAINING STARTED DATE		PHASE 1 RECOMMENDED COMPLETION DATE	
TASK		RECOMMENDED COMPLETION DATE	DATE COMPLETED
1.	Intro to AN/TSQ-198		
2.	FTM Chapter 1		
3.	Operate/PMCS Primary Mover		
4.	Operate/PMCS primary power system		
5.	Install/Operate/PMCS AN/TSQ-198		
6.	SINGARS Operations		
7.	Intro to HAVE QUICK II		
8.	AN/VRC-83 (v) Controls and Indicators		
9.	Single Frequency Operations		
10.	Single Word of Day Operations (<i>SWOD</i>)		
11.	Multiple Word of Day Operations (<i>MWOD</i>)		
12.	MWOD Erase/Freq Management Training		
13.	Program/Operate HF (<i>Normal and ALE</i>)		
14.	Intro to Radio Set Controls (<i>RSC</i>)		
15.	Intro to RSC Menu's		
16.	Program System from RSC		
17.	Remote RSC		
18.	Remote/Install VHF-UHF-AM Ant Group		
19.	Remote/Install VFH-FM Antenna Group		
20.	Remote/Install HF NVIX Antenna		
21.	Prepare AN/TSQ-198 for Operation		
22.	Install Surface Wire Grounding System		
23.	Intro to AN/VRC-83 V3 Radio		
24.	Operator Controls and indicators		
25.	Radio Setup		
26.	Single Channel Programming		

PHASE 1 - QUALIFICATION (Continued)

TRAINING STARTED DATE		PHASE 1 RECOMMENDED COMPLETION DATE	
TASK		RECOMMENDED COMPLETION DATE	DATE COMPLETED
27.	Manual Channel Programming		
28.	Program Frequency for SIMPLEX/HALF DUPLEX Operations		
29.	SINGGAR ECCM Operations		
30.	Utilize Frequency Scan Capabilities		
31.	Perform Radio Checks		
32.	AN/TSQ-198 Emergency Shutdown		
33.	AN/TSQ-198 Alternate Power Sources		
34.	Install/Operate/PMCS Meteorological Measuring System (MMS)		
35.	Prepare AN/TSQ-198 for Deployment		
36.	Install/Operate/PMCS AN/TRN-30 (v) 1 Beacon (Remarks: 15' and 30' Modes)		
37.	Operate COMSEC Equipment		
38.	Operate GPS		
39.	Operate/Maintain NVD		
40.	Determine Landing Direction		
41.	Emplacement of Landing "Y"/NATO "T"		
42.			
43.			
44.			
45.			
46.			
47.			
48.			
49.			
50.			
51.			
52.			

PHASE 2 - POSITION TRAINING AND RATING

TRAINING STARTED DATE		PHASE 2 RECOMMENDED COMPLETION DATE	
TASK		RECOMMENDED COMPLETION DATE	DATE COMPLETED
1.	Phase 2 Initial Weather Certification (<i>USAF</i>)		
2.	Intro to Development of TAPS for NDB		
3.	FTM Chapters 2-4		
4.	FAAO 7110.65 Chapters 2-4		
5.	AR 95-2 Chapters 2-5 and Current AIG Messages		
6.	AR 40-8 and AR 40-501 Chapter 6		
7.	Recognize and Implement ECM and ECCM		
8.	Perform Assumption of Duty Requirements		
9.	Flips, Charts, VFR and IFR Supplements		
10.	Flight Data Procedures		
11.	FTM Chapters 5-8		
12.	A ² C ² (<i>Facility and Mission Specific</i>)		
13.	FTM Chapters 9-12		
14.	FM 3-04.303 Chapters 1 - 3		
15.	FM 3-04.303 Chapters 4, 5, 7		
16.	Flight Data Position Qualification		
17.	Ground Control Procedures		
18.	FAAO 7110.65 Chapters 7 and 10		
19.	Helicopter Landing Zone (<i>HLZ</i>) Operations		
20.	Light Gun Signals		
21.	Provide Emergency Assistance		
22.	Ground Control Position Qualification		
23.	Local Control Procedures		
24.	Provide Traffic Advisories		
25.	Flight Following Procedures		
26.	Local Control Position Qualification		

PHASE 2 - POSITION TRAINING AND RATING (Continued)

TRAINING STARTED DATE	PHASE 2 RECOMMENDED COMPLETION DATE
-----------------------	-------------------------------------

TASK		RECOMMENDED COMPLETION DATE	DATE COMPLETED
27.	Pre-ATCS Exam		
28.	FTM Chapter 13		
29.			
30.			
31.			
32.			
33.			
34.			
35.			
36.			
37.			
38.			
39.			
40.			
41.			
42.			
43.			
44.			
45.			
46.			
47.			
48.			
49.			
50.			

NOTE 1: Those items listed above which do not apply to your unit do not need to be completed. However, as they become relevant, they shall be entered into Section III of DA Form 3479-R.

NOTE 2: The ATCS Examination is required, but it is not annotated in section III as trained.

PHASE 1 - SECTION IV ENTRIES

	TEST	RECOMMENDED COMPLETION DATE	DATE COMPLETED
1.	FTM Chapter 1		
2.	Operate/PMCS primary mover		
3.	Operate/PMCS <i>(primary power system)</i>		
4.	Install/Operate/PMCS AN/TSQ-198 <i>(Includes all equipment training, local and remote, MMS and Sighting Requirements)</i>		
5.	Prepare AN/TSQ-198 for Deployment		
6.	Install/Operate/PMCS AN/TRN-30 (v) 1 Beacon <i>(Remarks: 15' and 30' Modes)</i>		
7.			
8.			
9.			
10.			
11.			
12.			
13.			
14.			
15.			
16.			
17.			
18.			
19.			
20.			
21.			
22.			
23.			
24.			
25.			
26.			
27.			

PHASE 2 - SECTION IV ENTRIES

	TEST	RECOMMENDED COMPLETION DATE	DATE COMPLETED
1.	Initial Weather Certification <i>(USAF)</i>		
2.	HLZ Operations <i>(Includes Landing Direction and Emplacement of Landing "Y" /NATO "T")</i>		
3.	Development of TAPS for NDB		
4.	FTM Chapters 2-4		
5.	FAAO 7110.65 Chapters 2-4		
6.	AR 95-2 Chapters 2-5		
7.	AR 40-8 and AR 40-501		
8.	Flips, Charts, VFR and IFR Supplements		
9.	FTM Chapters 5-8		
10.	FTM Chapters 9 and 12		
11.	FM 3-04.303 Chapters 1-3		
12.	FM 3-04.303 Chapters 4, 5, and 7		
13.	Flight Data Position Qualification		
14.	FAAO 7110.65 Chapters 7 and 10		
15.	Ground Control Position Qualification		
16.	Local Control Position Qualification		
17.	A ² C ² <i>(Facility and Mission Specific)</i>		
18.	Pre-ATCS Exam		
19.	ATCS Exam		
20.	FTM Chapter 13		
21.			
22.			
23.			
24.			
25.			
26.			
27.			

ADDITIONAL ENTRIES

	TEST/TASK	RECOMMENDED COMPLETION DATE	DATE COMPLETED
1.			
2.			
3.			
4.			
5.			
6.			
7.			
8.			
9.			
10.			
11.			
12.			
13.			
14.			
15.			
16.			
17.			
18.			
19.			
20.			
21.			
22.			
23.			

NOTE 1: Those items listed above which do not apply to your unit do not need to be completed. However, as they become relevant, they shall be entered in Section III of DA Form 3479-R.

NOTE 2: Example comments required in Remarks column:

a. Type test given: test without remarks shall be understood as written.

(1) Written, (2) Oral, (3) Practical.

b. Agency administering exam:

(1) Motor Sergeant/Master Driver (*Vehicle Licensing*), (2) USAF (*Weather Exam*)

**TACTICAL FACILITY TRAINING PROGRAM (FTP)
AN/GRC-206 TACTICAL TOWER SYSTEM**

For use of this form, see FM 3-04.303 the proponent agency is TRADOC.

1. NAME		2. RANK	
3. OPERATING INITIALS		4. ATCS NUMBER	
5. SECURITY CLEARANCE		6. FLIGHT PHYSICAL DUE	
		7. DATE ASSIGNED TO UNIT	
8. TRAINING START DATE		9. PHASE I COMPLETE	
		10. PHASE 2 COMPLETE	

11. This is a standardized tactical qualification and rating checklist that will be used to follow the progress of a controller through the training program. All applicable items shall be entered in sections III and IV of DA Form 3479-R.

12. REFERENCES:

- Applicable SOP's
- Appropriate Equipment TM's
- AR 40-8/AR 40-501/AR 95-2
- ARTEP 1-425-MTP
- FAAO 7110.65
- FAAO 8200.1
- FAAO 8260.3
- Flips, Charts and IFR/VFR Supplements
- FM 1-120 (3-04.120)
- FM 3-04.303
- FM 3-52
- FTM

13. The training program consists of two phases: Phase 1 - Qualification, and Phase 2 - Position Training and Rating.

a. Phase 1 consists of individual and team training on the installation, operation and maintenance of all ATS equipment assigned to the Tactical Tower System (*TTCS*). The training program is designed to ensure Phase 1 training is completed within 3 months (*Army National Guard 2 AT's*) of being assigned to the training program. However, as soon as a controller demonstrates proficiency in all applicable areas, phase completion may be achieved at an earlier date.

b. Phase 2 is dependent upon actual mission and the controller's ability to control "LIVE" traffic in a tactical environment. Phase 2 has no set time limit.

14. REMEDIAL TRAINING: Upon completion of phase training or rating, should an individual fail to maintain the required proficiency level, he/she will be placed on Remedial Training. If unable to successfully complete the Remedial Training in time allowed, reclassification actions will be taken.

15. CONTROLLER'S SIGNATURE		16. TACT CHIEF'S SIGNATURE	

PHASE 1 - QUALIFICATION

TRAINING STARTED DATE		PHASE 1 RECOMMENDED COMPLETION DATE	
TASK		RECOMMENDED COMPLETION DATE	DATE COMPLETED
1.	Intro to AN/GRC-206		
2.	FTM Chapter 1		
3.	Operate/PMCS Primary Mover		
4.	Operate/PMCS primary power system		
5.	Install/Operate/PMCS AN/GRC-206		
6.	AN/GRC-206 Emergency shutdown		
7.	AN/GRC-206 Alternate Power Sources		
8.	Disassembly/Storage of AN/GRC-206		
9.	Intro to RSC Menus		
10.	Remote Procedures for RSC		
11.	Install/Operate/PMCS AN/TRN-30(v)1 Beacon <i>(Remarks: 15' and 30' Modes)</i>		
12.	Operate COMSEC Equipment		
13.	Operate GPS		
14.	Operate/Maintain NVD		
15.			
16.			
17.			
18.			
19.			
20.			
21.			
22.			
23.			
24.			
25.			
26.			

PHASE 1 - QUALIFICATION (Continued)

TRAINING STARTED DATE

PHASE 1 RECOMMENDED COMPLETION DATE

	TASK	RECOMMENDED COMPLETION DATE	DATE COMPLETED
27.			
28.			
29.			
30.			
31.			
32.			
33.			
34.			
35.			
36.			
37.			
38.			
39.			
40.			
41.			
42.			
43.			
44.			
45.			
46.			
47.			
48.			
49.			
50.			
51.			
52.			

PHASE 2 - POSITION TRAINING AND RATING

TRAINING STARTED DATE		PHASE 2 RECOMMENDED COMPLETION DATE	
TASK		RECOMMENDED COMPLETION DATE	DATE COMPLETED
1.	Initial weather Certification <i>(USAF)</i>		
2.	Install Landing "Y" / NATO "T"		
3.	AN/GRC-206		
4.	Intro to Development of TAPS for NDB		
5.	FTM Chapters 2-4		
6.	FAAO 7110.65 Chapters 2-4		
7.	AR 95-2 Chapters 2-5 & Current AIG Messages		
8.	AR 40-8 and AR 40-501 Chapter 6		
9.	Recognize and Implement ECM and ECCM		
10.	Perform Assumption of Duty Requirements		
11.	Flips, Charts, VFR and IFR Supplements		
12.	Flight Data Procedures		
13.	FTM Chapters 5-8		
14.	A ² C ² <i>(Facility and Mission Specific)</i>		
15.	FTM Chapters 9 and 12		
16.	FM 3-04.303 Chapters 1-3		
17.	FM 3-04.303 Chapters 4, 5, and 7		
18.	Flight Data Position Qualification		
19.	Ground Control Procedures		
20.	FAAO 7110.65 Chapters 7 and 10		
21.	Provide Emergency Assistance		
22.	HLZ Operations		
23.	Light Gun Procedures		
24.	Ground Control Position Qualification		
25.	Local Control Procedures		
26.	Flight Following Procedures		

PHASE 2 - POSITION TRAINING AND RATING (Continued)

TRAINING STARTED DATE		PHASE 2 RECOMMENDED COMPLETION DATE	
TASK		RECOMMENDED COMPLETION DATE	DATE COMPLETED
27.	Local Control Position Qualification		
28.	Pre-ATCS Exam		
29.	FTM Chapter 13		
30.			
31.			
32.			
33.			
34.			
35.			
36.			
37.			
38.			
39.			
40.			
41.			
42.			
43.			
44.			
45.			
46.			
47.			
48.			
49.			
50.			

NOTE 1: Those items listed above which do not apply to your unit do not need to be completed. However, as they become relevant, they shall be entered into Section III of DA Form 3479-R.

NOTE 2: The ATCS Examination is required, but it is not annotated in section III as trained.

PHASE 1 - SECTION IV ENTRIES

	TEST	RECOMMENDED COMPLETION DATE	DATE COMPLETED
1.	FTM Chapter 1		
2.	Operate/PMCS primary mover		
3.	Operate/PMCS <i>(primary power system)</i>		
4.	Install/Operate/PMCS AN/GRC-206 <i>(Includes all equipment training, local and remote and Sighting Requirements)</i>		
5.	Disassembly/Storage of AN/GRC-206		
6.	Install/Operate/PMCS AN/TRN-30(v)1		
7.	Beacon <i>(Remarks: 15' and 30' Modes)</i>		
8.			
9.			
10.			
11.			
12.			
13.			
14.			
15.			
16.			
17.			
18.			
19.			
20.			
21.			
22.			
23.			
24.			
25.			
26.			
27.			

PHASE 2 - SECTION IV ENTRIES

	TEST	RECOMMENDED COMPLETION DATE	DATE COMPLETED
1.	Initial Weather Certification <i>(USAF)</i>		
2.	HLZ Operations <i>(Includes Landing Direction and Emplacement of Landing "Y" /NATO "T")</i>		
3.	Development of TAPS for NDB		
4.	FTM Chapters 2-4		
5.	FAAO 7110.65 Chapters 2-4		
6.	AR 95-2 Chapters 2-4		
7.	AR 40-8 and AR 40-501		
8.	Flips, Charts, VFR and IFR Supplements		
9.	FTM Chapters 5-8		
10.	FTM Chapters 9 and 12		
11.	FM 3-04.303 Chapters 1-3		
12.	FM 3-04.303 Chapters 4, 5, and 7		
13.	Flight Data Position Qualification		
14.	FAAO 7110.65 Chapters 7 and 10		
15.	Ground Control Position Qualification		
16.	Local Control Position Qualification		
17.	A ² C ² <i>(Facility and Mission Specific)</i>		
18.	Pre-ATCS Exam		
19.	ATCS Exam		
20.	FTM Chapter 13		
21.			
22.			
23.			
24.			
25.			
26.			
27.			

ADDITIONAL ENTRIES

	TEST/TASK	RECOMMENDED COMPLETION DATE	DATE COMPLETED
1.			
2.			
3.			
4.			
5.			
6.			
7.			
8.			
9.			
10.			
11.			
12.			
13.			
14.			
15.			
16.			
17.			
18.			
19.			
20.			
21.			
22.			
23.			

NOTE 1: Those items listed above which do not apply to your unit do not need to be completed. However, as they become relevant, they shall be entered in Section III of DA Form 3479-R.

NOTE 2: Example comments required in Remarks column:

a. Type test given: test without remarks shall be understood as written.

(1) Written, (2) Oral, (3) Practical.

b. Agency administering exam:

(1) Motor Sergeant/Master Driver (*Vehicle Licensing*), (2) USAF (*Weather Exam*)

**TACTICAL FACILITY TRAINING PROGRAM (FTP)
AN/TSC-61B AIRSPACE INFORMATION CENTER**

For use of this form, see FM 3-04.303 the proponent agency is TRADOC.

1. NAME		2. RANK	
3. OPERATING INITIALS		4. ATCS NUMBER	
5. SECURITY CLEARANCE		6. FLIGHT PHYSICAL DUE	7. DATE ASSIGNED TO UNIT
8. TRAINING START DATE		9. PHASE I COMPLETE	10. PHASE 2 COMPLETE

11. This is a standardized tactical qualification and rating checklist that will be used to follow the progress of a controller through the training program. All applicable items shall be entered in sections III and IV of DA Form 3479-R.

12. REFERENCES:

- Applicable SOP's
- Appropriate Equipment TM's
- AR 40-8/AR 40-501/AR 95-2
- ARTEP 1-425-MTP
- FAAO 7110.65
- FAAO 8200.1
- FAAO 8260.3
- Flips, Charts and IFR/VFR Supplements
- FM 1-120 (3-04.120)
- FM 3-04.303
- FM 3-52
- FTM

13. The training program consists of two phases: Phase 1 - Qualification, and Phase 2 - Position Training and Rating.

a. Phase 1 consists of individual and team training on the installation, operation and maintenance of all ATS equipment assigned to the Airspace Information Center. The training program is designed to ensure Phase 1 training is completed within 3 months (*Army National Guard 2 AT's*) of being assigned to the training program. However, as soon as a controller demonstrates proficiency in all applicable areas, phase completion may be achieved at an earlier date.

b. Phase 2 is dependent upon actual mission and the controller's ability to control "LIVE" traffic in a tactical environment. Phase 2 has no set time limit.

14. REMEDIAL TRAINING: Upon completion of phase training or rating, should an individual fail to maintain the required proficiency level, he/she will be placed on Remedial Training. If unable to successfully complete the Remedial Training in time allowed, reclassification actions will be taken.

15. CONTROLLER'S SIGNATURE		16. FACILITY CHIEF'S SIGNATURE	
----------------------------	--	--------------------------------	--

PHASE 1 - QUALIFICATION

TRAINING STARTED DATE		PHASE 1 RECOMMENDED COMPLETION DATE	
	TASK	RECOMMENDED COMPLETION DATE	DATE COMPLETED
1.	Intro to AN/TSC-61B		
2.	FTM Chapter 1		
3.	Operate/PMCS Primary Mover		
4.	Operate/PMCS primary power system		
5.	Install/Operate/PMCS AN/TSC-61B		
6.	AN/TSC-61B Emergency shutdown		
7.	Disassembly/Storage of AN/TSC-61B		
8.	Install/Operate AB-577 Antenna Mast		
9.	Install/Operate/PMCS AN/TRN-30(v)2 Beacon		
10.	Operate COMSEC Equipment		
11.	Operate GPS		
12.			
13.			
14.			
15.			
16.			
17.			
18.			
19.			
20.			
21.			
22.			
23.			
24.			
25.			
26.			

PHASE 1 - QUALIFICATION (Continued)

TRAINING STARTED DATE

PHASE 1 RECOMMENDED COMPLETION DATE

	TASK	RECOMMENDED COMPLETION DATE	DATE COMPLETED
27.			
28.			
29.			
30.			
31.			
32.			
33.			
34.			
35.			
36.			
37.			
38.			
39.			
40.			
41.			
42.			
43.			
44.			
45.			
46.			
47.			
48.			
49.			
50.			
51.			
52.			

PHASE 2 - POSITION TRAINING AND RATING

TRAINING STARTED DATE		PHASE 2 RECOMMENDED COMPLETION DATE	
TASK		RECOMMENDED COMPLETION DATE	DATE COMPLETED
1.	Initial weather Certification <i>(USAF)</i>		
2.	FTM Chapters 2-4		
3.	FAAO 7110.65 Chapters 2-4		
4.	AR 95-2 Chapters 2-5 & Current AIG Messages		
5.	AR 40-8 and AR 40-501 Chapter 6		
6.	Recognize and Implement ECM and ECCM		
7.	Perform Assumption of Duty Requirements		
8.	Flips, Charts, VFR and IFR Supplements		
9.	Flight Data Procedures		
10.	FTM Chapters 5-8		
11.	A ² C ² <i>(Facility and Mission Specific)</i>		
12.	Process Flight Progress Strips		
13.	FTM Chapters 9 and 12		
14.	FM 3-04.303 Chapters 1-3		
15.	FM 3-04.303 Chapters 4, 5, and 7		
16.	Flight Data Position Qualification		
17.	Flight Following Procedures		
18.	Request, Record and Disseminate PIREPS		
19.	FAAO 7110.65 Chapters 7 and 10		
20.	Provide Traffic Advisories		
21.	Flight Following Position Qualification		
22.	Pre-ATCS Exam		
23.	FTM Chapter 13		
24.	Provide Emergency Assistance		
25.			
26.			

PHASE 2 - POSITION TRAINING AND RATING (Continued)

TRAINING STARTED DATE		PHASE 2 RECOMMENDED COMPLETION DATE	
	TASK	RECOMMENDED COMPLETION DATE	DATE COMPLETED
27.			
28.			
29.			
30.			
31.			
32.			
33.			
34.			
35.			
36.			
37.			
38.			
39.			
40.			
41.			
42.			
43.			
44.			
45.			
46.			
47.			
48.			
49.			
50.			

NOTE 1: Those items listed above which do not apply to your unit do not need to be completed. However, as they become relevant, they shall be entered into Section III of DA Form 3479-R.

NOTE 2: The ATCS Examination is required, but it is not annotated in section III as trained.

PHASE 1 - SECTION IV ENTRIES

	TEST	RECOMMENDED COMPLETION DATE	DATE COMPLETED
1.	FTM Chapter 1		
2.	Operate/PMCS primary mover		
3.	Operate/PMCS <i>(primary power system)</i>		
4.	Install/Operate/PMCS AN/TSC-61B <i>(Includes all equipment and Sighting Requirements)</i>		
5.	Disassembly/Storage of AN/TSC-61B		
6.	Install/Operate/PMCS AN/TRN-30(v)2 Beacon		
7.			
8.			
9.			
10.			
11.			
12.			
13.			
14.			
15.			
16.			
17.			
18.			
19.			
20.			
21.			
22.			
23.			
24.			
25.			
26.			
27.			

PHASE 2 - SECTION IV ENTRIES

	TEST	RECOMMENDED COMPLETION DATE	DATE COMPLETED
1.	Initial Weather Certification <i>(USAF)</i>		
2.	FTM Chapters 2-4		
3.	FAAO 7110.65 Chapters 2-4		
4.	AR 95-2 Chapters 2-5		
5.	AR 40-8 and AR 40-501		
6.	Flips, Charts, VFR and IFR Supplements		
7.	FTM Chapters 5-8		
8.	FTM Chapters 9 and 12		
9.	FM 3-04.303 Chapters 1-3		
10.	FM 3-04.303 Chapters 4, 5, and 7		
11.	Flight Data Position Qualification		
12.	FAAO 7110.65 Chapters 7 and 10		
13.	Flight Following Position Qualification		
14.	A ² C ² (Facility and Mission Specific)		
15.	Pre-ATCS Exam		
16.	ATCS Exam		
17.	FTM Chapter 13		
18.			
19.			
20.			
21.			
22.			
23.			
24.			
25.			
26.			
27.			

ADDITIONAL ENTRIES

	TEST/TASK	RECOMMENDED COMPLETION DATE	DATE COMPLETED
1.			
2.			
3.			
4.			
5.			
6.			
7.			
8.			
9.			
10.			
11.			
12.			
13.			
14.			
15.			
16.			
17.			
18.			
19.			
20.			
21.			
22.			
23.			

NOTE 1: Those items listed above which do not apply to your unit do not need to be completed. However, as they become relevant, they shall be entered in Section III of DA Form 3479-R.

NOTE 2: Example comments required in Remarks column:

a. Type test given: test without remarks shall be understood as written.

(1) Written, (2) Oral, (3) Practical.

b. Agency administering exam:

(1) Motor Sergeant/Master Driver (*Vehicle Licensing*), (2) USAF (*Weather Exam*)

TACTICAL FACILITY TRAINING PROGRAM (FTP)
AN/TSQ-221 TACTICAL AIRSPACE INTEGRATION SYSTEM (TAIS)

For use of this form, see FM 3-04.303 the proponent agency is TRADOC.

1. NAME	2. RANK	
3. OPERATING INITIALS	4. ATCS NUMBER	
5. SECURITY CLEARANCE	6. FLIGHT PHYSICAL DUE	7. DATE ASSIGNED TO UNIT
8. TRAINING START DATE	9. PHASE I COMPLETE	10. PHASE 2 COMPLETE

11. This is a standardized tactical qualification and rating checklist that will be used to follow the progress of a controller through the training program. All applicable items shall be entered in sections III and IV of DA Form 3479-R.

12. REFERENCES:

- Applicable SOP's
- Appropriate Equipment TM's
- AR 40-8/AR 40-501/AR 95-2
- ARTEP 1-425-MTP
- FAAO 7110.65
- FAAO 8200.1
- FAAO 8260.3
- Flips, Charts and IFR/VFR Supplements
- FM 1-120 (3-04.120)
- FM 3-04.303
- FM 3-52
- FTM

13. The training program consists of two phases: Phase 1 - Qualification, and Phase 2 - Position Training and Rating.

a. Phase 1 consists of individual and team training on the installation, operation and maintenance of all ATS equipment assigned to the Tactical Airspace Integration System (TAIS). The training program is designed to ensure Phase 1 training is completed within 3 months (*Army National Guard 2 AT's*) of being assigned to the training program. However, as soon as a controller demonstrates proficiency in all applicable areas, phase completion may be achieved at an earlier date.

b. Phase 2 is dependent upon actual mission and the controller's ability to control "LIVE" traffic in a tactical environment. Phase 2 has no set time limit.

14. REMEDIAL TRAINING: Upon completion of phase training or rating, should an individual fail to maintain the required proficiency level, he/she will be placed on Remedial Training. If unable to successfully complete the Remedial Training in time allowed, reclassification actions will be taken.

15. CONTROLLER'S SIGNATURE	16. FACILITY CHIEF'S SIGNATURE
----------------------------	--------------------------------

PHASE 1 - QUALIFICATION

TRAINING STARTED DATE

PHASE 1 RECOMMENDED COMPLETION DATE

TASK		RECOMMENDED COMPLETION DATE	DATE COMPLETED
1.	Intro to AN/TSQ-221		
2.	FTM Chapter 1		
3.	Operate/PMCS Primary Mover		
4.	Operate/PMCS primary power system		
5.	Install/Operate/PMCS AN/TSQ-221		
6.	AN/TSQ-221 Emergency shutdown		
7.	Disassembly/Storage of AN/TSQ-221		
8.	Install Antenna Farm		
9.	Install/Operate/PMCS AN/TRN-30(v)2 Beacon or equivalent		
10.	Operate COMSEC Equipment		
11.	Operate GPS		
12.	Operate Software		
13.	Operate/PMCS Radios		
14.			
15.			
16.			
17.			
18.			
19.			
20.			
21.			
22.			
23.			
24.			
25.			
26.			

PHASE 1 - QUALIFICATION (Continued)

TRAINING STARTED DATE

PHASE 1 RECOMMENDED COMPLETION DATE

	TASK	RECOMMENDED COMPLETION DATE	DATE COMPLETED
27.			
28.			
29.			
30.			
31.			
32.			
33.			
34.			
35.			
36.			
37.			
38.			
39.			
40.			
41.			
42.			
43.			
44.			
45.			
46.			
47.			
48.			
49.			
50.			
51.			
52.			

PHASE 2 - POSITION TRAINING AND RATING

TRAINING STARTED DATE		PHASE 2 RECOMMENDED COMPLETION DATE	
TASK		RECOMMENDED COMPLETION DATE	DATE COMPLETED
1.	Initial weather Certification <i>(USAF)</i>		
2.	Introduction to Airspace Control Order		
3.	Introduction to FM 3-52		
4.	FTM Chapters 2-4		
5.	FAAO 7110.65 Chapters 2-4		
6.	AR 95-2 Chapters 2-5 & Current AIG Messages		
7.	AR 40-8 and AR 40-501 Chapter 6		
8.	Recognize and Implement ECM and ECCM		
9.	Perform Assumption of Duty Requirements		
10.	Flips, Charts, VFR and IFR Supplements		
11.	Flight Data Procedures		
12.	FTM Chapters 5-8		
13.	A ² C ² <i>(Facility and Mission Specific)</i>		
14.	Process Flight Progress Strips		
15.	FTM Chapters 9 and 12		
16.	FM 3-04.303 Chapters 1-3		
17.	FM 3-04.303 Chapters 4, 5, and 7		
18.	Flight Data Position Qualification		
19.	Flight Following Procedures		
20.	Request, Record and Disseminate PIREPS		
21.	FAAO 7110.65 Chapters 7 and 10		
22.	Provide Emergency Assistance		
23.	Provide Traffic Advisories		
24.	Flight Following Position Qualification		
25.	Pre-ATCS Exam		
26.	FTM Chapter 13		

PHASE 2 - POSITION TRAINING AND RATING *(Continued)*

TRAINING STARTED DATE

PHASE 2 RECOMMENDED COMPLETION DATE

	TASK	RECOMMENDED COMPLETION DATE	DATE COMPLETED
27.			
28.			
29.			
30.			
31.			
32.			
33.			
34.			
35.			
36.			
37.			
38.			
39.			
40.			
41.			
42.			
43.			
44.			
45.			
46.			
47.			
48.			
49.			
50.			

NOTE 1: Those items listed above which do not apply to your unit do not need to be completed. However, as they become relevant, they shall be entered into Section III of DA Form 3479-R.

NOTE 2: The ATCS Examination is required, but it is not annotated in section III as trained.

PHASE 1 - SECTION IV ENTRIES

TEST		RECOMMENDED COMPLETION DATE	DATE COMPLETED
1.	FTM Chapter 1		
2.	Operate/PMCS primary mover		
3.	Operate/PMCS <i>(primary power system)</i>		
4.	Install/Operate/PMCS AN/TSQ-221 <i>(Includes all equipment training and Sighting Requirements)</i>		
5.	Disassembly/Storage of AN/TSQ-221		
6.	Install/Operate/PMCS AN/TRN-30(v)2 Beacon		
7.			
8.			
9.			
10.			
11.			
12.			
13.			
14.			
15.			
16.			
17.			
18.			
19.			
20.			
21.			
22.			
23.			
24.			
25.			
26.			
27.			

PHASE 2 - SECTION IV ENTRIES

	TEST	RECOMMENDED COMPLETION DATE	DATE COMPLETED
1.	Initial Weather Certification <i>(USAF)</i>		
2.	FTM Chapters 2-4		
3.	FAAO 7110.65 Chapters 2-4		
4.	AR 95-2 Chapters 2-5		
5.	AR 40-8 and AR 40-501		
6.	Flips, Charts, VFR and IFR Supplements		
7.	FTM Chapters 5-8		
8.	FTM Chapters 9 and 12		
9.	FM 3-04.303 Chapters 1-3		
10.	FM 3-04.303 Chapters 4, 5, and 7		
11.	Flight Data Position Qualification		
12.	FAAO 7110.65 Chapters 7 and 10		
13.	Flight Following Position Qualification		
14.	Pre-ATCS Exam		
15.	ATCS Exam		
16.	FTM Chapter 13		
17.			
18.			
19.			
20.			
21.			
22.			
23.			
24.			
25.			
26.			
27.			

ADDITIONAL ENTRIES

	TEST/TASK	RECOMMENDED COMPLETION DATE	DATE COMPLETED
1.			
2.			
3.			
4.			
5.			
6.			
7.			
8.			
9.			
10.			
11.			
12.			
13.			
14.			
15.			
16.			
17.			
18.			
19.			
20.			
21.			
22.			
23.			

NOTE 1: Those items listed above which do not apply to your unit do not need to be completed. However, as they become relevant, they shall be entered in Section III of DA Form 3479-R.

NOTE 2: Example comments required in Remarks column:

a. Type test given: test without remarks shall be understood as written.

(1) Written, (2) Oral, (3) Practical.

b. Agency administering exam:

(1) Motor Sergeant/Master Driver (*Vehicle Licensing*), (2) USAF (*Weather Exam*)

**TACTICAL FACILITY TRAINING PROGRAM (FTP)
AN/TSW-7A AIR TRAFFIC CONTROL CENTRAL**

For use of this form, see FM 3-04.303 the proponent agency is TRADOC.

1. NAME	2. RANK	
3. OPERATING INITIALS	4. ATCS NUMBER	
5. SECURITY CLEARANCE	6. FLIGHT PHYSICAL DUE	7. DATE ASSIGNED TO UNIT
8. TRAINING START DATE	9. PHASE I COMPLETE	10. PHASE 2 COMPLETE

11. This is a standardized tactical qualification and rating checklist that will be used to follow the progress of a controller through the training program. All applicable items shall be entered in sections III and IV of DA Form 3479-R.

12. REFERENCES:

- Applicable SOP's
- Appropriate Equipment TM's
- AR 40-8/AR 40-501/AR 95-2
- ARTEP 1-425-MTP
- FAAO 7110.65
- FAAO 8200.1
- FAAO 8260.3
- Flips, Charts and IFR/VFR Supplements
- FM 1-120 (3-04.120)
- FM 3-04.303
- FM 3-52
- FTM

13. The training program consists of two phases: Phase 1 - Qualification, and Phase 2 - Position Training and Rating.

a. Phase 1 consists of individual and team training on the installation, operation and maintenance of all ATS equipment assigned to the Tactical Tower Section. The training program is designed to ensure Phase 1 training is completed within 3 months (*Army National Guard 2 AT's*) of being assigned to the training program. However, as soon as a controller demonstrates proficiency in all applicable areas, phase completion may be achieved at an earlier date.

b. Phase 2 is dependent upon actual mission and the controller's ability to control "LIVE" traffic in a tactical environment. Phase 2 has no set time limit.

14. REMEDIAL TRAINING: Upon completion of phase training or rating, should an individual fail to maintain the required proficiency level, he/she will be placed on Remedial Training. If unable to successfully complete the Remedial Training in time allowed, reclassification actions will be taken.

15. CONTROLLER'S SIGNATURE	16. FACILITY CHIEF'S SIGNATURE
----------------------------	--------------------------------

PHASE 1 - QUALIFICATION

TRAINING STARTED DATE

PHASE 1 RECOMMENDED COMPLETION DATE

TASK		RECOMMENDED COMPLETION DATE	DATE COMPLETED
1.	Intro to AN/TSW-7A		
2.	FTM Chapter 1		
3.	Operate/PMCS Primary Mover		
4.	Operate/PMCS primary power system		
5.	Install/Operate/PMCS AN/TSW-7A		
6.	Disassembly/Storage of AN/TSW-7A		
7.	Install/Operate/PMCS ECUs		
8.	Install/Operate/PMCS AN/TRN-30(v)1 Beacon <i>(Remarks: 15' & 30' Modes)</i>		
9.	Operate COMSEC Equipment		
10.	Operate GPS		
11.	Operate/Maintain NVD		
12.	Install Landing "Y" / NATO "T"		
13.			
14.			
15.			
16.			
17.			
18.			
19.			
20.			
21.			
22.			
23.			
24.			
25.			
26.			

PHASE 1 - QUALIFICATION (Continued)

TRAINING STARTED DATE

PHASE 1 RECOMMENDED COMPLETION DATE

	TASK	RECOMMENDED COMPLETION DATE	DATE COMPLETED
27.			
28.			
29.			
30.			
31.			
32.			
33.			
34.			
35.			
36.			
37.			
38.			
39.			
40.			
41.			
42.			
43.			
44.			
45.			
46.			
47.			
48.			
49.			
50.			
51.			
52.			

PHASE 2 - POSITION TRAINING AND RATING

TRAINING STARTED DATE		PHASE 2 RECOMMENDED COMPLETION DATE	
TASK		RECOMMENDED COMPLETION DATE	DATE COMPLETED
1.	Initial weather Certification <i>(USAF)</i>		
2.	Intro to Development of TAPS for NDB		
3.	FTM Chapters 2-4		
4.	FAAO 7110.65 Chapters 2-4		
5.	AR 95-2 Chapters 2-5 & Current AIG Messages		
6.	AR 40-8 and AR 40-501 Chapter 6		
7.	Recognize and Implement ECM & ECCM		
8.	Perform Assumption of Duty Requirements		
9.	Flips, Charts, VFR and IFR Supplements		
10.	Flight Data Procedures		
11.	FTM Chapters 5-8		
12.	A ² C ² <i>(Facility and Mission Specific)</i>		
13.	Process Flight Progress Strips		
14.	FTM Chapters 9 and 12		
15.	FM 3-04.303 Chapters 1-3		
16.	FM 3-04.303 Chapters 4, 5, and 7		
17.	Flight Data Position Qualification		
18.	Ground Control Procedures		
19.	FAAO 7110.65 Chapters 7 and 10		
20.	Provide Emergency Assistance		
21.	Light Gun Procedures		
22.	Ground Control Position Qualification		
23.	Local Control Procedures		
24.	Flight Following Procedures		
25.	Local Control Position Qualification		
26.	Pre-ATCS Exam		
27.	FTM Chapter 13		

PHASE 2 - POSITION TRAINING AND RATING (Continued)

TRAINING STARTED DATE	PHASE 2 RECOMMENDED COMPLETION DATE
-----------------------	-------------------------------------

TASK	RECOMMENDED COMPLETION DATE	DATE COMPLETED
27.		
28.		
29.		
30.		
31.		
32.		
33.		
34.		
35.		
36.		
37.		
38.		
39.		
40.		
41.		
42.		
43.		
44.		
45.		
46.		
47.		
48.		
49.		
50.		

NOTE 1: Those items listed above which do not apply to your unit do not need to be completed. However, as they become relevant, they shall be entered into Section III of DA Form 3479-R.

NOTE 2: The ATCS Examination is required, but it is not annotated in section III as trained.

PHASE 1 - SECTION IV ENTRIES

TEST		RECOMMENDED COMPLETION DATE	DATE COMPLETED
1.	FTM Chapter 1		
2.	Operate/PMCS primary mover		
3.	Operate/PMCS <i>(primary power system)</i>		
4.	Install/Operate/PMCS AN/TSW-7A <i>(Includes all equipment training and Sighting Requirements)</i>		
5.	Disassembly/Storage of AN/TSW-7A		
6.	Install/Operate/PMCS AN/TRN-30(v)1 Beacon <i>(Remarks: 15' and 30' Modes)</i>		
7.	Develop Airfield Setup <i>(Includes Determine Landing Direction and Emplacement of Landing "Y" / NATO "T")</i>		
8.			
9.			
10.			
11.			
12.			
13.			
14.			
15.			
16.			
17.			
18.			
19.			
20.			
21.			
22.			
23.			
24.			
25.			
26.			
27.			

PHASE 2 - SECTION IV ENTRIES

	TEST	RECOMMENDED COMPLETION DATE	DATE COMPLETED
1.	Initial Weather Certification <i>(USAF)</i>		
2.	Development of TAPS for NDB		
3.	FTM Chapters 2-4		
4.	FAAO 7110.65 Chapters 2-4		
5.	AR 95-2 Chapters 2-5		
6.	AR 40-8 and AR 40-501 Chapter 6		
7.	A ² C ² <i>(Facility and Mission Specific)</i>		
8.	Flips, Charts, VFR and IFR Supplements		
9.	FTM Chapters 5-8		
10.	FTM Chapters 9 and 12		
11.	FM 3-04.303 Chapters 1-3		
12.	FM 3-04.303 Chapters 4, 5, and 7		
13.	Flight Data Position Qualification		
14.	FAAO 7110.65 Chapters 7 and 10		
15.	Ground Control Position Qualification		
16.	Local Control Position Qualification		
17.	Pre-ATCS Exam		
18.	ATCS Exam		
19.	FTM Chapter 13		
20.			
21.			
22.			
23.			
24.			
25.			
26.			
27.			

**TACTICAL FACILITY TRAINING PROGRAM (FTP)
AN/TSQ-71B LANDING CONTROL CENTRAL**

For use of this form, see FM 3-04.303 the proponent agency is TRADOC.

1. NAME		2. RANK	
3. OPERATING INITIALS		4. ATCS NUMBER	
5. SECURITY CLEARANCE		6. FLIGHT PHYSICAL DUE	
		7. DATE ASSIGNED TO UNIT	
8. TRAINING START DATE		9. PHASE I COMPLETE	
		10. PHASE 2 COMPLETE	

11. This is a standardized tactical qualification and rating checklist that will be used to follow the progress of a controller through the training program. All applicable items shall be entered in sections III and IV of DA Form 3479-R.

12. REFERENCES:

- Applicable SOP's
- Appropriate Equipment TM's
- AR 40-8/AR 40-501/AR 95-2
- ARTEP 1-425-MTP
- FAAO 7110.65
- FAAO 8200.1
- FAAO 8260.3
- Flips, Charts and IFR/VFR Supplements
- FM 1-120 (3-04.120)
- FM 3-04.303
- FM 3-52
- FTM

13. The training program consists of two phases: Phase 1 - Qualification, and Phase 2 - Position Training and Rating.

a. Phase 1 consists of individual and team training on the installation, operation and maintenance of all ATS equipment assigned to the Tactical Ground Control Approach (GCA). The training program is designed to ensure Phase 1 training is completed within 3 months (*Army National Guard 2 AT's*) of being assigned to the training program. However, as soon as a controller demonstrates proficiency in all applicable areas, phase completion may be achieved at an earlier date.

b. Phase 2 is dependent upon actual mission and the controller's ability to control "LIVE" traffic in a tactical environment. Phase 2 has no set time limit.

14. REMEDIAL TRAINING: Upon completion of phase training or rating, should an individual fail to maintain the required proficiency level, he/she will be placed on Remedial Training. If unable to successfully complete the Remedial Training in time allowed, reclassification actions will be taken.

15. CONTROLLER'S SIGNATURE		16. FACILITY CHIEF'S SIGNATURE	

PHASE 1 - QUALIFICATION

TRAINING STARTED DATE		PHASE 1 RECOMMENDED COMPLETION DATE	
TASK		RECOMMENDED COMPLETION DATE	DATE COMPLETED
1.	Intro to AN/TSQ-71B		
2.	FTM Chapter1		
3.	Operate/PMCS Primary Mover		
4.	Operate/PMCS primary power system		
5.	Install/Operate/PMCS PU-126		
6.	Install/Operate/PMCS AN/TSQ-71B		
7.	Emergency Shutdown Procedures		
8.	Disassembly/Storage of AN/TSQ-71B		
9.	Radiation Hazard Briefing		
10.	Install/Operate/PMCS AN/TPX-44(IFF)		
11.	Disassembly/Storage of AN/TPX-44		
12.	Operate COMSEC Equipment		
13.	Operate GPS		
14.	Site and Shelter Requirements		
15.	Develop Airfield Layout <i>(Includes Reflector Emplacement Methods Develop Reflector layout Diagram)</i>		
16.	Determine Ground Angle		
17.	Determine Dial Divisions		
18.	Perform ASR/PAR Cursor Alignments		
19.	Install/Operate Theodolite		
20.			
21.			
22.			
23.			
24.			
25.			
26.			

PHASE 1 - QUALIFICATION (Continued)

TRAINING STARTED DATE

PHASE 1 RECOMMENDED COMPLETION DATE

	TASK	RECOMMENDED COMPLETION DATE	DATE COMPLETED
27.			
28.			
29.			
30.			
31.			
32.			
33.			
34.			
35.			
36.			
37.			
38.			
39.			
40.			
41.			
42.			
43.			
44.			
45.			
46.			
47.			
48.			
49.			
50.			
51.			
52.			

PHASE 2 - POSITION TRAINING AND RATING

TRAINING STARTED DATE		PHASE 2 RECOMMENDED COMPLETION DATE	
TASK		RECOMMENDED COMPLETION DATE	DATE COMPLETED
1.	Initial Weather Certification		
2.	Intro to Development of Instrument Approach Procedures (<i>TERPS</i>)		
3.	Develop MVA Chart		
4.	Recognize and Implement ECM & ECCM		
5.	FTM Chapters 2-4		
6.	FAAO 7110.65 Chapters 2 and 3		
7.	AR 95-2 Chapters 2-5 & Current AIG Messages		
8.	R 40-8 and AR 40-501 Chapter 6		
9.	A ² C ² (<i>Facility and Mission Specific</i>)		
10.	Flips, Charts, VFR and IFR Supplements		
11.	FM 3-04.303 Chapters 1-3		
12.	FM 3-04.303 Chapters 4, 5, and 7		
13.	Perform Assumption of Duty Requirements		
14.	Flight Data Procedures		
15.	Provide Emergency Assistance		
16.	Flight Check Procedures		
17.	FTM Chapters 5-8		
18.	Flight Data Position Qualification		
19.	FTM Chapters 9 and 12		
20.	FAAO 7110.65 Chapters 5		
21.	FAAO 7110.65 Chapters 7 and 10		
22.	ASR/PAR Procedures		
23.	PAR Lower Safety Limits		
24.	Operations in Simultaneous Mode		
25.	ASR/PAR Position Qualification		
26.	Pre-ATCS Exam		
27.	FTM Chapter 13		

PHASE 2 - POSITION TRAINING AND RATING *(Continued)*

TRAINING STARTED DATE

PHASE 2 RECOMMENDED COMPLETION DATE

	TASK	RECOMMENDED COMPLETION DATE	DATE COMPLETED
27.			
28.			
29.			
30.			
31.			
32.			
33.			
34.			
35.			
36.			
37.			
38.			
39.			
40.			
41.			
42.			
43.			
44.			
45.			
46.			
47.			
48.			
49.			
50.			

NOTE 1: Those items listed above which do not apply to your unit do not need to be completed. However, as they become relevant, they shall be entered into Section III of DA Form 3479-R.

NOTE 2: The ATCS Examination is required, but it is not annotated in section III as trained.

PHASE 1 - SECTION IV ENTRIES

TEST		RECOMMENDED COMPLETION DATE	DATE COMPLETED
1.	FTM Chapter 1		
2.	Operate/PMCS primary mover		
3.	Operate/PMCS <i>(primary power system)</i>		
4.	Install/Operate/PMCS AN/TSQ-71B System <i>(Includes 71B, TPN-18A, TPX-44 w/power and Site and Shelter Requirements)</i>		
5.	Disassembly/Storage of AN/TSQ-71B		
6.	<i>Airfield Layout (Includes Reflector Emplacement Methods, Develop Reflector Layout Diagram, Determine Ground Angle, Determine Dial Divisions and Install/Operate Theodolite)</i>		
7.			
8.			
9.			
10.			
11.			
12.			
13.			
14.			
15.			
16.			
17.			
18.			
19.			
20.			
21.			
22.			
23.			
24.			
25.			
26.			

PHASE 2 - SECTION IV ENTRIES

	TEST	RECOMMENDED COMPLETION DATE	DATE COMPLETED
1.	Initial Weather Certification		
2.	Intro to TERPS (<i>Includes Develop Instrument Approach Procedures and Develop MVA Chart</i>)		
3.	FTM Chapters 2-4		
4.	FAAO 7110.65 Chapters 2 and 3		
5.	AR 95-2		
6.	AR 40-8 and AR 40-501		
7.	Flips, Charts, VFR and IFR Supplements		
8.	FM 3-04.303 Chapters 1-3		
9.	FM 3-04.303 Chapters 4, 5, and 7		
10.	FTM Chapters 5-8		
11.	Flight Data Position Qualification Exam		
12.	FTM Chapters 9 and 12		
13.	FAAO 7110.65 Chapters 5		
14.	FAAO 7110.65 Chapters 7 and 10		
15.	ASR/PAR Position Qualification		
16.	A ² C ² (<i>Facility and Mission Specific</i>)		
17.	Pre-ATCS Exam		
18.	ATCS Exam		
19.	FTM Chapter 13		
20.			
21.			
22.			
23.			
24.			
25.			
26.			
27.			

ADDITIONAL ENTRIES

	TEST/TASK	RECOMMENDED COMPLETION DATE	DATE COMPLETED
1.			
2.			
3.			
4.			
5.			
6.			
7.			
8.			
9.			
10.			
11.			
12.			
13.			
14.			
15.			
16.			
17.			
18.			
19.			
20.			
21.			
22.			
23.			

NOTE 1: Those items listed above which do not apply to your unit do not need to be completed. However, as they become relevant, they shall be entered in Section III of DA Form 3479-R.

NOTE 2: Example comments required in Remarks column:

a. Type test given: test without remarks shall be understood as written.

(1) Written, (2) Oral, (3) Practical.

b. Agency administering exam:

(1) Motor Sergeant/Master Driver (*Vehicle Licensing*), (2) USAF (*Weather Exam*)

ADDITIONAL ENTRIES

	TEST/TASK	RECOMMENDED COMPLETION DATE	DATE COMPLETED
1.			
2.			
3.			
4.			
5.			
6.			
7.			
8.			
9.			
10.			
11.			
12.			
13.			
14.			
15.			
16.			
17.			
18.			
19.			
20.			
21.			
22.			
23.			

NOTE 1: Those items listed above which do not apply to your unit do not need to be completed. However, as they become relevant, they shall be entered in Section III of DA Form 3479-R.

NOTE 2: Example comments required in Remarks column:

a. Type test given: test without remarks shall be understood as written.

(1) Written, (2) Oral, (3) Practical.

b. Agency administering exam:

(1) Motor Sergeant/Master Driver (*Vehicle Licensing*), (2) USAF (*Weather Exam*)

**TACTICAL FACILITY TRAINING PROGRAM (FTP)
AN/TSQ-71B LANDING CONTROL CENTRAL**

For use of this form, see FM 3-04.303 the proponent agency is TRADOC.

1. NAME		2. RANK			
3. OPERATING INITIALS		4. ATCS NUMBER			
5. SECURITY CLEARANCE		6. FLIGHT PHYSICAL DUE		7. DATE ASSIGNED TO UNIT	
8. TRAINING START DATE		9. PHASE I COMPLETE		10. PHASE 2 COMPLETE	

11. This is a standardized tactical qualification and rating checklist that will be used to follow the progress of a controller through the training program. All applicable items shall be entered in sections III and IV of DA Form 3479-R.

12. REFERENCES:

- Applicable SOP's
- Appropriate Equipment TM's
- AR 40-8/AR 40-501/AR 95-2
- ARTEP 1-425-MTP
- FAAO 7110.65
- FAAO 8200.1
- FAAO 8260.3
- Flips, Charts and IFR/VFR Supplements
- FM 1-120 (3-04.120)
- FM 3-04.303
- FM 3-52
- FTM

13. The training program consists of two phases: Phase 1 - Qualification, and Phase 2 - Position Training and Rating.

a. Phase 1 consists of individual and team training on the installation, operation and maintenance of all ATS equipment assigned to the Tactical Ground Control Approach (GCA). The training program is designed to ensure Phase 1 training is completed within 3 months (*Army National Guard 2 AT's*) of being assigned to the training program. However, as soon as a controller demonstrates proficiency in all applicable areas, phase completion may be achieved at an earlier date.

b. Phase 2 is dependent upon actual mission and the controller's ability to control "LIVE" traffic in a tactical environment. Phase 2 has no set time limit.

14. REMEDIAL TRAINING: Upon completion of phase training or rating, should an individual fail to maintain the required proficiency level, he/she will be placed on Remedial Training. If unable to successfully complete the Remedial Training in time allowed, reclassification actions will be taken.

15. CONTROLLER'S SIGNATURE		16. FACILITY CHIEF'S SIGNATURE	
----------------------------	--	--------------------------------	--

PHASE 1 - QUALIFICATION

TRAINING STARTED DATE		PHASE 1 RECOMMENDED COMPLETION DATE	
TASK		RECOMMENDED COMPLETION DATE	DATE COMPLETED
1.	Intro to AN/TSQ-71B		
2.	FTM Chapter1		
3.	Operate/PMCS Primary Mover		
4.	Operate/PMCS primary power system		
5.	Install/Operate/PMCS PU-126		
6.	Install/Operate/PMCS AN/TSQ-71B		
7.	Emergency Shutdown Procedures		
8.	Disassembly/Storage of AN/TSQ-71B		
9.	Radiation Hazard Briefing		
10.	Install/Operate/PMCS AN/TPX-44(IFF)		
11.	Disassembly/Storage of AN/TPX-44		
12.	Operate COMSEC Equipment		
13.	Operate GPS		
14.	Site and Shelter Requirements		
15.	Develop Airfield Layout <i>(Includes Reflector Emplacement Methods Develop Reflector layout Diagram)</i>		
16.	Determine Ground Angle		
17.	Determine Dial Divisions		
18.	Perform ASR/PAR Cursor Alignments		
19.	Install/Operate Theodolite		
20.			
21.			
22.			
23.			
24.			
25.			
26.			

PHASE 1 - QUALIFICATION (Continued)

TRAINING STARTED DATE

PHASE 1 RECOMMENDED COMPLETION DATE

	TASK	RECOMMENDED COMPLETION DATE	DATE COMPLETED
27.			
28.			
29.			
30.			
31.			
32.			
33.			
34.			
35.			
36.			
37.			
38.			
39.			
40.			
41.			
42.			
43.			
44.			
45.			
46.			
47.			
48.			
49.			
50.			
51.			
52.			

PHASE 2 - POSITION TRAINING AND RATING

TRAINING STARTED DATE		PHASE 2 RECOMMENDED COMPLETION DATE	
TASK		RECOMMENDED COMPLETION DATE	DATE COMPLETED
1.	Initial Weather Certification		
2.	Intro to Development of Instrument Approach Procedures (<i>TERPS</i>)		
3.	Develop MVA Chart		
4.	Recognize and Implement ECM & ECCM		
5.	FTM Chapters 2-4		
6.	FAAO 7110.65 Chapters 2 and 3		
7.	AR 95-2 Chapters 2-5 & Current AIG Messages		
8.	R 40-8 and AR 40-501 Chapter 6		
9.	A ² C ² (<i>Facility and Mission Specific</i>)		
10.	Flips, Charts, VFR and IFR Supplements		
11.	FM 3-04.303 Chapters 1-3		
12.	FM 3-04.303 Chapters 4, 5, and 7		
13.	Perform Assumption of Duty Requirements		
14.	Flight Data Procedures		
15.	Provide Emergency Assistance		
16.	Flight Check Procedures		
17.	FTM Chapters 5-8		
18.	Flight Data Position Qualification		
19.	FTM Chapters 9 and 12		
20.	FAAO 7110.65 Chapters 5		
21.	FAAO 7110.65 Chapters 7 and 10		
22.	ASR/PAR Procedures		
23.	PAR Lower Safety Limits		
24.	Operations in Simultaneous Mode		
25.	ASR/PAR Position Qualification		
26.	Pre-ATCS Exam		
27.	FTM Chapter 13		

PHASE 2 - POSITION TRAINING AND RATING *(Continued)*

TRAINING STARTED DATE

PHASE 2 RECOMMENDED COMPLETION DATE

	TASK	RECOMMENDED COMPLETION DATE	DATE COMPLETED
27.			
28.			
29.			
30.			
31.			
32.			
33.			
34.			
35.			
36.			
37.			
38.			
39.			
40.			
41.			
42.			
43.			
44.			
45.			
46.			
47.			
48.			
49.			
50.			

NOTE 1: Those items listed above which do not apply to your unit do not need to be completed. However, as they become relevant, they shall be entered into Section III of DA Form 3479-R.

NOTE 2: The ATCS Examination is required, but it is not annotated in section III as trained.

PHASE 1 - SECTION IV ENTRIES

TEST		RECOMMENDED COMPLETION DATE	DATE COMPLETED
1.	FTM Chapter 1		
2.	Operate/PMCS primary mover		
3.	Operate/PMCS <i>(primary power system)</i>		
4.	Install/Operate/PMCS AN/TSQ-71B System <i>(Includes 71B, TPN-18A, TPX-44 w/power and Site and Shelter Requirements)</i>		
5.	Disassembly/Storage of AN/TSQ-71B		
6.	<i>Airfield Layout (Includes Reflector Emplacement Methods, Develop Reflector Layout Diagram, Determine Ground Angle, Determine Dial Divisions and Install/Operate Theodolite)</i>		
7.			
8.			
9.			
10.			
11.			
12.			
13.			
14.			
15.			
16.			
17.			
18.			
19.			
20.			
21.			
22.			
23.			
24.			
25.			
26.			

PHASE 2 - SECTION IV ENTRIES

	TEST	RECOMMENDED COMPLETION DATE	DATE COMPLETED
1.	Initial Weather Certification		
2.	Intro to TERPS (<i>Includes Develop Instrument Approach Procedures and Develop MVA Chart</i>)		
3.	FTM Chapters 2-4		
4.	FAAO 7110.65 Chapters 2 and 3		
5.	AR 95-2		
6.	AR 40-8 and AR 40-501		
7.	Flips, Charts, VFR and IFR Supplements		
8.	FM 3-04.303 Chapters 1-3		
9.	FM 3-04.303 Chapters 4, 5, and 7		
10.	FTM Chapters 5-8		
11.	Flight Data Position Qualification Exam		
12.	FTM Chapters 9 and 12		
13.	FAAO 7110.65 Chapters 5		
14.	FAAO 7110.65 Chapters 7 and 10		
15.	ASR/PAR Position Qualification		
16.	A ² C ² (<i>Facility and Mission Specific</i>)		
17.	Pre-ATCS Exam		
18.	ATCS Exam		
19.	FTM Chapter 13		
20.			
21.			
22.			
23.			
24.			
25.			
26.			
27.			

ADDITIONAL ENTRIES

	TEST/TASK	RECOMMENDED COMPLETION DATE	DATE COMPLETED
1.			
2.			
3.			
4.			
5.			
6.			
7.			
8.			
9.			
10.			
11.			
12.			
13.			
14.			
15.			
16.			
17.			
18.			
19.			
20.			
21.			
22.			
23.			

NOTE 1: Those items listed above which do not apply to your unit do not need to be completed. However, as they become relevant, they shall be entered in Section III of DA Form 3479-R.

NOTE 2: Example comments required in Remarks column:

a. Type test given: test without remarks shall be understood as written.

(1) Written, (2) Oral, (3) Practical.

b. Agency administering exam:

(1) Motor Sergeant/Master Driver (*Vehicle Licensing*), (2) USAF (*Weather Exam*)

TACTICAL FACILITY TRAINING PROGRAM (FTP)
AN/TPN-31 AIR TRAFFIC NAVIGATION INTEGRATION AND COORDINATION SYSTEM (ATNAVICS)

For use of this form, see FM 3-04.303 the proponent agency is TRADOC.

1. NAME	2. RANK	
3. OPERATING INITIALS	4. ATCS NUMBER	
5. SECURITY CLEARANCE	6. FLIGHT PHYSICAL DUE	7. DATE ASSIGNED TO UNIT
8. TRAINING START DATE	9. PHASE I COMPLETE	10. PHASE 2 COMPLETE

11. This is a standardized tactical qualification and rating checklist that will be used to follow the progress of a controller through the training program. All applicable items shall be entered in sections III and IV of DA Form 3479-R.

12. REFERENCES:

- Applicable SOP's
- Appropriate Equipment TM's
- AR 40-8/AR 40-501/AR 95-2
- ARTEP 1-425-MTP
- FAAO 7110.65
- FAAO 8200.1
- FAAO 8260.3
- Flips, Charts and IFR/VFR Supplements
- FM 1-120 (3-04.120)
- FM 3-04.303
- FM 3-52
- FTM

13. The training program consists of two phases: Phase 1 - Qualification, and Phase 2 - Position Training and Rating.

a. Phase 1 consists of individual and team training on the installation, operation and maintenance of all ATS equipment assigned to the Tactical Ground Control Approach (GCA). The training program is designed to ensure Phase 1 training is completed within 3 months (*Army National Guard 2 AT's*) of being assigned to the training program. However, as soon as a controller demonstrates proficiency in all applicable areas, phase completion may be achieved at an earlier date.

b. Phase 2 is dependent upon actual mission and the controller's ability to control "LIVE" traffic in a tactical environment. Phase 2 has no set time limit.

14. REMEDIAL TRAINING: Upon completion of phase training or rating, should an individual fail to maintain the required proficiency level, he/she will be placed on Remedial Training. If unable to successfully complete the Remedial Training in time allowed, reclassification actions will be taken.

15. CONTROLLER'S SIGNATURE	16. FACILITY CHIEF'S SIGNATURE
----------------------------	--------------------------------

PHASE 1 - QUALIFICATION

TRAINING STARTED DATE		PHASE 1 RECOMMENDED COMPLETION DATE	
TASK		RECOMMENDED COMPLETION DATE	DATE COMPLETED
1.	Intro to AN/TPN-31 (ATNAVICS)		
2.	FTM Chapter 1		
3.	Operate/PMCS Primary Mover		
4.	Operate/PMCS power system		
5.	Operate/PMCS Trailer		
6.	Operate/PMCS Satellite Navigation Set GPS		
7.	Operate PMCS Theodolite		
8.	Operate PMCS Communications Equipment		
9.	Collect Pre-deployment Survey Data		
10.	Install/Operate/PMCS AN/TPN-31		
11.	AN/TPN-31 Emergency shutdown		
12.	Disassembly/Storage of AN/TPN-31		
13.	Operate COMSEC Equipment		
14.			
15.			
16.			
17.			
18.			
19.			
20.			
21.			
22.			
23.			
24.			
25.			
26.			

PHASE 1 - QUALIFICATION (Continued)

TRAINING STARTED DATE

PHASE 1 RECOMMENDED COMPLETION DATE

	TASK	RECOMMENDED COMPLETION DATE	DATE COMPLETED
27.			
28.			
29.			
30.			
31.			
32.			
33.			
34.			
35.			
36.			
37.			
38.			
39.			
40.			
41.			
42.			
43.			
44.			
45.			
46.			
47.			
48.			
49.			
50.			
51.			
52.			

PHASE 2 - POSITION TRAINING AND RATING

TRAINING STARTED DATE		PHASE 2 RECOMMENDED COMPLETION DATE	
TASK		RECOMMENDED COMPLETION DATE	DATE COMPLETED
1.	Initial Weather Certification (<i>USAF</i>)		
2.	Intro to Instrument Approach Procedures (<i>TERPS</i>)		
3.	Develop MVA Chart		
4.	FTM Chapters 2-4		
5.	FAAO 7110.65 Chapters 2-3 and 5		
6.	AR 95-2 Chapters 2-5 & Current AIG Messages		
7.	AR 40-8 and AR 40-501 Chapter 6		
8.	Recognize and Implement ECM and ECCM		
9.	Perform Assumption of Duty Requirements		
10.	Flips, Charts, VFR and IFR Supplements		
11.	Flight Data Procedures		
12.	FTM Chapters 5-8		
13.	A ² C ² (<i>Facility and Mission Specific</i>)		
14.	FTM Chapters 9 and 12		
15.	FM 3-04.303 Chapters 1-3		
16.	FAAO 7110.65 Chapters 4, 5, and 7		
17.	Flight Data Position Qualification		
18.	ASR/PAR Procedures		
19.	FAAO 7110.65 Chapters 7 and 10		
20.	Provide Emergency Assistance		
21.	Provide Traffic Advisories		
22.	ASR/PAR Position Qualification		
23.	Pre-ATCS Exam		
24.	FTM Chapter 13		
25.			
26.			

PHASE 2 - POSITION TRAINING AND RATING (Continued)

TRAINING STARTED DATE	PHASE 2 RECOMMENDED COMPLETION DATE
-----------------------	-------------------------------------

	TASK	RECOMMENDED COMPLETION DATE	DATE COMPLETED
27.			
28.			
29.			
30.			
31.			
32.			
33.			
34.			
35.			
36.			
37.			
38.			
39.			
40.			
41.			
42.			
43.			
44.			
45.			
46.			
47.			
48.			
49.			
50.			

NOTE 1: Those items listed above which do not apply to your unit do not need to be completed. However, as they become relevant, they shall be entered into Section III of DA Form 3479-R.

NOTE 2: The ATCS Examination is required, but it is not annotated in section III as trained.

PHASE 1 - SECTION IV ENTRIES

	TEST	RECOMMENDED COMPLETION DATE	DATE COMPLETED
1.	FTM Chapter 1		
2.	Operate/PMCS primary mover		
3.	Operate/PMCS <i>(primary power system)</i>		
4.	Install/Operate/PMCS AN/TPN-31 <i>(Includes all equipment training and Sighting Requirements)</i>		
5.	Disassembly/Storage of AN/TPN-31		
6.			
7.			
8.			
9.			
10.			
11.			
12.			
13.			
14.			
15.			
16.			
17.			
18.			
19.			
20.			
21.			
22.			
23.			
24.			
25.			
26.			
27.			

PHASE 2 - SECTION IV ENTRIES

	TEST	RECOMMENDED COMPLETION DATE	DATE COMPLETED
1.	Initial Weather Certification <i>(USAF)</i>		
2.	Intro to TERPS <i>(Includes Develop Instrument Approach Procedures and Develop MVA Chart)</i>		
3.	A ² C ² <i>(Facility and Mission Specific)</i>		
4.	FTM Chapters 2-4		
5.	FAAO 7110.65 Chapters 2-3 and 5		
6.	AR 95-2 Chapters 2-5		
7.	AR 40-8 and AR 40-501		
8.	Flips, Charts, VFR and IFR Supplements		
9.	FTM Chapters 5-8		
10.	FTM Chapters 9-12		
11.	FM 3-04.303 Chapters 1-3		
12.	FM 3-04.303 Chapters 4, 5, and 7		
13.	Flight Data Position Qualification		
14.	FAAO 7110.65 Chapters 7 and 10		
15.	ASR/PAR Position Qualification		
16.	Pre-ATCS Exam		
17.	ATCS Exam		
18.	FTM Chapter 13		
19.			
20.			
21.			
22.			
23.			
24.			
25.			
26.			
27.			

ADDITIONAL ENTRIES

	TEST/TASK	RECOMMENDED COMPLETION DATE	DATE COMPLETED
1.			
2.			
3.			
4.			
5.			
6.			
7.			
8.			
9.			
10.			
11.			
12.			
13.			
14.			
15.			
16.			
17.			
18.			
19.			
20.			
21.			
22.			
23.			

NOTE 1: Those items listed above which do not apply to your unit do not need to be completed. However, as they become relevant, they shall be entered in Section III of DA Form 3479-R.

NOTE 2: Example comments required in Remarks column:

a. Type test given: test without remarks shall be understood as written.

(1) Written, (2) Oral, (3) Practical.

b. Agency administering exam:

(1) Motor Sergeant/Master Driver (*Vehicle Licensing*), (2) USAF (*Weather Exam*)

**TACTICAL FACILITY TRAINING PROGRAM (FTP)
AN/TSQ-70A TACTICAL TOWER SYSTEM**

For use of this form, see FM 3-04.303 the proponent agency is TRADOC.

1. NAME		2. RANK	
3. OPERATING INITIALS		4. ATCS NUMBER	
5. SECURITY CLEARANCE		6. FLIGHT PHYSICAL DUE	7. DATE ASSIGNED TO UNIT
8. TRAINING START DATE		9. PHASE I COMPLETE	10. PHASE 2 COMPLETE

11. This is a standardized tactical qualification and rating checklist that will be used to follow the progress of a controller through the training program. All applicable items shall be entered in sections III and IV of DA Form 3479-R.

12. REFERENCES:

- Applicable SOP's
- Appropriate Equipment TM's
- AR 40-8/AR 40-501/AR 95-2
- ARTEP 1-425-MTP
- FAAO 7110.65
- FAAO 8200.1
- FAAO 8260.3
- Flips, Charts and IFR/VFR Supplements
- FM 1-120 (3-04.120)
- FM 3-04.303
- FM 3-52
- FTM

13. The training program consists of two phases: Phase 1 - Qualification, and Phase 2 - Position Training and Rating.

a. Phase 1 consists of individual and team training on the installation, operation and maintenance of all ATS equipment assigned to the Tactical Tower System. The training program is designed to ensure Phase 1 training is completed within 3 months (*Army National Guard 2 AT's*) of being assigned to the training program. However, as soon as a controller demonstrates proficiency in all applicable areas, phase completion may be achieved at an earlier date.

b. Phase 2 is dependent upon actual mission and the controller's ability to control "LIVE" traffic in a tactical environment. Phase 2 has no set time limit.

14. REMEDIAL TRAINING: Upon completion of phase training or rating, should an individual fail to maintain the required proficiency level, he/she will be placed on Remedial Training. If unable to successfully complete the Remedial Training in time allowed, reclassification actions will be taken.

15. CONTROLLER'S SIGNATURE		16. FACILITY CHIEF'S SIGNATURE	
----------------------------	--	--------------------------------	--

PHASE 1 - QUALIFICATION

TRAINING STARTED DATE

PHASE 1 RECOMMENDED COMPLETION DATE

TASK		RECOMMENDED COMPLETION DATE	DATE COMPLETED
1.	Intro to AN/TSQ-70A		
2.	FTM Chapter 1		
3.	Operate/PMCS Primary Mover		
4.	Operate/PMCS power system		
5.	Install/Operate/PMCS AN/TSQ-70A		
6.	AN/TSQ-70A Emergency shutdown		
7.	Disassembly/Storage of AN/TSQ-70A		
8.	Install/Operate/PMCS AN/TRN-30(v)1 Beacon <i>(Remarks: 15' and 30' Modes)</i>		
9.	Disassembly/Storage of AN/TRN-30		
10.	Operate COMSEC Equipment		
11.	Operate GPS		
12.	Operate/Maintain NVD		
13.			
14.			
15.			
16.			
17.			
18.			
19.			
20.			
21.			
22.			
23.			
24.			
25.			
26.			

PHASE 1 - QUALIFICATION (Continued)

TRAINING STARTED DATE

PHASE 1 RECOMMENDED COMPLETION DATE

	TASK	RECOMMENDED COMPLETION DATE	DATE COMPLETED
27.			
28.			
29.			
30.			
31.			
32.			
33.			
34.			
35.			
36.			
37.			
38.			
39.			
40.			
41.			
42.			
43.			
44.			
45.			
46.			
47.			
48.			
49.			
50.			
51.			
52.			

PHASE 2 - POSITION TRAINING AND RATING

TRAINING STARTED DATE		PHASE 2 RECOMMENDED COMPLETION DATE	
TASK		RECOMMENDED COMPLETION DATE	DATE COMPLETED
1.	Initial Weather Certification <i>(USAF)</i>		
2.	Install Landing "Y" / NATO "T"		
3.	Intro to Development of TAPS for NDB		
4.	FTM Chapters 2-4		
5.	FAAO 7110.65 Chapters 2-4		
6.	AR 95-2 Chapters 2-5 & Current AIG Messages		
7.	AR 40-8 and AR 40-501 Chapter 6		
8.	Recognize and Implement ECM and ECCM		
9.	Perform Assumption of Duty Requirements		
10.	Flips, Charts, VFR and IFR Supplements		
11.	Flight Data Procedures		
12.	FTM Chapters 5-8		
13.	A ² C ² <i>(Facility and Mission Specific)</i>		
14.	Process Flight Progress Strips		
15.	FTM Chapters 9 and 12		
16.	FM 3-04.303 Chapters 1-3		
17.	FM 3-04.303 Chapters 4, 5, and 7		
18.	Flight Data Position Qualification		
19.	Ground Control Procedures		
20.	FAAO 7110.65 Chapters 7 and 10		
21.	Provide Emergency Assistance		
22.	Light Gun Procedures		
23.	Ground Control Position Qualification		
24.	Local Control Procedures		
25.	Flight Following Procedures		
26.	Local Control Position Qualification		

PHASE 2 - POSITION TRAINING AND RATING (Continued)

TRAINING STARTED DATE	PHASE 2 RECOMMENDED COMPLETION DATE
-----------------------	-------------------------------------

TASK		RECOMMENDED COMPLETION DATE	DATE COMPLETED
27.	Pre-ATCS Exam		
28.	FTM Chapter 13		
29.			
30.			
31.			
32.			
33.			
34.			
35.			
36.			
37.			
38.			
39.			
40.			
41.			
42.			
43.			
44.			
45.			
46.			
47.			
48.			
49.			
50.			

NOTE 1: Those items listed above which do not apply to your unit do not need to be completed. However, as they become relevant, they shall be entered into Section III of DA Form 3479-R.

NOTE 2: The ATCS Examination is required, but it is not annotated in section III as trained.

PHASE 2 - SECTION IV ENTRIES

	TEST	RECOMMENDED COMPLETION DATE	DATE COMPLETED
1.	Initial Weather Certification <i>(USAF)</i>		
2.	Development of TAPS for NDB		
3.	FTM Chapters 2-4		
4.	FAAO 7110.65 Chapters 2-4		
5.	AR 95-2 Chapters 2-5		
6.	AR 40-8 and AR 40-501 Chapter 6		
7.	Flips, Charts, VFR and IFR Supplements		
8.	FTM Chapters 5-8		
9.	FTM Chapters 9-12		
10.	FM 3-04.303 Chapters 1, 2, and 3		
11.	FM 3-04.303 Chapters 4, 5, and 7		
12.	Flight Data Position Qualification		
13.	FAAO 7110.65 Chapters 7 and 10		
14.	Ground Control Position Qualification		
15.	Local Control Position Qualification		
16.	A ² C ² <i>(Facility and Mission Specific)</i>		
17.	Pre-ATCS Exam		
18.	ATCS Exam		
19.	FTM Chapter 13		
20.			
21.			
22.			
23.			
24.			
25.			
26.			
27.			

ADDITIONAL ENTRIES

	TEST/TASK	RECOMMENDED COMPLETION DATE	DATE COMPLETED
1.			
2.			
3.			
4.			
5.			
6.			
7.			
8.			
9.			
10.			
11.			
12.			
13.			
14.			
15.			
16.			
17.			
18.			
19.			
20.			
21.			
22.			
23.			

NOTE 1: Those items listed above which do not apply to your unit do not need to be completed. However, as they become relevant, they shall be entered in Section III of DA Form 3479-R.

NOTE 2: Example comments required in Remarks column:

- a. Type test given: test without remarks shall be understood as written.
(1) Written, (2) Oral, (3) Practical.
- b. Agency administering exam:
(1) Motor Sergeant/Master Driver (*Vehicle Licensing*), (2) USAF (*Weather Exam*)

**TACTICAL FACILITY TRAINING PROGRAM (FTP)
AN/TSQ-97A TACTICAL TOWER SYSTEM**

For use of this form, see FM 3-04.303 the proponent agency is TRADOC.

1. NAME		2. RANK	
3. OPERATING INITIALS		4. ATCS NUMBER	
5. SECURITY CLEARANCE		6. FLIGHT PHYSICAL DUE	
		7. DATE ASSIGNED TO UNIT	
8. TRAINING START DATE		9. PHASE I COMPLETE	
		10. PHASE 2 COMPLETE	

11. This is a standardized tactical qualification and rating checklist that will be used to follow the progress of a controller through the training program. All applicable items shall be entered in sections III and IV of DA Form 3479-R.

12. REFERENCES:

- Applicable SOP's
- Appropriate Equipment TM's
- AR 40-8/AR 40-501/AR 95-2
- ARTEP 1-425-MTP
- FAAO 7110.65
- FAAO 8200.1
- FAAO 8260.3
- Flips, Charts and IFR/VFR Supplements
- FM 1-120 (3-04.120)
- FM 3-04.303
- FM 3-52
- FTM

13. The training program consists of two phases: Phase 1 - Qualification, and Phase 2 - Position Training and Rating.

a. Phase 1 consists of individual and team training on the installation, operation and maintenance of all ATS equipment assigned to the Tactical Tower System. The training program is designed to ensure Phase 1 training is completed within 3 months (*Army National Guard 2 AT's*) of being assigned to the training program. However, as soon as a controller demonstrates proficiency in all applicable areas, phase completion may be achieved at an earlier date.

b. Phase 2 is dependent upon actual mission and the controller's ability to control "LIVE" traffic in a tactical environment. Phase 2 has no set time limit.

14. REMEDIAL TRAINING: Upon completion of phase training or rating, should an individual fail to maintain the required proficiency level, he/she will be placed on Remedial Training. If unable to successfully complete the Remedial Training in time allowed, reclassification actions will be taken.

15. CONTROLLER'S SIGNATURE		16. FACILITY CHIEF'S SIGNATURE	

PHASE 1 - QUALIFICATION

TRAINING STARTED DATE		PHASE 1 RECOMMENDED COMPLETION DATE	
TASK		RECOMMENDED COMPLETION DATE	DATE COMPLETED
1.	Intro to AN/TSQ-97A		
2.	FTM Chapter 1		
3.	Operate/PMCS primary power system		
4.	Install/Operate/PMCS AN/TSQ-97A		
5.	Site Selection for AN/TSQ-97A		
6.	AN/TSQ-97A Emergency shutdown		
7.	Disassembly/Storage of AN/TSQ-97A		
8.	Install/Operate/PMCS AN/TRN-30(v)1 Beacon <i>(Remarks: 15' and 30' Modes)</i>		
9.	Disassembly/Storage of AN/TSQ-30		
10.	Operate COMSEC Equipment		
11.	Operate GPS		
12.	Operate/Maintain NVD		
13.			
14.			
15.			
16.			
17.			
18.			
19.			
20.			
21.			
22.			
23.			
24.			
25.			
26.			

PHASE 1 - QUALIFICATION (Continued)

TRAINING STARTED DATE

PHASE 1 RECOMMENDED COMPLETION DATE

	TASK	RECOMMENDED COMPLETION DATE	DATE COMPLETED
27.			
28.			
29.			
30.			
31.			
32.			
33.			
34.			
35.			
36.			
37.			
38.			
39.			
40.			
41.			
42.			
43.			
44.			
45.			
46.			
47.			
48.			
49.			
50.			
51.			
52.			

PHASE 2 - POSITION TRAINING AND RATING

TRAINING STARTED DATE		PHASE 2 RECOMMENDED COMPLETION DATE	
TASK		RECOMMENDED COMPLETION DATE	DATE COMPLETED
1.	Initial Weather Certification <i>(USAF)</i>		
2.	Install Landing "Y" / NATO "T"		
3.	Intro to Development of TAPS for NDB		
4.	FTM Chapters 2-4		
5.	FAAO 7110.65 Chapters 2-4		
6.	AR 95-2 Chapters 2-5 & Current AIG Messages		
7.	AR 40-8 and AR 40-501 Chapter 6		
8.	Recognize and Implement ECM and ECCM		
9.	Perform Assumption of Duty Requirements		
10.	Flips, Charts, VFR and IFR Supplements		
11.	Flight Data Procedures		
12.	FTM Chapters 5-8		
13.	A ² C ² <i>(Facility and Mission Specific)</i>		
14.	Process Flight Progress Strips		
15.	FTM Chapters 9 and 12		
16.	FM 3-04.303 Chapters 1-3		
17.	FM 3-04.303 Chapters 4, 5, and 7		
18.	Flight Data Position Qualification		
19.	Ground Control Procedures		
20.	FAAO 7110.65 Chapters 7 and 10		
21.	Provide Emergency Assistance		
22.	HLZ Operations		
23.	Light Gun Procedures		
24.	Ground Control Position Qualification		
25.	LC Procedures		
26.	Flight Following Procedures		

PHASE 2 - POSITION TRAINING AND RATING (Continued)

TRAINING STARTED DATE		PHASE 2 RECOMMENDED COMPLETION DATE	
TASK		RECOMMENDED COMPLETION DATE	DATE COMPLETED
27.	Local Control Position Qualification		
28.	Pre-ATCS Exam		
29.	FTM Chapter 13		
30.			
31.			
32.			
33.			
34.			
35.			
36.			
37.			
38.			
39.			
40.			
41.			
42.			
43.			
44.			
45.			
46.			
47.			
48.			
49.			
50.			

NOTE 1: Those items listed above which do not apply to your unit do not need to be completed. However, as they become relevant, they shall be entered into Section III of DA Form 3479-R.

NOTE 2: The ATCS Examination is required, but it is not annotated in section III as trained.

PHASE 1 - SECTION IV ENTRIES

TEST		RECOMMENDED COMPLETION DATE	DATE COMPLETED
1.	FTM Chapter 1		
2.	Operate/PMCS primary power system		
3.	Install/Operate/PMCS AN/TSQ-97A <i>(Includes all equipment training and Sighting Requirements)</i>		
4.	Disassembly/Storage of AN/TSQ-97A		
5.	Install/Operate/PMCS AN/TRN-30(v)1 Beacon <i>(Remarks: 15' and 30' Modes)</i>		
6.			
7.			
8.			
9.			
10.			
11.			
12.			
13.			
14.			
15.			
16.			
17.			
18.			
19.			
20.			
21.			
22.			
23.			

PHASE 2 - SECTION IV ENTRIES

	TEST	RECOMMENDED COMPLETION DATE	DATE COMPLETED
1.	Initial Weather Certification <i>(USAF)</i>		
2.	HLZ Operations <i>(Includes Determine Landing Direction and Emplacement of Landing "Y" /NATO "T")</i>		
3.	Development of TAPS for NDB		
4.	FTM Chapters 2-4		
5.	FAAO 7110.65 Chapters 2-4		
6.	AR 95-2 Chapters 2-5		
7.	AR 40-8 and AR 40-501 Chapter 6		
8.	Flips, Charts, VFR and IFR Supplements		
9.	FTM Chapters 5-8		
10.	FTM Chapters 9 and 12		
11.	FM 3-04.303 Chapters 1-3		
12.	FM 3-04.303 Chapters 4, 5, and 7		
13.	Flight Data Position Qualification		
14.	FAAO 7110.65 Chapters 7 and 10		
15.	Ground Control Position Qualification		
16.	Local Control Position Qualification		
17.	A ² C ² <i>(Facility and Mission Specific)</i>		
18.	Pre-ATCS Exam		
19.	ATCS Exam		
20.	FTM Chapter 13		

ADDITIONAL ENTRIES

	TEST/TASK	RECOMMENDED COMPLETION DATE	DATE COMPLETED
1.			
2.			
3.			
4.			
5.			
6.			
7.			
8.			
9.			
10.			
11.			
12.			
13.			
14.			
15.			
16.			
17.			
18.			
19.			
20.			
21.			
22.			
23.			

NOTE 1: Those items listed above which do not apply to your unit do not need to be completed. However, as they become relevant, they shall be entered in Section III of DA Form 3479-R.

NOTE 2: Example comments required in Remarks column:

a. Type test given: test without remarks shall be understood as written.

(1) Written, (2) Oral, (3) Practical.

b. Agency administering exam:

(1) Motor Sergeant/Master Driver (*Vehicle Licensing*), (2) USAF (*Weather Exam*)

GCA OPERATIONS LOG

For use of this form, see FM 3-04.303; the proponent agency is TRADOC

1. FACILITY	2. FACILITY CHIEF'S SIGNATURE	3. PERIOD COVERED (UTC)	
		FROM	
		TO	
		HOUR	DATE
		HOUR	DATE

4. OPERATIONS - S/S = Supervised or simulated LV = Live Unsupervised/Non-simulated

FLIGHT PLAN		AIRCRAFT		RADAR ID TIME (UTC) (e)	TYPE APRCH (f)	ASR				PAR		EMER NO GYRO (m)	RELEASE TIME (UTC) (n)	REMARKS (o)
						PATTERN		FINAL		FINAL				
IFR (a)	VFR (b)	IDENT (c)	TYPE (d)			S/S (g)	LV (h)	S/S (i)	LV (j)	S/S (k)	LV (l)			
ENTER TOTALS IN COLUMNS AT LEFT. (TOTAL NUMBER OF IFR OPERATIONS) (TOTAL NUMBER OF VFR OPERATIONS)					TOTAL IFR									
					TOTAL VFR									

PRECISION APPROACH RADAR (GCA) DATA

For use of this form, see FM 3-04.303 the proponent agency is TRADOC.

1. AIRPORT NAME		2. CITY	
3. STATE		4. COUNTRY	
		5. DATE	
6a. PAR COMPONENTS AND PERTINENT RUNWAY DATA <i>(Numbered items correspond to the diagram in Item 9)</i>		6b. LATITUDE	6c. LONGITUDE
		<i>(1/100 Second)</i>	
		<i>(1/10 Feet)</i>	
(1) PAR Antenna Right of Runway			
(1a) Touchdown Reflector/RPL Reflector Right of Runway			
(2) PAR Antenna Left of Runway			
(2a) Touchdown Reflector/RPL Reflector Left of Runway			
(3) The point on runway centerline (C/L) closest to the touchdown reflector (RPI)			
(4) Runway C/L End (Landing Threshold)			
(5) Runway C/L End (Departure End of Runway)			
(6) The point of runway closest to PAR Antenna (Offset)			
(7) Displaced Threshold (if applicable)			
7. PAR GROUND DISTANCE <i>(1/10 feet)</i>			
a. 1 to 6	b. 1a to 3	c. 2 to 6	
d. 2a to 3	e. 3 to 4	f. 3 to 6	
g. 3 to 7	h. 4 to 7	i. GEODETIC AZIMUTH 4 to 5	
8. SHOW MAGNETIC NORTH ARROW HERE. Insert graphic image.			
<div style="border: 1px solid black; width: 200px; height: 80px; margin: 0 auto;"></div>			
9. DIAGRAM. Data referenced to WGS 84			
10. FACILITY CHIEF'S NAME, RANK, AND PHONE NUMBER		11. FACILITY CHIEF'S SIGNATURE	

FM 3-04.303 (FM 1-303)
3 DECEMBER 2003

By Order of the Secretary of the Army:

Official:

PETER J. SCHOOMAKER
General, United States Army
Chief of Staff



JOEL B. HUDSON
Administrative Assistant to the
Secretary of the Army

0331015

DISTRIBUTION:

Active Army, Army National Guard, and U. S. Army Reserve: To be distributed in accordance with the initial distribution number 110717, requirements for FM 3-04.303.

